



Digital Energy  
Multilin

# 369 Motor Management Relay Instruction Manual



369 Revision: 3.4x

Manual P/N: 1601-0077-BU

GE Publication Number: GEK-106288R

Copyright © 2010 GE Multilin



E83849



LISTED  
IND.CONT. EQ.  
52TL

## GE Multilin

215 Anderson Avenue, Markham, Ontario, Canada L6E 1B3

Tel: (905) 294-6222, 1-800-547-8629 (North America)

Fax: (905) 201-2098

Internet: <http://www.GEmultilin.com>



GE Multilin's Quality Management  
System is registered to  
ISO9001:2000

QMI # 005094  
UL # A3775

© 2010 GE Multilin Incorporated. All rights reserved.

GE Multilin 369 Motor Management Relay instruction manual for revision 3.4x.

369 Motor Management Relay, is a registered trademark of GE Multilin Inc.

The contents of this manual are the property of GE Multilin Inc. This documentation is furnished on license and may not be reproduced in whole or in part without the permission of GE Multilin. The content of this manual is for informational use only and is subject to change without notice.

Part numbers contained in this manual are subject to change without notice, and should therefore be verified by GE Multilin before ordering.

Part number: 1601-0077-BU (July 2010)

# Table of Contents

---

1: INTRODUCTION	ORDERING .....	1-1
	GENERAL OVERVIEW .....	1-1
	ORDERING .....	1-2
	ACCESSORIES .....	1-3
	FIRMWARE HISTORY .....	1-3
	PC PROGRAM (SOFTWARE) HISTORY .....	1-4
	369 RELAY FUNCTIONAL SUMMARY .....	1-5
	RELAY LABEL DEFINITION .....	1-8

---

2: PRODUCT DESCRIPTION	OVERVIEW .....	2-9
	GUIDEFORM SPECIFICATIONS .....	2-9
	METERED QUANTITIES .....	2-10
	PROTECTION FEATURES .....	2-10
	ADDITIONAL FEATURES .....	2-12
	SPECIFICATIONS .....	2-13
	INPUTS .....	2-13
	OUTPUTS .....	2-15
	METERING .....	2-16
	COMMUNICATIONS .....	2-17
	PROTECTION ELEMENTS .....	2-18
	MONITORING ELEMENTS .....	2-21
	CONTROL ELEMENTS .....	2-22
	ENVIRONMENTAL SPECIFICATIONS .....	2-22
	LONG-TERM STORAGE .....	2-24
	APPROVALS/CERTIFICATION .....	2-24
	TYPE TEST STANDARDS .....	2-24
	PRODUCTION TESTS .....	2-25

---

3: INSTALLATION	MECHANICAL INSTALLATION .....	3-27
	MECHANICAL INSTALLATION .....	3-27
	TERMINAL IDENTIFICATION .....	3-29
	369 RELAY TERMINAL LIST .....	3-29
	269 TO 369 RELAY CONVERSION TERMINAL LIST .....	3-31
	MTM-369 RELAY CONVERSION TERMINAL LIST .....	3-34
	MPM-369 RELAY CONVERSION TERMINAL LIST .....	3-35
	TERMINAL LAYOUT .....	3-36
	ELECTRICAL INSTALLATION .....	3-37
	TYPICAL WIRING DIAGRAM .....	3-37
	TYPICAL WIRING .....	3-37
	CONTROL POWER .....	3-38
	PHASE CURRENT (CT) INPUTS .....	3-38
	GROUND CURRENT INPUTS .....	3-39
	ZERO SEQUENCE GROUND CT PLACEMENT .....	3-40
	PHASE VOLTAGE (VT/PT) INPUTS .....	3-40
	BACKSPIN VOLTAGE INPUTS .....	3-41
	RTD INPUTS .....	3-42

DIGITAL INPUTS ..... 3-42

ANALOG OUTPUTS ..... 3-43

REMOTE DISPLAY ..... 3-43

OUTPUT RELAYS ..... 3-44

RS485 COMMUNICATIONS ..... 3-45

TYPICAL TWO-SPEED (LOW SPEED/HIGH SPEED) MOTOR WIRING ..... 3-47

TYPICAL MOTOR FORWARD/REVERSE WIRING ..... 3-49

REMOTE RTD MODULE (RRTD) ..... 3-51

    MECHANICAL INSTALLATION ..... 3-51

    ELECTRICAL INSTALLATION ..... 3-53

CT INSTALLATION ..... 3-54

    PHASE CT INSTALLATION ..... 3-54

    5 AMP GROUND CT INSTALLATION ..... 3-55

    HGF (50:0.025) GROUND CT INSTALLATION ..... 3-56

4: USER INTERFACES

FACEPLATE INTERFACE ..... 4-57

    DISPLAY ..... 4-57

    LED INDICATORS ..... 4-57

    RS232 PROGRAM PORT ..... 4-58

    KEYPAD ..... 4-58

    SETPOINT ENTRY ..... 4-59

ENERVISTA 369 SETUP INTERFACE ..... 4-60

    HARDWARE AND SOFTWARE REQUIREMENTS ..... 4-60

    INSTALLING ENERVISTA 369 SETUP ..... 4-60

CONNECTING ENERVISTA 369 SETUP TO THE RELAY ..... 4-63

    CONFIGURING SERIAL COMMUNICATIONS ..... 4-63

    USING THE QUICK CONNECT FEATURE ..... 4-65

    CONFIGURING ETHERNET COMMUNICATIONS ..... 4-65

    CONNECTING TO THE RELAY ..... 4-67

WORKING WITH SETPOINTS AND SETPOINT FILES ..... 4-69

    ENGAGING A DEVICE ..... 4-69

    ENTERING SETPOINTS ..... 4-69

    FILE SUPPORT ..... 4-71

    USING SETPOINTS FILES ..... 4-71

UPGRADING RELAY FIRMWARE ..... 4-84

    DESCRIPTION ..... 4-84

    SAVING SETPOINTS TO A FILE ..... 4-84

    LOADING NEW FIRMWARE ..... 4-84

ADVANCED ENERVISTA 369 SETUP FEATURES ..... 4-87

    TRIGGERED EVENTS ..... 4-87

    TRENDING ..... 4-87

    WAVEFORM CAPTURE (TRACE MEMORY) ..... 4-89

    MOTOR START DATA LOGGER ..... 4-91

    DATA LOGGER ..... 4-91

    MOTOR HEALTH REPORT ..... 4-97

    PHASORS ..... 4-97

    EVENT RECORDER ..... 4-99

    MODBUS USER MAP ..... 4-100

    VIEWING ACTUAL VALUES ..... 4-100

USING ENERVISTA VIEWPOINT WITH THE 369 RELAY ..... 4-102

    PLUG AND PLAY EXAMPLE ..... 4-102

## 5: SETPOINTS

OVERVIEW .....	5-107
SETPOINTS MAIN MENU .....	5-107
S1 369 SETUP .....	5-111
SETPOINT ACCESS .....	5-111
DISPLAY PREFERENCES .....	5-111
369 COMMUNICATIONS .....	5-112
REAL TIME CLOCK .....	5-115
WAVEFORM CAPTURE .....	5-116
DATA LOGGER .....	5-117
EVENT RECORDS .....	5-118
MESSAGE SCRATCHPAD .....	5-118
DEFAULT MESSAGES .....	5-119
CLEAR/PRESET DATA .....	5-120
MODIFY OPTIONS .....	5-121
FACTORY SERVICE .....	5-121
S2 SYSTEM SETUP .....	5-122
DESCRIPTION .....	5-122
CT/VT SETUP .....	5-122
MONITORING SETUP .....	5-125
BLOCK FUNCTIONS .....	5-129
OUTPUT RELAY SETUP .....	5-130
CONTROL FUNCTIONS .....	5-131
S3 OVERLOAD PROTECTION .....	5-141
DESCRIPTION .....	5-141
THERMAL MODEL .....	5-142
OVERLOAD CURVES .....	5-144
OVERLOAD ALARM .....	5-154
S4 CURRENT ELEMENTS .....	5-155
DESCRIPTION .....	5-155
SHORT CIRCUIT .....	5-155
MECHANICAL JAM .....	5-156
UNDERCURRENT .....	5-157
CURRENT UNBALANCE .....	5-158
GROUND FAULT .....	5-159
S5 MOTOR START/INHIBITS .....	5-161
DESCRIPTION .....	5-161
ACCELERATION TRIP .....	5-161
START INHIBITS .....	5-162
BACKSPIN DETECTION .....	5-163
S6 RTD TEMPERATURE .....	5-165
DESCRIPTION .....	5-165
LOCAL RTD PROTECTION .....	5-165
REMOTE RTD PROTECTION .....	5-166
OPEN RTD ALARM .....	5-169
SHORT/LOW TEMP RTD ALARM .....	5-169
LOSS OF RRTD COMMS ALARM .....	5-170
S7 VOLTAGE ELEMENTS .....	5-171
DESCRIPTION .....	5-171
UNDERVOLTAGE .....	5-171
OVERVOLTAGE .....	5-172
PHASE REVERSAL .....	5-173
UNDERFREQUENCY .....	5-175
OVERFREQUENCY .....	5-176

S8 POWER ELEMENTS ..... 5-177

- DESCRIPTION ..... 5-177
- LEAD POWER FACTOR ..... 5-178
- LAG POWER FACTOR ..... 5-179
- POSITIVE REACTIVE POWER ..... 5-179
- NEGATIVE REACTIVE POWER ..... 5-180
- UNDERPOWER ..... 5-182
- REVERSE POWER ..... 5-183

S9 DIGITAL INPUTS ..... 5-184

- DIGITAL INPUT FUNCTIONS ..... 5-184
- SPARE SWITCH ..... 5-186
- EMERGENCY RESTART ..... 5-187
- DIFFERENTIAL SWITCH ..... 5-187
- SPEED SWITCH ..... 5-188
- REMOTE RESET ..... 5-189

S10 ANALOG OUTPUTS ..... 5-190

- ANALOG OUTPUTS ..... 5-190

S11 369 TESTING ..... 5-192

- TEST OUTPUT RELAYS ..... 5-192
- TEST ANALOG OUTPUTS ..... 5-193

S12 TWO-SPEED MOTOR ..... 5-194

- DESCRIPTION ..... 5-194
- SPEED 2 OVERLOAD CURVES ..... 5-194
- SPEED 2 UNDERCURRENT ..... 5-196
- SPEED 2 ACCELERATION ..... 5-197

6: ACTUAL VALUES

OVERVIEW ..... 6-199

- ACTUAL VALUES MAIN MENU ..... 6-199

A1 STATUS ..... 6-202

- MOTOR STATUS ..... 6-202
- LAST TRIP DATA ..... 6-202
- DATA LOGGER ..... 6-203
- DIAGNOSTIC MESSAGES ..... 6-203
- START BLOCK STATUS ..... 6-204
- DIGITAL INPUT STATUS ..... 6-204
- OUTPUT RELAY STATUS ..... 6-206
- REAL TIME CLOCK ..... 6-206
- FIELD BUS SPECIFICATION STATUS ..... 6-206

A2 METERING DATA ..... 6-207

- CURRENT METERING ..... 6-207
- VOLTAGE METERING ..... 6-207
- POWER METERING ..... 6-208
- BACKSPIN METERING ..... 6-208
- LOCAL RTD ..... 6-209
- REMOTE RTD ..... 6-209
- OVERALL STATOR RTD ..... 6-210
- DEMAND METERING ..... 6-210
- PHASORS ..... 6-211

A3 LEARNED DATA ..... 6-213

- DESCRIPTION ..... 6-213
- MOTOR DATA ..... 6-213
- LOCAL RTD MAXIMUMS ..... 6-214
- REMOTE RTD MAXIMUMS ..... 6-215

	A4 STATISTICAL DATA .....	6-216
	TRIP COUNTERS .....	6-216
	MOTOR STATISTICS .....	6-217
	A5 EVENT RECORD .....	6-219
	EVENT RECORDS .....	6-219
	MODEL INFORMATION .....	6-220
	FIRMWARE VERSION .....	6-220
<hr/>		
7: APPLICATIONS	269-369 COMPARISON .....	7-221
	369 AND 269PLUS COMPARISON .....	7-221
	369 FAQs .....	7-223
	FREQUENTLY ASKED QUESTIONS (FAQs) .....	7-223
	369 DO'S AND DONT'S .....	7-227
	DO'S AND DONT'S .....	7-227
	CT SPECIFICATION AND SELECTION .....	7-230
	CT SPECIFICATION .....	7-230
	CT SELECTION .....	7-231
	PROGRAMMING EXAMPLE .....	7-233
	PROGRAMMING EXAMPLE .....	7-233
	APPLICATIONS .....	7-239
	MOTOR STATUS DETECTION .....	7-239
	SELECTION OF COOL TIME CONSTANTS .....	7-240
	THERMAL MODEL .....	7-242
	RTD BIAS FEATURE .....	7-243
	THERMAL CAPACITY USED CALCULATION .....	7-244
	START INHIBIT .....	7-246
	TWO-PHASE CT CONFIGURATION .....	7-248
	GROUND FAULT DETECTION ON UNGROUNDED SYSTEMS .....	7-250
	RTD CIRCUITRY .....	7-251
	REDUCED RTD LEAD NUMBER APPLICATION .....	7-251
	TWO WIRE RTD LEAD COMPENSATION .....	7-253
	AUTO TRANSFORMER STARTER WIRING .....	7-253
<hr/>		
8: TESTING	TEST SETUP .....	8-255
	INTRODUCTION .....	8-255
	SECONDARY INJECTION TEST SETUP .....	8-256
	HARDWARE FUNCTIONAL TESTING .....	8-257
	PHASE CURRENT ACCURACY TEST .....	8-257
	VOLTAGE INPUT ACCURACY TEST .....	8-257
	GROUND (1 A / 5 A) ACCURACY TEST .....	8-258
	50:0.025 GROUND ACCURACY TEST .....	8-258
	RTD ACCURACY TEST .....	8-259
	DIGITAL INPUTS .....	8-260
	ANALOG INPUTS AND OUTPUTS .....	8-262
	OUTPUT RELAYS .....	8-263
	ADDITIONAL FUNCTIONAL TESTING .....	8-264
	OVERLOAD CURVE TEST .....	8-264
	POWER MEASUREMENT TEST .....	8-265
	VOLTAGE PHASE REVERSAL TEST .....	8-265
	SHORT CIRCUIT TEST .....	8-267

---

APPENDIX: REVISIONS	CHANGE NOTES .....	A-269
	REVISION HISTORY .....	A-269
	WARRANTY .....	A-275
	WARRANTY INFORMATION .....	A-275

---

INDEX





# 369 Motor Management Relay

## Chapter 1: Introduction

---

### 1.1 Ordering

#### 1.1.1 General Overview

The 369 Motor Management Relay is a digital relay that provides protection and monitoring for three phase motors and their associated mechanical systems. A unique feature of the 369 Relay is its ability to 'learn' individual motor parameters and to adapt itself to each application. Values such as motor inrush current, cooling rates and acceleration time may be used to improve the 369 Relay's protective capabilities.

The 369 Relay offers optimum motor protection where other relays cannot, by using the FlexCurve™ custom overload curve, or one of the fifteen standard curves.

The 369 Relay has one RS232 front panel port and three RS485 rear ports. The Modbus RTU protocol is standard to all ports. Setpoints can be entered via the front keypad or by using the EnerVista 369 Setup software and a computer. Status, actual values and troubleshooting information are also available via the front panel display or via communications.

As an option, the 369 Relay can individually monitor up to 12 RTDs. These can be from the stator, bearings, ambient or driven equipment. The type of RTD used is software selectable. Optionally available as an accessory is the remote RTD module which can be linked to the 369 Relay via a fibre optic or RS485 connection.

The optional metering package provides VT inputs for voltage and power elements. It also provides metering of V, kW, kvar, kVA, PF, Hz, and MWhrs. Three additional user configurable analog outputs are included with this option along with one analog output included as part of the base unit.

The Back-Spin Detection (B) option enables the 369 Relay to detect the flow reversal of a pump motor and enable timely and safe motor restarting. 369 Relay options are available when ordering the relay or as upgrades to the relay in the field. Field upgrades are via an option enabling passcode available from GE Multilin, which is unique to each relay and option.

### 1.1.2 Ordering

Select the basic model and the desired features from the selection guide below:

Table 1-1:

369	*	*	*	*	*	*	*	
369								Base unit (no RTD)
	HI							50-300 VDC / 60-265 VAC control power
	LO							20-60 VDC / 20-48 VAC control power
		R						Optional 12 RTD inputs (built-in)
		0						No optional RTD inputs
			M					Optional metering package
			B					Optional backspin detection (incl. metering)
			0					No optional metering or backspin detection
				F				Optional Fiber Optic Port
				0				No optional Fiber Optic Port
					E			Optional Modbus/TCP protocol interface
					P			Optional Profibus-DP protocol interface
					P1			Optional Profibus-DPV1 protocol interface
					D			Optional DeviceNet protocol interface
					0			No optional protocol interfaces
						H		Harsh environment option
						0		No Harsh environment option
						E		Enhanced diagnostics with Enhanced faceplate
						0		No Enhanced diagnostics with Basic faceplate



- One Analog Output is available with the 369 base model. The other three Analog Outputs can be obtained by purchasing the metering or backspin options.**

The control power (HI or LO) must be specified with all orders. If a feature is not required, a 0 must be placed in the order code. All order codes have 10 digits. The 369 is available in a non-drawout version only.

**Examples: 369-HI-R-0-0-0-0-E:** 369 with HI voltage control power and 12 RTD inputs, and enhanced diagnostics

**369-LO-0-M-0-0-0-E:** 369 relay with LO voltage control power and metering option, and enhanced diagnostics

- Features available only in Enhanced option (E)**

  - Enhanced faceplate with motor status indicators
  - Motor Health Report
  - Enhanced learned data
  - Motor Start Data Logger
  - Enhanced event recorder
  - Security audit trail events

### 1.1.3 Accessories

**EnerVista 369 Setup software:** Setup and monitoring software provided free with each relay.

**RRTD:** Remote RTD Module. Connects to the 369 Relay via a fibre optic or RS485 connection. Allows remote metering and programming for up to 12 RTDs.

**F485:** Communications converter between RS232 and RS485 / fibre optic. Interfaces a PC to the relay.

**CT:** 50, 75, 100, 150, 200, 300, 350, 400, 500, 600, 750, 1000 (1 A or 5 A secondaries)

**HGF:** Ground CTs (50:0.025) used for *sensitive* earth fault detection on high resistance grounded systems.

**515:** Blocking and test module. Provides effective trip blocking and relay isolation.

**DEMO:** Metal carry case in which 369 is mounted.

**FPC15:** Remote faceplate cable, 15'.

### 1.1.4 Firmware History

Table 1–2: FIRMWARE HISTORY (Sheet 1 of 2)

FIRMWARE REVISION	BRIEF DESCRIPTION OF CHANGE	RELEASE DATE
53CMB110.000	Production Release	June 14, 1999
53CMB111.000	Changes to Backspin Detection algorithm	June 24, 1999
53CMB112.000	Changes to Backspin Detection algorithm	July 2, 1999
53CMB120.000	Capability to work with the Remote RTD module	October 15, 1999
53CMB130.000	Improvements to the Remote RTD communications	January 3, 2000
53CMB140.000	Changes to Backspin Detection algorithm and improved RS232 communications	March 27, 2000
53CMB145.000	Minor firmware changes	June 9, 2000
53CMB160.000	Profibus protocol, waveform capture, phasor display, single analog output, demand power and current, power consumption	October 12, 2000
53CMB161.000	Minor firmware changes	October 19, 2000
53CMB162.000	Minor firmware changes	November 30, 2000
53CMB170.000	Autorestart feature added	February 9, 2001
53CMB180.000	Modbus/TCP feature added	June 15, 2001

Table 1–2: FIRMWARE HISTORY (Sheet 2 of 2)

FIRMWARE REVISION	BRIEF DESCRIPTION OF CHANGE	RELEASE DATE
53CMB190.000	Number of Event Recorders increased to 250; Hottest Overall RTD value added	November 23, 2001
53CMB201.000	Added Starter Failure, MWhrs as analog output parameter, and Motor Load Averaging feature.	April 16, 2004
53CMB210.000	Added support for variable frequency drives; minor changes to Modbus TCP.	November 5, 2004
53CMB220.000	Implementation of DeviceNet protocol and starter operation monitor.	April 11, 2005
53CMB230.000	Implemented Profibus DPV1, Force Outputs and Protection Blocking.	September 19, 2005
53CMB240.000	Custom Curve enhancement, increase range from 0 to 32767 to 0 to 65534.	November 21, 2005
53CMB250.000	Implementation of start control relay timer setting for reduced voltage starting, additional Modbus address added for starts/hour lockout time remaining, correction to date and time Broadcast command Modbus addresses, fix for latched resets with multiple local/remote assigned relays, fix for repeated "Motor Stopped" and "Motor Running" events.	April 28, 2006
53CMC310.000	Profibus loss of trip, trip contact seal in undervoltage auto restart, Motor Health Report, Enhanced learned data, motor start data logger, enhanced event recorder, security audit trail events, DeviceNet enhanced polling.	June 7, 2007
53CMC320.000	2-speed motor feature, Datalogger feature, speed of last trip display, latched trip and alarm note.	March 20, 2008
53CMC330.000	Added Ethernet Loss of Comms Trip.	May 7, 2009
53CMC340.000	Added DeviceNet Loss of Comms Trip.	July 7, 2010

### 1.1.5 PC Program (Software) History

Table 1–3: SOFTWARE HISTORY

PC PROGRAM REVISION	BRIEF DESCRIPTION OF CHANGES	RELEASE DATE
1.10	Production Release	June 14, 1999
1.20	Capability to work with the Remote RTD module	October 15, 1999

Table 1-3: SOFTWARE HISTORY

PC PROGRAM REVISION	BRIEF DESCRIPTION OF CHANGES	RELEASE DATE
1.30	Capability to communicate effectively with version 1.30 firmware	January 3, 2000
1.40	Changes made for new firmware release	March 27, 2000
1.45	Changes made for new firmware release	June 9, 2000
1.60	Profibus protocol, waveform capture, phasor display, single analog output, demand power and current, power consumption	October 23, 2000
1.70	Changes made for new firmware release	February 9, 2001
1.80	Changes made for new firmware release	June 7, 2001
1.90	Changes made for new firmware release	November 23, 2001
2.00	Changes made for new firmware release	September 9, 2003
3.01	New features and enhancements	August 16, 2004
3.11	Added support for firmware revision 2.1x	November 16, 2004
3.20	Changes made for firmware revision 2.2x	April 13, 2005
3.30	Changes made for firmware revision 2.3x	September 19, 2005
3.40	Changes made for firmware revision 2.4x	November 25, 2005
3.50	Changes made for firmware revision 2.5x	May 15, 2006
3.70	Changes made for firmware revision 3.1x	June 7, 2007
3.80	Changes made for firmware revision 3.2x	March 20, 2008
3.90	Changes made for firmware revision 3.3x	May 7, 2009
4.00	Changes made for firmware revision 3.4x	July 7, 2010

### 1.1.6 369 Relay Functional Summary

The front view for all 369 Relay models is shown below, along with the rear view showing the Profibus port, the Modbus/TCP port, and the DeviceNet port.

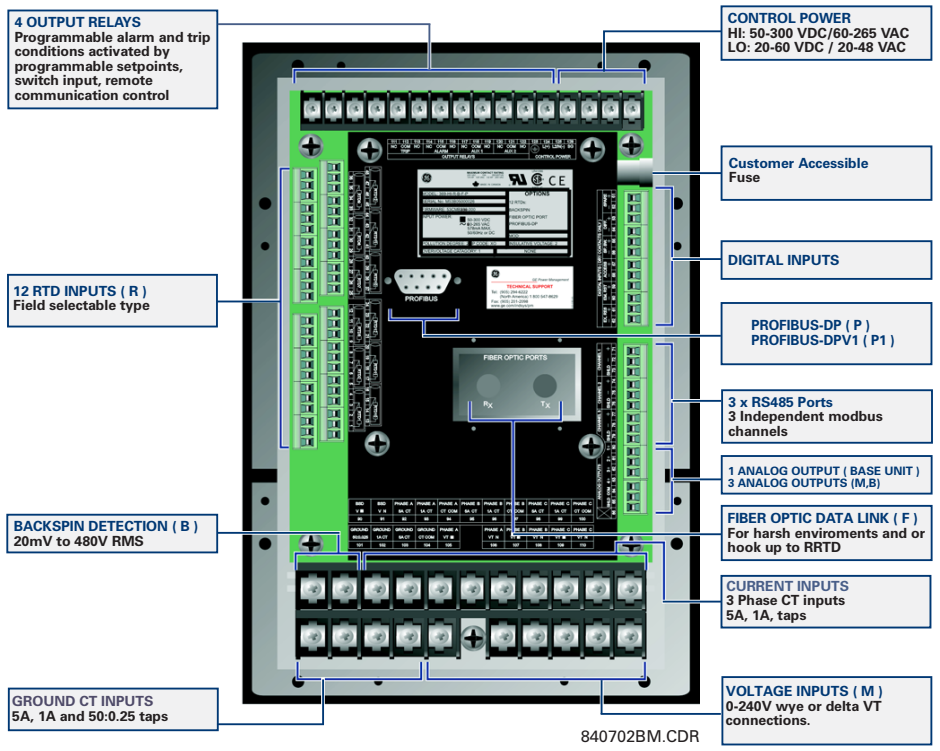
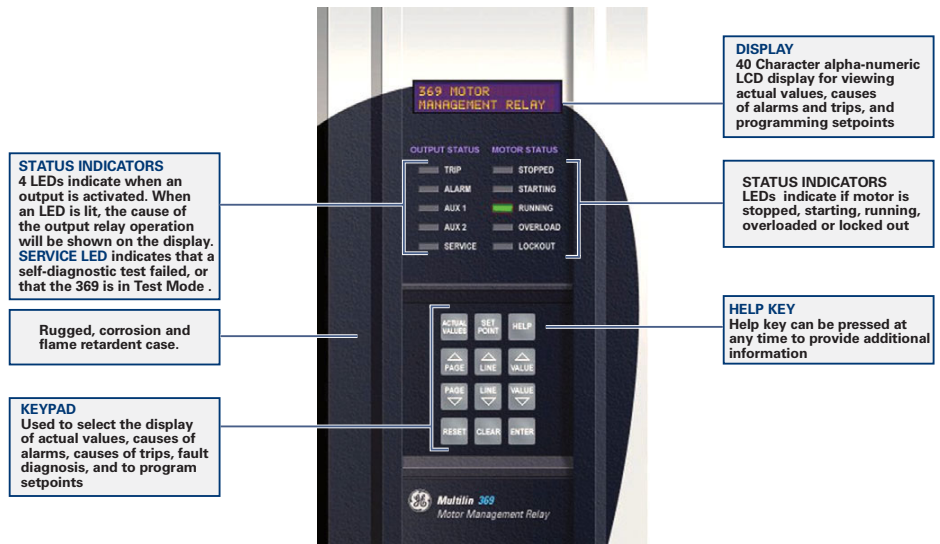

FIGURE 1-1: Front and Rear View

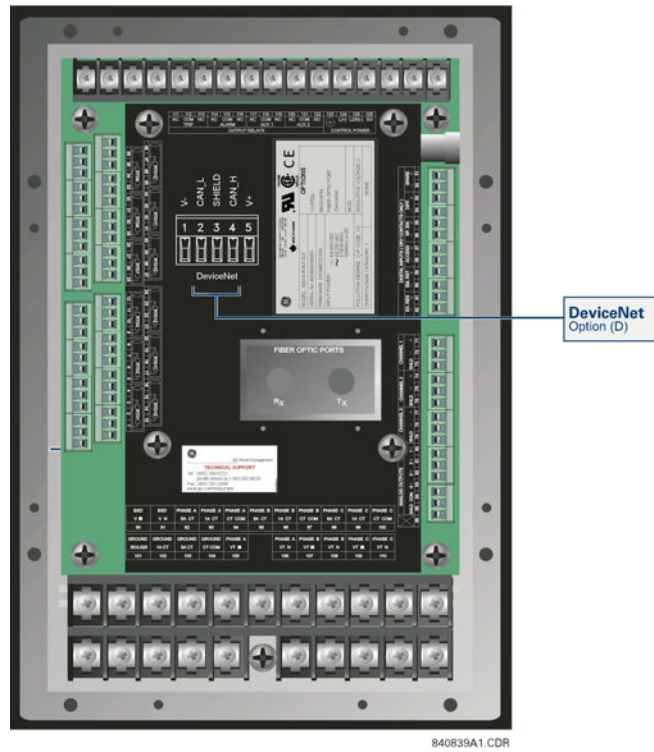

FIGURE 1-2: DeviceNet Model

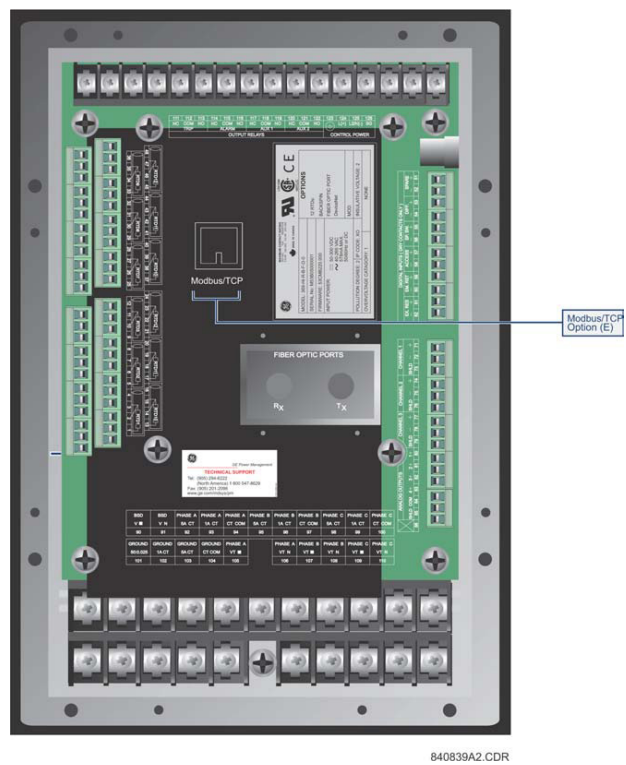
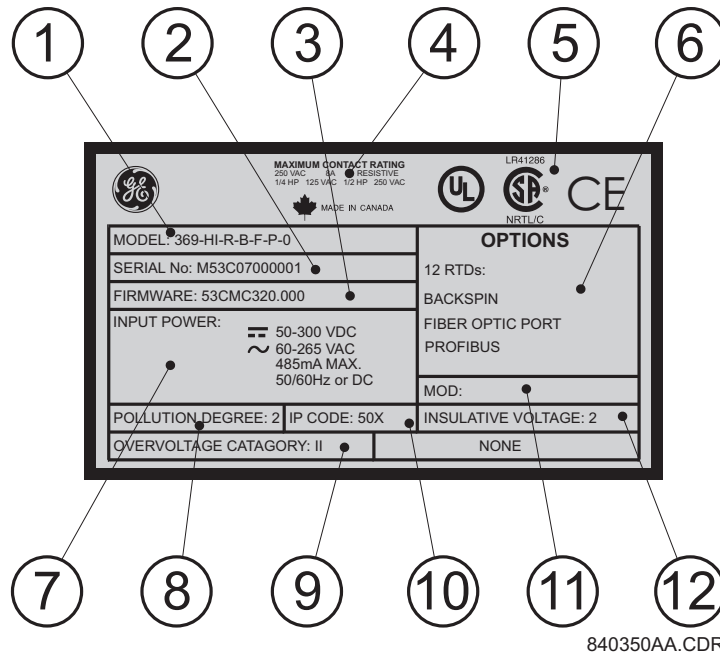

FIGURE 1-3: Rear View (Modbus/TCP Model)

1.1.7 Relay Label Definition



1. The 369 Relay order code at the time of leaving the factory.
2. The serial number of the 369 Relay.
3. The firmware installed at the factory. Note that this may no longer be the currently installed firmware as it may have been upgraded in the field. The current firmware revision can be checked in the actual values section of the 369 Relay.
4. Specifications for the output relay contacts.
5. Certifications the 369 Relay conforms with or has been approved to.
6. Factory installed options. These are based on the order code. Note that the 369 Relay may have had options upgraded in the field. The actual values section of the 369 can be checked to verify this.
7. Control power ratings for the 369 Relay as ordered. Based on the HI/LO rating from the order code.
8. Pollution degree.
9. Overvoltage category.
10. IP code.
11. Modification number for any factory-ordered mods.
12. Insulative voltage rating.





# 369 Motor Management Relay

## Chapter 2: Product Description

---

### 2.1 Overview

#### 2.1.1 Guideform Specifications

**Motor protection and management shall be provided by a digital relay. Protective functions include:**

- phase overload standard curves (51)
- overload by custom programmable curve (51)
- $I^2t$  modeling (49)
- current unbalance / single phase detection (46)
- starts per hour and time between starts
- short circuit (50)
- ground fault (50G/50N 51G/51N)
- mechanical jam / stall
- two-speed motor protection

**Optional functions include:**

- under / overvoltage (27/59)
- phase reversal (47)
- underpower (37)
- power factor (55)
- stator / bearing overtemperature with twelve (12) independent RTD inputs (49/38)
- backspin detection

**Management functions include:**

- statistical data

- pre-trip data (last 40 events)
- ability to learn, display and integrate critical parameters to maximize motor protection
- a keypad with 40 character display
- flash memory

The relay is capable of displaying important metering functions, including phase voltages, kilowatts, kvars, power factor, frequency and MWhr. In addition, undervoltage and low power factor alarm and trip levels are field programmable. The communications interface include one front RS232 port and three independent rear RS485 ports with supporting PC software, thus allowing easy setpoint programming, local retrieval of information and flexibility in communication with SCADA and engineering workstations.

### 2.1.2 Metered Quantities

METERED QUANTITY	UNITS	OPTION
Phase Currents and Current Demand	Amps	
Motor Load	× FLA	
Unbalance Current	%	
Ground Current	Amps	
Input Switch Status	Open / Closed	
Relay Output Status	(De) Energized	
RTD Temperature	°C or °F	R
Backspin Frequency	Hz	B
Phase/Line Voltages	Volts	M
Frequency	Hz	M
Power Factor	lead / lag	M
Real Power and Real Power Demand	Watts	M
Reactive Power and Reactive Power Demand	Vars	M
Apparent Power and Apparent Power Demand	VA	M
Real Power Consumption	MWh	M
Reactive Power Consumption/Generation	±Mvarh	M

### 2.1.3 Protection Features

ANSI/IEEE DEVICE	PROTECTION FEATURES	OPTION	TRIP	ALARM	BLOCK START
14	Speed Switch		•		
27	Undervoltage	M	•	•	•
37	Undercurrent / Underpower	/M	•	•	
38	Bearing RTD	R or RRTD	•	•	
46	Current Unbalance		•	•	
47	Voltage Phase Reversal	M	•		
49	Stator RTD	R or RRTD	•	•	

ANSI/ IEEE DEVICE	PROTECTION FEATURES	OPTION	TRIP	ALARM	BLOCK START
50	Short Circuit & Backup		•		
50G/51G	Ground Fault & Ground Fault Backup		•	•	
51	Overload		•	•	•
55	Power Factor	M	•	•	
59	Overvoltage	M	•	•	
66	Starts per Hour/Time Between Starts				•
74	Alarm			•	
81	Over/Under Frequency	M	•	•	
86	Lockout				•
87	Differential Switch		•		
	General Switch		•	•	
	Reactive Power	M	•	•	
	Thermal Capacity			•	
	Start Inhibit (thermal capacity available)				•
	Restart Block (Backspin Timer)				•
	Mechanical Jam		•	•	
	Acceleration Timer		•		
	Ambient RTD	R or RRTD	•	•	
	Short/Low temp RTD	R or RRTD		•	
	Broken/Open RTD	R or RRTD		•	
	Loss of RRTD Communications	RRTD		•	
	Trip Counter			•	
	Self Test/Service			•	
	Backspin Detection	B			•
	Current Demand			•	
	kW Demand	M		•	
	kvar Demand	M		•	
	kVA Demand	M		•	
	Starter Failure			•	
	Reverse Power	M		•	
	Undervoltage Autorestart	M or B			

2.1.4 Additional Features

FEATURE	OPTION
Modbus/TCP protocol Ethernet interface	E
Profibus-DP rear communication port	P
Profibus-DPV1 rear communication port	P1
DeviceNet protocol interface	D
User Definable Baud Rate (1200-19200)	
Flash Memory for easy firmware updates	
Front RS232 communication port	
Rear RS485 communication port	
Rear fiber optic port	F
RTD type is user definable	R or RRTD
4 User Definable Analog Outputs (0 to 1 mA, 0 to 20 mA, 4 to 20 mA)	M
Windows based PC program for setting up and monitoring	

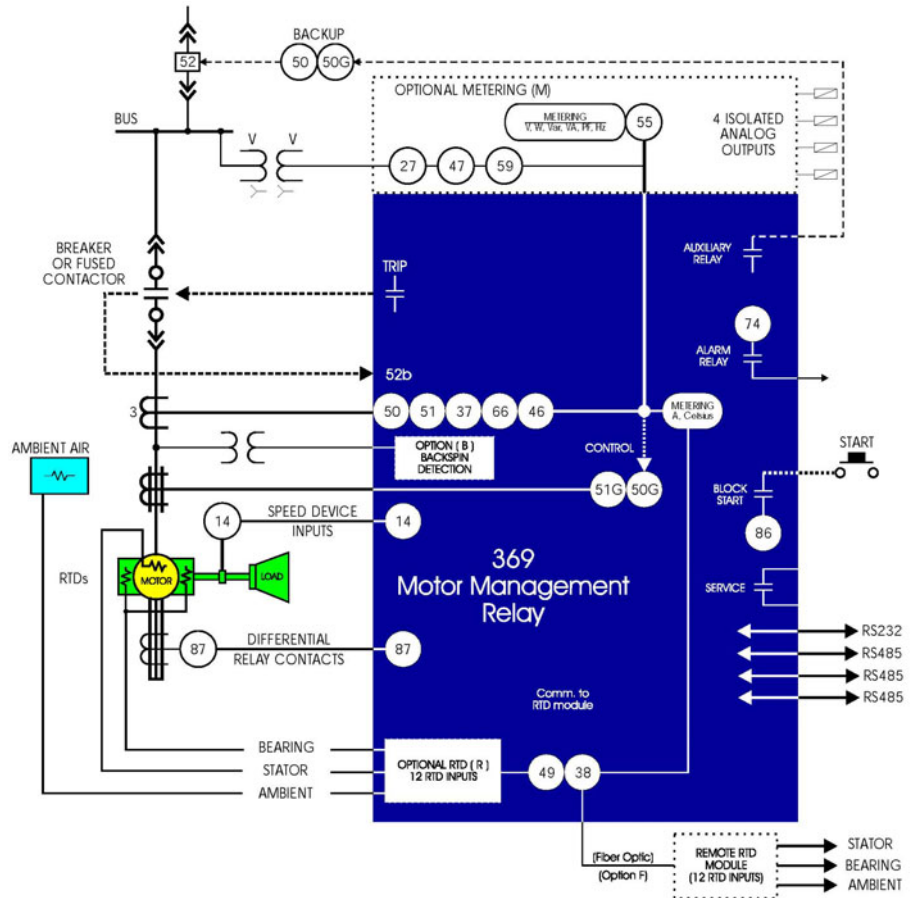

840701B1.C.DR

FIGURE 2-1: Single Line Diagram

## 2.2 Specifications

### 2.2.1 Inputs

#### CONTROL POWER

LO range:.....DC: 20 to 60 V DC  
 AC: 20 to 48 V AC at 50/60 Hz  
 HI range:.....DC: 50 to 300 V DC  
 AC: 60 to 265 V AC at 50/60 Hz  
 Power:.....nominal: 20 VA; maximum: 65 VA  
 Holdup:.....non-failsafe trip: 200 ms; failsafe trip: 100 ms

#### FUSE

T 3.15 A H 250 V (5 × 20 mm)  
 Timelag high breaking capacity

#### PHASE CURRENT INPUTS (CT)

CT input (rated):.....1 A and 5 A secondary  
 CT primary:.....1 to 5000 A  
 Range:  
 for 50/60 Hz nominal frequency: .....0.05 to 20 × CT primary amps  
 for variable frequency: .....0.1 to 20 × CT primary amps  
 Full Scale: .....20 × CT primary amps or 65535 A maximum  
 Frequency:.....20 to 100 Hz  
 Conversion: .....True RMS, 1.04 ms/sample  
 Accuracy:  
 at ≤ 2 × CT:.....±0.5% of 2 × CT for 50/60 Hz nominal freq.  
 ±1.0% of 2 × CT for variable frequency (for sinusoidal waveforms)  
 at > 2 × CT:.....±1.0% of 20 × CT for 50/60 Hz nominal freq.  
 ±3.0% of 12 × CT or less for variable frequency (for sinusoidal waveforms)

#### PHASE CT BURDEN

PHASE CT	INPUT (A)	BURDEN	
		VA	(Ω)
1 A	1	0.03	0.03
	5	0.64	0.03
	20	11.7	0.03
5 A	5	0.07	0.003
	25	1.71	0.003
	100	31	0.003

#### PHASE CT CURRENT WITHSTAND

PHASE CT	WITHSTAND TIME		
	1 s	2 s	continuous
1 A	100 × CT	40 × CT	3 × CT
5 A	100 × CT	40 × CT	3 × CT

#### DIGITAL / SWITCH INPUTS

Inputs:.....6 optically isolated  
 Input type:.....Dry Contact (< 800 Ω)  
 Function:.....Programmable



**BSD INPUTS (OPTION B)**

Frequency: ..... 1 to 120 Hz  
 Dynamic BSD range: ..... 20 mV to 480 V RMS  
 Accuracy: ..... ±0.02 Hz  
 Burden: ..... >200 kΩ

**RTD INPUTS (OPTION R)**

Wire Type: ..... 3 wire  
 Sensor Type: ..... 100 Ω platinum (DIN 43760), 100 Ω nickel, 120 Ω nickel,  
 10 Ω copper  
 RTD sensing current: ..... 3 mA  
 Range: ..... -40 to 200°C or -40 to 392°F  
 Accuracy: ..... ±2°C or ±4°F  
 Lead resistance: ..... 25 Ω max. per lead for Pt and Ni type;  
 3 Ω max. per lead for Cu type  
 Isolation: ..... 36 Vpk

**2.2.2 Outputs**

**ANALOG OUTPUTS (OPTION M)**

	PROGRAMMABLE		
<b>OUTPUT</b>	0 to 1 mA	0 to 20 mA	4 to 20 mA
<b>MAX LOAD</b>	2400 Ω	600 Ω	600 Ω
<b>MAX OUTPUT</b>	1.01 mA	20.2 mA	20.2 mA

Accuracy: ..... ±1% of full scale  
 Isolation: ..... fully isolated active source

**OUTPUT RELAYS**

	RESISTIVE LOAD (pf = 1)	INDUCTIVE LOAD (pf = 0.4)(L/ R – 7ms)
<b>RATED LOAD</b>	8 A at 250 V AC 8 A at 30 V DC	3.5 A at 250 V AC 3.5 A at 30 V DC
<b>CARRY CURRENT</b>	8A	
<b>MAX SWITCHING CAPACITY</b>	2000 VA 240 W	875 VA 170 W
<b>MAX SWITCHING V</b>	380 V AC; 125 V DC	
<b>MAX SWITCHING I</b>	8 A	3.5 A
<b>OPERATE TIME</b>	<10 ms (5 ms typical)	
<b>CONTACT MATERIAL</b>	silver alloy	



This equipment is suitable for use in Class 1, Div 2, Groups A, B, C, D or Non-Hazardous Locations only if MOD502 is ordered.



Hazardous Location – Class 1, Div 2 output rating if MOD502 is ordered: 240 V, 3 A max, as per UL1604. The contact rating is only for Make and carry operations, and shall not be used for breaking DC current.



Explosion Hazard – Substitution of components may impair suitability for Class 1, Div 2.



Explosion Hazard – Do not disconnect equipment unless power has been switched off or the area is known to be Non-Hazardous.

### 2.2.3 Metering

#### POWER METERING (OPTION M)

PARAMETER	ACCURACY (FULL SCALE)	RESOLUTION	RANGE
kW	±2%	1 kW	±32000
kvar	±2%	1 kvar	±32000
kVA	±2%	1 kVA	0 to 65000
kWh	±2%	1 kWh	0 to 999
MWh	±2%	1 MWh	0 to 65535
±kvarh	±2%	1 kvarh	0 to 999
±Mvarh	±2%	1 Mvarh	0 to 65535
Power Factor	±1%	0.01	-0.99 to 1.00
Frequency	±0.02 Hz	0.01 Hz	20.00 to 100.00
kW Demand	±2%	1 kW	0 to 32000
kvar Demand	±2%	1 kvar	0 to 32000
kVA Demand	±2%	1 kVA	0 to 65000
Amp Demand	±2%	1 A	0 to 65535

#### EVENT RECORD

Capacity:.....last 512 events  
 Triggers: .....trip, inhibit, power fail, alarms, self test, waveform capture

#### WAVEFORM CAPTURE

Length:.....3 buffers containing 16 cycles of all current and voltage channels  
 Trigger position: .....1 to 100% pre-trip to post-trip  
 Trigger: .....trip, manually via communications or digital input

#### MOTOR START DATA LOGGER

Length: .....6 Buffers containing 30 seconds of motor start data.  
 Trigger: .....Motor Start Status.  
 Trigger position: .....1-second pre-trigger duration.  
 Logging rate: .....1 sample/200ms.





**FIELD BUS LOSS OF COMMUNICATION**

Pickup:	No communication
Time delay:	0.25 to 10 sec in steps of 0.25 sec
Timing accuracy:	±250 ms for Profibus ±300 ms for Ethernet ±1000 ms for DeviceNet

**2.2.5 Protection Elements****51 OVERLOAD/STALL/THERMAL MODEL**

Curve Shape:	1 to 15 standard, custom
Curve Biasing:	unbalance, temperature, hot/cold ratio, cool time constants
Pickup Level:	1.01 to 1.25 × FLA
Pickup Accuracy:	as per phase current inputs
Dropout Level:	96 to 98% of pickup
Timing Accuracy:	±100 ms or ±2% of total trip time

**THERMAL CAPACITY ALARM**

Pickup Level:	1 to 100% TC in steps of 1
Pickup Accuracy:	±2%
Dropout Level:	96 to 98% of pickup
Timing Accuracy:	±100 ms

**OVERLOAD ALARM**

Pickup Level:	1.01 to 1.50 × FLA in steps of 0.01
Pickup Accuracy:	as per phase current inputs
Dropout Level:	96 to 98% of pickup
Time Delay:	0.1 to 60.0 s in steps of 0.1
Timing Accuracy:	±100 ms or ±2% of total trip time

**50 SHORT CIRCUIT**

Pickup Level:	2.0 to 20.0 × CT in steps of 0.1
Pickup Accuracy:	as per phase current inputs
Dropout Level:	96 to 98% of pickup
Time Delay:	0 to 255.00 s in steps of 0.01 s
Backup Delay:	0.10 to 255.00 s in steps of 0.01 s
Timing Accuracy:	+50 ms for delays <50 ms ±100 ms or ±0.5% of total trip time

**MECHANICAL JAM**

Pickup Level:	1.01 to 6.00 × FLA in steps of 0.01
Pickup Accuracy:	as per phase current inputs
Dropout Level:	96 to 98% of pickup
Time Delay:	0.5 to 125.0 s in steps of 0.5
Timing Accuracy:	±250 ms or ±0.5% of total trip time

**37 UNDERCURRENT**

Pickup Level:	0.10 to 0.99 × FLA in steps of 0.01
Pickup Accuracy:	as per phase current inputs
Dropout Level:	102 to 104% of pickup
Time Delay:	1 to 255 s in steps of 1
Start Delay:	0 to 15000 s in steps of 1
Timing Accuracy:	±500 ms or ±0.5% of total time



Dropout Level:.....96 to 98% of pickup  
 Time Delay:.....0.0 to 255.0 s in steps of 0.1  
 Timing Accuracy:..... $\pm 100$  ms or  $\pm 0.5\%$  of total trip time

**47 PHASE REVERSAL**

Pickup Level: .....phase reversal detected  
 Time Delay:.....500 to 700 ms

**81 UNDERFREQUENCY**

Pickup Level: .....20.00 to 70.00 Hz in steps of 0.01  
 Pickup Accuracy: ..... $\pm 0.02$  Hz  
 Dropout Level:.....0.05 Hz  
 Time Delay:.....0.0 to 255.0 s in steps of 0.1  
 Start Delay:.....0 to 5000 s in steps of 1  
 Timing Accuracy:..... $\pm 100$  ms or  $\pm 0.5\%$  of total trip time

**81 OVERFREQUENCY**

Pickup Level: .....20.00 to 70.00 Hz in steps of 0.01  
 Pickup Accuracy: ..... $\pm 0.02$  Hz  
 Dropout Level:.....0.05 Hz  
 Time Delay:.....0.0-255.0 s in steps of 0.1  
 Start Delay:.....0-5000 s in steps of 1  
 Timing Accuracy:..... $\pm 100$  ms or  $\pm 0.5\%$  of total trip time

**55 LEAD POWER FACTOR**

Pickup Level: .....0.99 to 0.05 in steps of 0.01  
 Pickup Accuracy: ..... $\pm 0.02$   
 Dropout Level:.....0.03 of pickup  
 Time Delay:.....0.1 to 255.0 s in steps of 0.1  
 Start Delay:.....0 to 5000 s in steps of 1  
 Timing Accuracy:..... $\pm 300$  ms or  $\pm 0.5\%$  of total trip time

**55 LAG POWER FACTOR**

Pickup Level: .....0.99 to 0.05 in steps of 0.01  
 Pickup Accuracy: ..... $\pm 0.02$   
 Dropout Level:.....0.03 of pickup  
 Time Delay:.....0.1 to 255.0 s in steps of 0.1  
 Start Delay:.....0 to 5000 s in steps of 1  
 Timing Accuracy:..... $\pm 300$  ms or  $\pm 0.5\%$  of total trip time

**POSITIVE REACTIVE POWER**

Pickup Level: .....1 to 25000 in steps of 1  
 Pickup Accuracy: ..... $\pm 2\%$   
 Dropout Level:.....96 to 98% of pickup  
 Time Delay:.....0.1 to 255.0 s in steps of 0.1  
 Start Delay:.....0 to 5000 s in steps of 1  
 Timing Accuracy:..... $\pm 300$  ms or  $\pm 0.5\%$  of total trip time

**NEGATIVE REACTIVE POWER**

Pickup Level: .....1 to 25000 kvar in steps of 1  
 Pickup Accuracy: ..... $\pm 2\%$   
 Dropout Level:.....96 to 98% of pickup  
 Time Delay:.....0.1 to 255.0 s in steps of 0.1  
 Start Delay:.....0 to 5000 s in steps of 1  
 Timing Accuracy:..... $\pm 300$  ms or  $\pm 0.5\%$  of total trip time

**37 UNDERPOWER**

Pickup Level: .....1 to 25000 kW in steps of 1  
 Pickup Accuracy: ..... $\pm 2\%$

Dropout Level:.....102 to 104% of pickup  
 Time Delay: .....0.5 to 255.0 s in steps of 0.5  
 Start Delay:.....0 to 15000 s in steps of 1  
 Timing Accuracy:..... $\pm 300$  ms or  $\pm 0.5\%$  of total trip time

**REVERSE POWER**

Pickup Level: .....1 to 25000 kW in steps of 1  
 Pickup Accuracy: ..... $\pm 2\%$   
 Dropout Level:.....96 to 98% of pickup  
 Time Delay: .....0.5 to 30.0 s in steps of 0.5  
 Start Delay:.....0 to 50000 s in steps of 1  
 Timing Accuracy:..... $\pm 300$  ms or  $\pm 0.5\%$  of total trip time

**87 DIFFERENTIAL SWITCH**

Time Delay: .....<200 ms

**14 SPEED SWITCH**

Time Delay: .....0.5 to 100.0 s in steps of 0.5  
 Timing Accuracy:..... $\pm 200$  ms or  $\pm 0.5\%$  of total trip time

**GENERAL SWITCH**

Time Delay: .....0.1 to 5000.0 s in steps of 0.1  
 Start Delay:.....0 to 5000 s in steps of 1  
 Timing Accuracy:..... $\pm 200$  ms or  $\pm 0.5\%$  of total trip time

**DIGITAL COUNTER**

Pickup: .....on count equaling level  
 Time Delay: .....<200 ms

**BACKSPIN DETECTION**

Dynamic BSD:.....20 mV to 480 V RMS  
 Pickup Level: .....3 to 120 Hz in steps of 1  
 Dropout Level:.....2 to 30 Hz in steps of 1  
 Level Accuracy: ..... $\pm 0.02$  Hz  
 Timing Accuracy:..... $\pm 500$  ms or  $\pm 0.5\%$  of total trip time

**2.2.6 Monitoring Elements****STARTER FAILURE**

Pickup level: .....motor run condition when tripped  
 Dropout level:.....motor stopped condition  
 Time delay:.....10 to 1000 ms in steps of 10  
 Timing accuracy:..... $\pm 100$  ms

**CURRENT DEMAND ALARM**

Demand period: .....5 to 90 min. in steps of 1  
 Pickup level: .....0 to 65000 A in steps of 1  
 Pickup accuracy: .....as per phase current inputs  
 Dropout level:.....96 to 98% of pickup  
 Time delay:.....<2 min.

**kW DEMAND ALARM**

Demand period: .....5 to 90 min. in steps of 1  
 Pickup level: .....1 to 50000 kW in steps of 1  
 Pickup accuracy: ..... $\pm 2\%$   
 Dropout level:.....96 to 98% of pickup  
 Time delay:.....<2 min.

**kvar DEMAND ALARM**

Demand period: .....5 to 90 min. in steps of 1



**OVERVOLTAGE CATEGORY II**

**CLEANING**

May be cleaned with a damp cloth.

### 2.2.9 Long-term storage

#### LONG-TERM STORAGE

Environment: ..... In addition to the above environmental considerations, the relay should be stored in an environment that is dry, corrosive-free, and not in direct sunlight.

Correct storage: ..... Prevents premature component failures caused by environmental factors such as moisture or corrosive gases. Exposure to high humidity or corrosive environments will prematurely degrade the electronic components in any electronic device regardless of its use or manufacturer, unless specific precautions, such as those mentioned in the Environmental section above, are taken.



**It is recommended that all relays be powered up once per year, for one hour continuously, to avoid deterioration of electrolytic capacitors and subsequent relay failure.**

### 2.2.10 Approvals/Certification

ISO: ..... Designed and manufactured to an ISO9001 registered process.

UL: ..... UL Listed (File E234799\*)  
 (File E83849)  
 UL 508 - Industrial Control Equipment  
 UL 1053 - Ground Fault Protection Equipment  
 UL 1604\* - Electrical Equipment for use in Class 1 Div 2 Hazardous Locations

CSA: ..... Certified per: C22.2 No. 142 - Process Control Equipment  
 C22.2 No. 213\* - Non-incendive Electrical Equipment for use in class 1 Div 2 Hazardous Locations

CE: ..... Conforms to EN 55011/CISPR 11, EN50082-2, IEC 947-1, 1010-1

\* For MOD502 only

DeviceNet CONFORMANCE TESTED™



### 2.2.11 Type Test Standards

#### SURGE WITHSTAND CAPABILITY

ANSI/IEEE C37.90.1 Oscillatory (2.5 kV/1 MHz)  
 ANSI/IEEE C37.90.1 Fast Rise (5 kV/10 ns)  
 IEC / EN 61000-4-4, Level 4

#### INSULATION RESISTANCE

IEC / EN 60255-5

#### IMPULSE TEST

IEC / EN 60255-5

DIELECTRIC STRENGTH: ..... ANSI/IEEE C37.90  
 IEC / EN 60255-5  
 CSA C22.2 No.14



**ELECTROSTATIC DISCHARGE**

EN 61000-4-2, Level 2  
IEC 60255-22-2 Level 2

**SURGE IMMUNITY**

IEC 1000-4-5, EN 61000-4-5  
IEC 60255-22-5

**CURRENT WITHSTAND**

ANSI/IEEE C37.90  
IEC 60255-6

**RFI**

ANSI/IEEE C37.90.2, 35 V/m  
EN 61000-4-3 10V/m  
CONDUCTED IMMUNITY:.....IEC 1000-4-6  
IEC 60255-22-6

**CONDUCTED/RADIATED EMISSIONS**

EN 55011 (IEC CISPR 11)

**ENVIRONMENTAL**

ANSI/IEEE C37.90  
IEC 60255-6  
IEC 60068-2-38 Part 2  
IEC60068-2-1, 16h at -40°C  
IEC60068-2-2, 16h at +85°C  
IEC60068-2-30, 95% variant 1, 6 days

**VIBRATION**

IEC 60255-21-1 Class 1  
IEC 60255-21-2 Class 1

**VOLTAGE DEVIATION**

IEC 1000-4-11 / EN 61000-4-11

**MAGNETIC FIELD IMMUNITY**

IEC 1000-4-8 / EN61000-4-8

**T-CODE RATING**

T4A

**2.2.12 Production Tests****DIELECTRIC STRENGTH**

All high voltage inputs at 2.2 kV AC for 1 second

**BURN IN**

8 hours at 60°C sampling plan

**CALIBRATION AND FUNCTIONALITY**

100% hardware functionality tested  
100% calibration of all metered quantities





# 369 Motor Management Relay

## Chapter 3: Installation

### 3.1 Mechanical Installation

#### 3.1.1 Mechanical Installation

The 369 is contained in a compact plastic housing with the keypad, display, communication port, and indicators/targets on the front panel. The unit should be positioned so the display and keypad are accessible. To mount the relay, make cutout and drill mounting holes as shown below. Mounting hardware (bolts and washers) is provided with the relay. Although the relay is internally shielded to minimize noise pickup and interference, it should be mounted away from high current conductors or sources of strong magnetic fields.

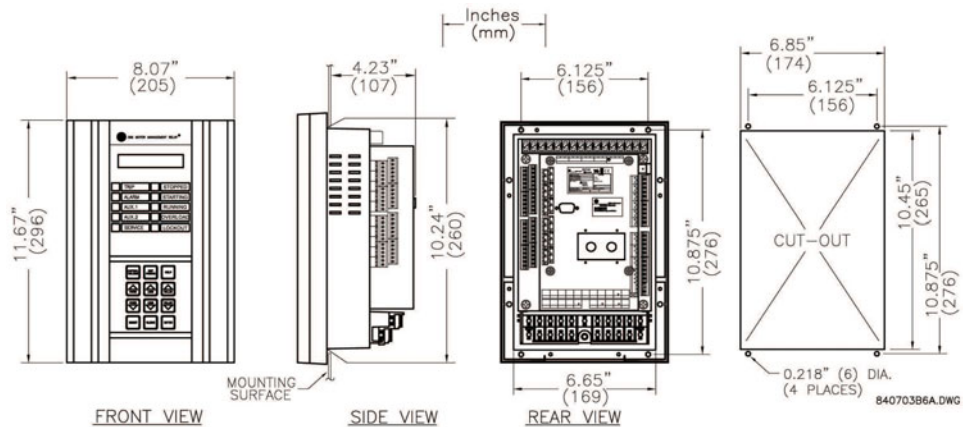

FIGURE 3-1: Physical Dimensions

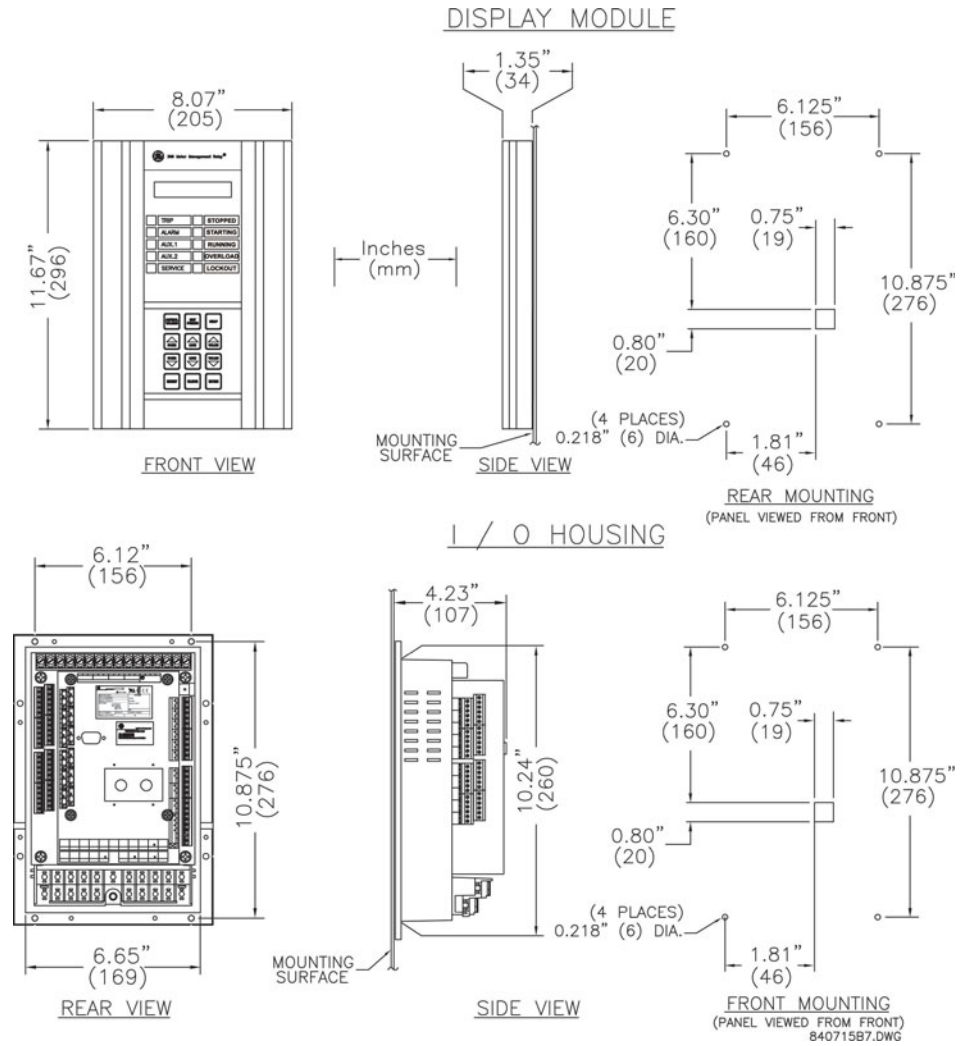

FIGURE 3-2: Split Mounting Dimensions

## 3.2 Terminal Identification

### 3.2.1 369 Relay Terminal List

TERMINAL	WIRING CONNECTION
1	RTD1 +
2	RTD1 -
3	RTD1 COMPENSATION
4	RTD1 SHIELD
5	RTD2 +
6	RTD2 -
7	RTD2 COMPENSATION
8	RTD2 SHIELD
9	RTD3 +
10	RTD3 -
11	RTD3 COMPENSATION
12	RTD3 SHIELD
13	RTD4 +
14	RTD4 -
15	RTD4 COMPENSATION
16	RTD4 SHIELD
17	RTD5 +
18	RTD5 -
19	RTD5 COMPENSATION
20	RTD5 SHIELD
21	RTD6 +
22	RTD6 -
23	RTD6 COMPENSATION
24	RTD6 SHIELD
25	RTD7 +
26	RTD7 -
27	RTD7 COMPENSATION
28	RTD7 SHIELD
29	RTD8 +
30	RTD8 -
31	RTD8 COMPENSATION
32	RTD8 SHIELD
33	RTD9 +
34	RTD9 -
35	RTD9 COMPENSATION
36	RTD9 SHIELD
37	RTD10 +
38	RTD10 -
39	RTD10 COMPENSATION
40	RTD10 SHIELD
41	RTD11 +
42	RTD11 -
43	RTD11 COMPENSATION

TERMINAL	WIRING CONNECTION
44	RTD11 SHIELD
45	RTD12 +
46	RTD12 -
47	RTD12 COMPENSATION
48	RTD12 SHIELD
51	SPARE SW
52	SPARE SW COMMON
53	DIFFERENTIAL INPUT SW
54	DIFFERENTIAL INPUT SW COMMON
55	SPEED SW
56	SPEED SW COMMON
57	ACCESS SW
58	ACCESS SW COMMON
59	EMERGENCY RESTART SW
60	EMERGENCY RESTART SW COMMON
61	EXTERNAL RESET SW
62	EXTERNAL RESET SW COMMON
71	COMM1 RS485 +
72	COMM1 RS485 -
73	COMM1 SHIELD
74	COMM2 RS485 +
75	COMM2 RS485 -
76	COMM2 SHIELD
77	COMM3 RS485 +
78	COMM3 RS485 -
79	COMM3 SHIELD
80	ANALOG OUT 1
81	ANALOG OUT 2
82	ANALOG OUT 3
83	ANALOG OUT 4
84	ANALOG COM
85	ANALOG SHIELD
90	BACKSPIN VOLTAGE
91	BACKSPIN NEUTRAL
92	PHASE A CURRENT 5A
93	PHASE A CURRENT 1A
94	PHASE A COMMON
95	PHASE B CURRENT 5A
96	PHASE B CURRENT 1A
97	PHASE B COMMON
98	PHASE C CURRENT 5A
99	PHASE C CURRENT 1A
100	PHASE C COMMON
101	NEUT/GND CURRENT 50:0.025A
102	NEUT/GND CURRENT 1A
103	NEUT/GND CURRENT 5A
104	NEUT/GND COMMON
105	PHASE A VOLTAGE
106	PHASE A NEUTRAL

TERMINAL	WIRING CONNECTION
107	PHASE B VOLTAGE
108	PHASE B NEUTRAL
109	PHASE C VOLTAGE
110	PHASE C NEUTRAL
111	TRIP NC
112	TRIP COMMON
113	TRIP NO
114	ALARM NC
115	ALARM COMMON
116	ALARM NO
117	AUX1 NC
118	AUX1 COMMON
119	AUX1 NO
120	AUX2 NC
121	AUX2 COMMON
122	AUX2 NO
123	POWER FILTER GROUND
124	POWER LINE
125	POWER NEUTRAL
126	POWER SAFETY

### 3.2.2 269 to 369 Relay Conversion Terminal List

269	WIRING CONNECTION	369
1	RTD1 +	1
2	RTD1 COMPENSATION	3
3	RTD1 -	2
4	RTD1 SHIELD	4
5	RTD2 +	5
6	RTD2 COMPENSATION	7
7	RTD2 -	6
8	RTD2 SHIELD	8
9	RTD3 +	9
10	RTD3 COMPENSATION	11
11	RTD3 -	10
12	RTD3 SHIELD	12
71	RTD4 +	13
70	RTD4 COMPENSATION	15
69	RTD4 -	14
68	RTD4 SHIELD	16
67	RTD5 +	17
66	RTD5 COMPENSATION	19
65	RTD5 -	18
64	RTD5 SHIELD	20
63	RTD6 +	21

269	WIRING CONNECTION	369
62	RTD6 COMPENSATION	23
61	RTD6 -	22
60	RTD6 SHIELD	24
13	RTD7 +	25
14	RTD7 COMPENSATION	27
15	RTD7 -	26
16	RTD7 SHIELD	28
17	RTD8 +	29
18	RTD8 COMPENSATION	31
19	RTD8 -	30
20	RTD8 SHIELD	32
21	RTD9 +	33
22	RTD9 COMPENSATION	35
23	RTD9 -	34
24	RTD9 SHIELD	36
25	RTD10 +	37
26	RTD10 COMPENSATION	39
27	RTD10 -	38
28	RTD10 SHIELD	40
44	SPARE SW	51
45	SPARE SW COMMON	52
48	DIFFERENTIAL INPUT SW	53
49	DIFFERENTIAL INPUT SW COMMON	54
50	SPEED SW	55
51	SPEED SW COMMON	56
52	ACCESS SW	57
53	ACCESS SW COMMON	58
54	EMERGENCY RESTART SW	59
55	EMERGENCY RESTART SW COM	60
56	EXTERNAL RESET SW	61
57	EXTERNAL RESET SW COMMON	62
47	COMM1 RS485 +	71
46	COMM1 RS485 -	72
88	COMM1 SHIELD	73
59	ANALOG OUT 1	80
58	ANALOG COMMON	84
83	PHASE A CURRENT 1A	93
82	PHASE A COMMON	94
81	PHASE A CURRENT 5A	92
80	PHASE B CURRENT 1A	96
79	PHASE B COMMON	97
78	PHASE B CURRENT 5A	95
77	PHASE C CURRENT 1A	99



269	WIRING CONNECTION	369
76	PHASE C COMMON	100
75	PHASE C CURRENT 5A	98
73	NEUTRAL/GROUND COMMON	104
72	NEUTRAL/GROUND CURRENT 5A	103
74	NEUT/GND CURRENT 50:0.025A	101
29	TRIP NC	111
30	TRIP COMMON	112
31	TRIP NO	113
32	ALARM NC	114
33	ALARM COMMON	115
34	ALARM NO	116
35	AUX1 NC	117
36	AUX1 COMMON	118
37	AUX1 NO	119
38	AUX2 NC	120
39	AUX2 COMMON	121
40	AUX2 NO	122
42	POWER FILTER GROUND	123
41	POWER LINE	124
43	POWER NEUTRAL	125
<b>Terminals not available on the 369</b>		
84	MTM B+	N/A
85	MTM A-	N/A

### 3.2.3 MTM-369 Relay Conversion Terminal List

MTM	WIRING CONNECTION	369
1	POWER FILTER GROUND	123
2	PHASE A VOLTAGE	105
3	PHASE B VOLTAGE	107
4	PHASE B VOLTAGE	107
5	PHASE C VOLTAGE	109
6	PHASE A COM	94
7	PHASE A CURRENT 5A	92
8	PHASE A CURRENT 1A	93
9	PHASE B COM	97
10	PHASE B CURRENT 5A	95
11	PHASE B CURRENT 1A	96
12	PHASE C COM	100
13	PHASE C CURRENT 5A	98
14	PHASE C CURRENT 1A	99
15	COMM1 RS485 +	71
16	COMM1 RS485 -	72
17	COMM1 SHIELD	73
18	ANALOG OUT 1	80
19	ANALOG OUT1 COM	84
20	ANALOG OUT 2	81
21	ANALOG OUT 2 COM	84
22	ANALOG OUT 3	82
23	ANALOG OUT 3 COM	84
24	ANALOG OUT 4	83
25	ANALOG OUT 4 COM	84
26	ANALOG SHIELD	85
27	ALARM NC	114
28	ALARM COM	115
29	ALARM NO	116
31	SPARE SW	51
32	SPARE SW COM	52
34	POWER LINE	124
35	POWER NEUTRAL	125
<b>Terminals not available on the 369:</b>		
30	PULSE OUTPUT (P/O)	N/A
33	SW.B	N/A

### 3.2.4 MPM-369 Relay Conversion Terminal List

MPM	WIRING CONNECTION	369
1	PHASE A VOLTAGE	105
2	PHASE B VOLTAGE	107
3	PHASE C VOLTAGE	109
4	PHASE NEUTRAL	108
5	POWER FILTER GROUND	123
6	POWER SAFETY	126
7	POWER NEUTRAL	125
8	POWER LINE	124
9	PHASE A CURRENT 5A	92
10	PHASE A CURRENT 1A	93
11	PHASE A COM	94
12	PHASE B CURRENT 5A	95
13	PHASE B CURRENT 1A	96
14	PHASE B COM	97
15	PHASE C CURRENT 5A	98
16	PHASE C CURRENT 1A	99
17	PHASE C COM	100
28	ANALOG OUT 1	80
27	ANALOG OUT 2	81
26	ANALOG OUT 3	82
25	ANALOG OUT 4	83
24	ANALOG COM	84
21	ANALOG SHIELD	85
43	ALARM NC	114
44	ALARM COM	115
45	ALARM NO	116
46	COMM1 SHIELD	73
47	COMM1 RS485 -	72
48	COMM1 RS485 +	71
<b>Terminals not available on the 369</b>		
31	SWITCH INPUT 1	N/A
32	SWITCH INPUT 2	N/A
33	SWITCH COM	N/A

### 3.2.5 Terminal Layout

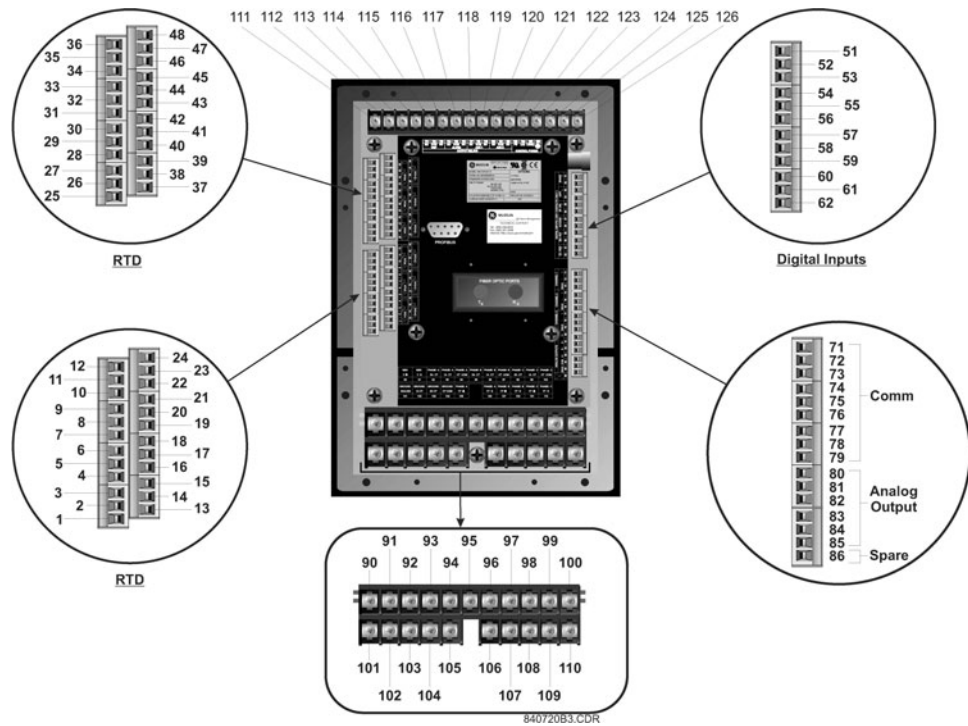

FIGURE 3-3: TERMINAL LAYOUT

### 3.3 Electrical Installation

#### 3.3.1 Typical Wiring Diagram

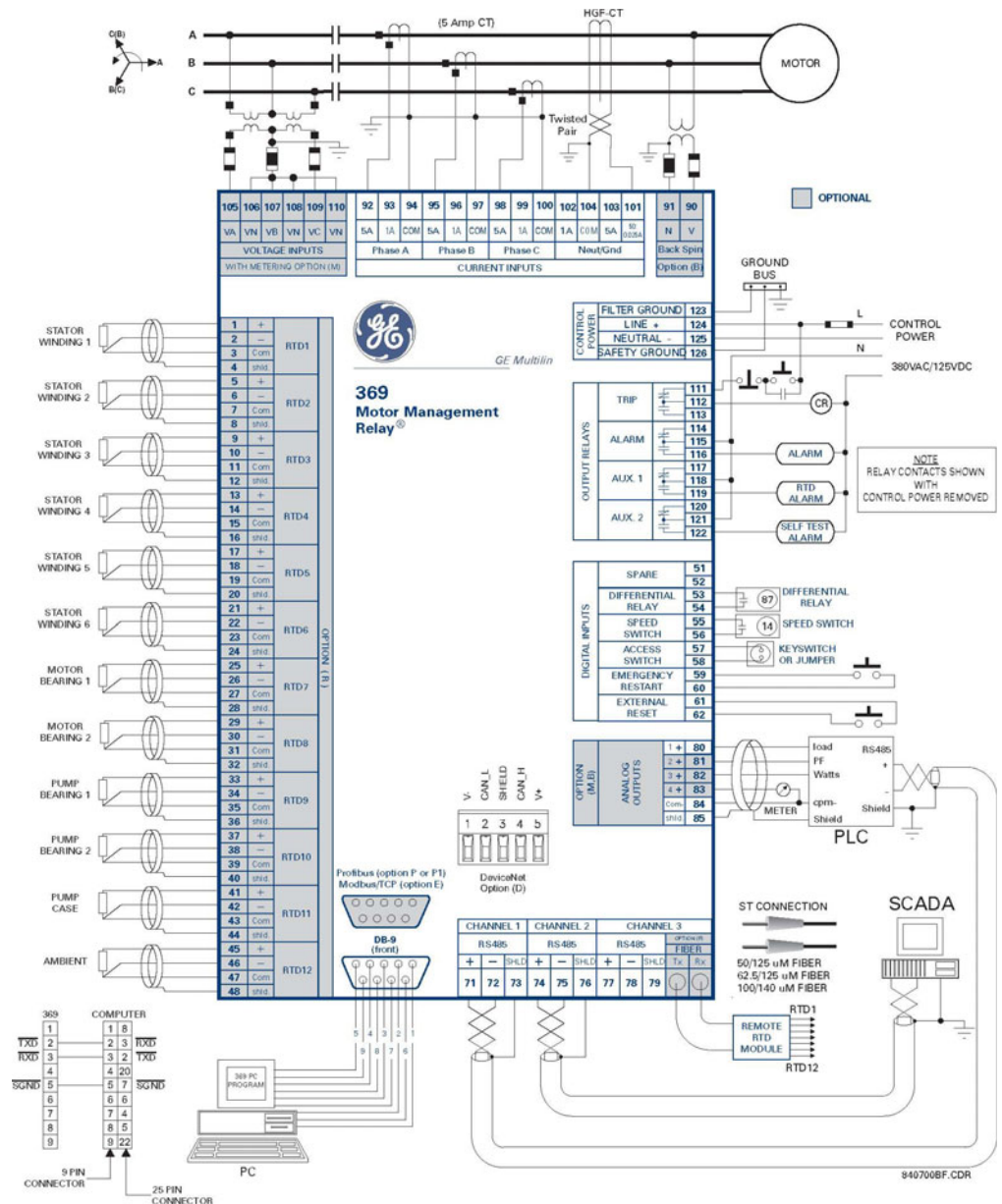

FIGURE 3-4: Typical Wiring for Motor Forward/Reversing Application

#### 3.3.2 Typical Wiring

The 369 can be connected to cover a broad range of applications and wiring will vary depending upon the user’s protection scheme. This section will cover most of the typical 369 interconnections.

In this section, the terminals have been logically grouped together for explanatory purposes. A typical wiring diagram for the 369 is shown above in FIGURE 3-4: *Typical Wiring for Motor Forward/Reversing Application* on page 3-37 and the terminal arrangement has been detailed in FIGURE 3-3: *TERMINAL LAYOUT* on page 3-36. For further information on applications not covered here, refer to Chapter : Applications or contact the factory for further information.



**Hazard may result if the product is not used for intended purposes. This equipment can only be serviced by trained personnel.**



**Do not run signal wires in the same conduit or bundle that carries power mains or high level voltage or currents.**

### 3.3.3 Control Power



**VERIFY THAT THE CONTROL POWER SUPPLIED TO THE RELAY IS WITHIN THE RANGE COVERED BY THE ORDERED 369 RELAY'S CONTROL POWER.**

**Table 3-1: 369 POWER SUPPLY RANGES**

<b>369 POWER SUPPLY</b>	<b>AC RANGE</b>	<b>DC RANGE</b>
HI	60 to 265 V	50 to 300 V
LO	20 to 48 V	20 to 60 V

The 369 has a built-in switchmode supply. It can operate with either AC or DC voltage applied to it. The relay reboot time of the 369 is 2 seconds after the control power is applied. For applications where the control power for the 369 is available from the same AC source as that of the motor, it is recommended an uninterrupted power supply be used to power up the relay or, alternatively, use a separate DC source to power up.

Extensive filtering and transient protection has been incorporated into the 369 to ensure reliable operation in harsh industrial environments. Transient energy is removed from the relay and conducted to ground via the ground terminal. This terminal must be connected to the cubicle ground bus using a 10 AWG wire or a ground braid. Do not daisy-chain grounds with other relays or devices. Each should have its own connection to the ground bus.

The internal supply is protected via a 3.15 A slo-blo fuse that is accessible for replacement. If it must be replaced ensure that it is replaced with a fuse of equal size (see *FUSE* on page 2-13).

### 3.3.4 Phase Current (CT) Inputs

The 369 requires one CT for each of the three motor phase currents to be input into the relay. There are no internal ground connections for the CT inputs. Refer to Chapter : Applications for information on two CT connections.

The phase CTs should be chosen such that the FLA of the motor being protected is no less than 50% of the rated CT primary. Ideally, to ensure maximum accuracy and resolution, the CTs should be chosen such that the FLA is 100% of CT primary or slightly less. The maximum CT primary is 5000 A.

The 369 will measure 0.05 to 20 × CT primary rated current. The CTs chosen must be capable of driving the 369 burden (see specifications) during normal and fault conditions to ensure correct operation. See Section 7.4: CT Specification and Selection on page –230 for information on calculating total burden and CT rating.

For the correct operation of many protective elements, the phase sequence and CT polarity is critical. Ensure that the convention illustrated in FIGURE 3-4: *Typical Wiring for Motor Forward/Reversing Application* on page 3–37 is followed.

### 3.3.5 Ground Current Inputs

The 369 has an isolating transformer with separate 1 A, 5 A, and sensitive HGF (50:0.025) ground terminals. Only one ground terminal type can be used at a time. There are no internal ground connections on the ground current inputs.

The maximum ground CT primary for the 1 A and 5 A taps is 5000 A. Alternatively the sensitive ground input, 50:0.025, can be used to detect ground current on high resistance grounded systems.

The ground CT connection can either be a zero sequence (core balance) installation or a residual connection. Note that only 1 A and 5 A secondary CTs may be used for the residual connection. A typical residual connection is illustrated in below. The zero-sequence connection is shown in the typical wiring diagram. The zero-sequence connection is recommended. Unequal saturation of CTs, CT mismatch, size and location of motor, resistance of the power system, motor core saturation density, etc. may cause false readings in the residually connected ground fault circuit.

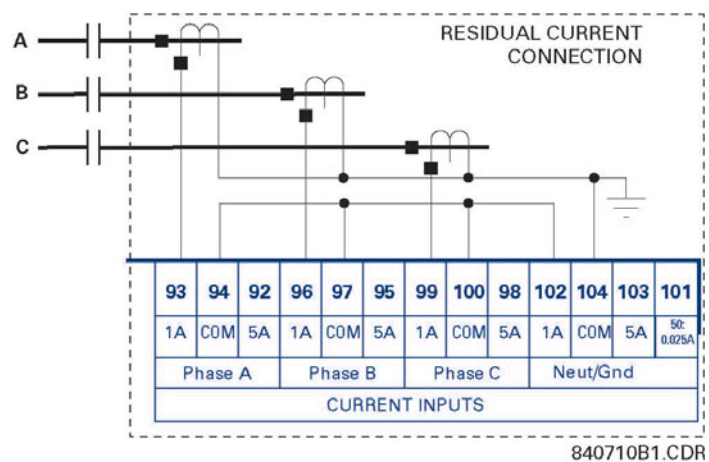

FIGURE 3-5: Typical Residual Connection

### 3.3.6 Zero Sequence Ground CT Placement

The exact placement of a zero sequence CT to properly detect ground fault current is shown below. If the CT is placed over a shielded cable, capacitive coupling of phase current into the cable shield during motor starts may be detected as ground current unless the shield wire is also passed through the CT window. Twisted pair cabling on the zero sequence CT is recommended.

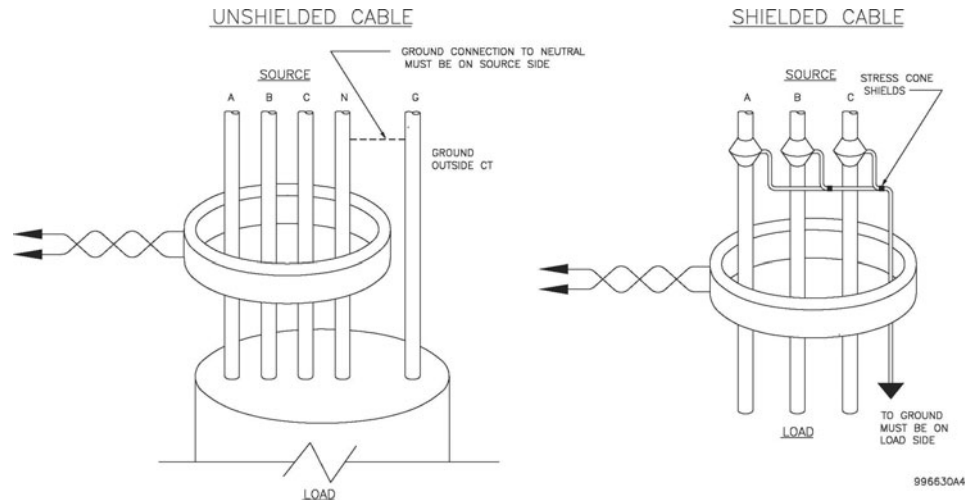

FIGURE 3-6: Zero Sequence CT

### 3.3.7 Phase Voltage (VT/PT) Inputs

The 369 has three channels for AC voltage inputs each with an internal isolating transformer. There are no internal fuses or ground connections on these inputs. The maximum VT ratio is 240:1. These inputs are only enabled when the metering option (M) is ordered.

The 369 accepts either open delta or wye connected VTs (see the figure below). The voltage channels are connected wye internally, which means that the jumper shown on the delta connection between the phase B input and the VT neutral terminals must be installed.

Polarity and phase sequence for the VTs is critical for correct power and rotation measurement and should be verified before starting the motor. As long as the polarity markings on the primary and secondary windings of the VT are aligned, there is no phase



shift. The markings can be aligned on either side of the VT. VTs are typically mounted upstream of the motor breaker or contactor. Typically, a 1 A fuse is used to protect the voltage inputs.

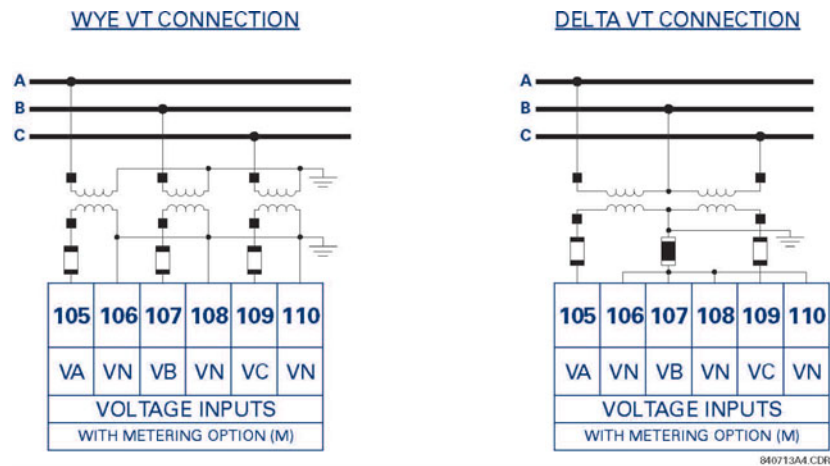

FIGURE 3-7: Wye/Delta Connection

### 3.3.8 Backspin Voltage Inputs

The Backspin voltage input is only operational if the optional backspin detection (B) feature has been purchased for the relay. This input allows the 369 to sense whether the motor is spinning after the primary power has been removed (breaker or contactor opened).

These inputs must be supplied by a separate VT mounted downstream (motor side) of the breaker or contactor. The correct wiring is illustrated below.

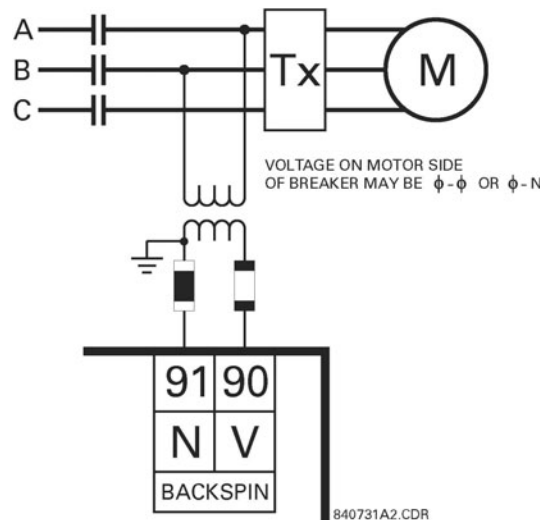

FIGURE 3-8: Backspin Voltage Wiring

### 3.3.9 RTD Inputs

The 369 can monitor up to 12 RTD inputs for Stator, Bearing, Ambient, or Other temperature applications. The type of each RTD is field programmable as: 100 ohm Platinum (DIN 43760), 100 ohm Nickel, 120 ohm Nickel, or 10 ohm Copper. RTDs must be the three wire type. There are no provisions for the connection of thermistors.

The 369 RTD circuitry compensates for lead resistance, provided that each of the three leads is the same length. Lead resistance should not exceed 25 ohms per lead for platinum and nickel type RTDs or 3 ohms per lead for Copper type RTDs.

Shielded cable should be used to prevent noise pickup in industrial environments. RTD cables should be kept close to grounded metal casings and avoid areas of high electromagnetic or radio interference. RTD leads should not be run adjacent to or in the same conduit as high current carrying wires.

The shield connection terminal of the RTD is grounded in the 369 and should not be connected to ground at the motor or anywhere else to prevent noise pickup from circulating currents.

If 10 ohm Copper RTDs are used special care should be taken to keep the lead resistance as low as possible to maintain accurate readings.

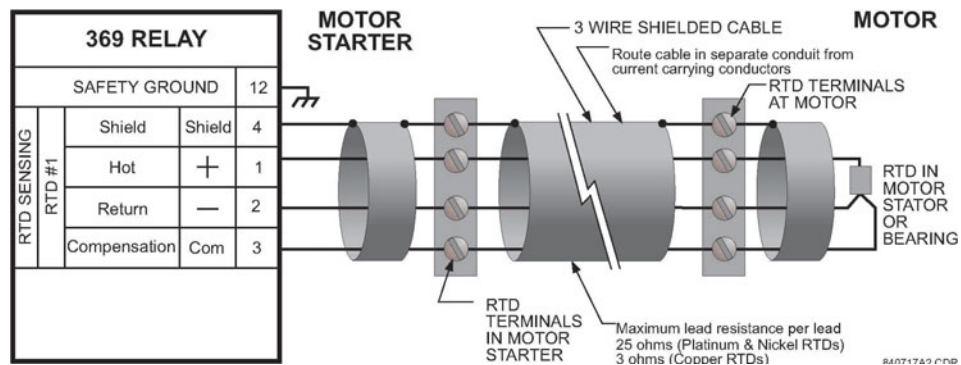

FIGURE 3-9: RTD Inputs

### 3.3.10 Digital Inputs



**DO NOT CONNECT LIVE CIRCUITS TO THE 369 DIGITAL INPUTS. THEY ARE DESIGNED FOR DRY CONTACT CONNECTIONS ONLY.**

Other than the ACCESS switch input the other 5 digital inputs are programmable. These programmable digital inputs have default settings to match the functions of the 269Plus switch inputs (differential, speed, emergency restart, remote reset and spare). However in addition to their default settings they can also be programmed for use as generic inputs to set up trips and alarms or for monitoring purposes based on external contact inputs.



A twisted pair of wires should be used for digital input connections.

### 3.3.11 Analog Outputs

The 369 provides 1 analog current output channel as part of the base unit and 3 additional analog outputs with the metering option (M). These outputs are field programmable to a full-scale range of either 0 to 1 mA (into a maximum 2.4 k $\Omega$  impedance) and 4 to 20 mA or 0 to 20 mA (into a maximum 600  $\Omega$  impedance).

As shown in the typical wiring diagram (FIGURE 3-4: *Typical Wiring for Motor Forward/Reversing Application* on page 3-37), these outputs share one common return. Polarity of these outputs must be observed for proper operation.

Shielded cable should be used for connections, with only one end of the shield grounded, to minimize noise effects. The analog output circuitry is isolated. Transorbs limit this isolation to  $\pm 36$  V with respect to the 369 safety ground.

If an analog voltage output is required, a burden resistor must be connected across the input of the SCADA or measuring device (see the figure below). Ignoring the input impedance of the input,

$$R_{LOAD} = \frac{V_{FULL\ SCALE}}{I_{MAX}} \quad (\text{EQ 3.1})$$

For 0-1 mA, for example, if 5 V full scale is required to correspond to 1 mA

$$R_{LOAD} = \frac{V_{FULL\ SCALE}}{I_{MAX}} = \frac{5\ V}{0.001\ A} = 5000\ \Omega \quad (\text{EQ 3.2})$$

For 4-20 mA, this resistor would be

$$R_{LOAD} = \frac{V_{FULL\ SCALE}}{I_{MAX}} = \frac{5\ V}{0.020\ A} = 250\ \Omega \quad (\text{EQ 3.3})$$

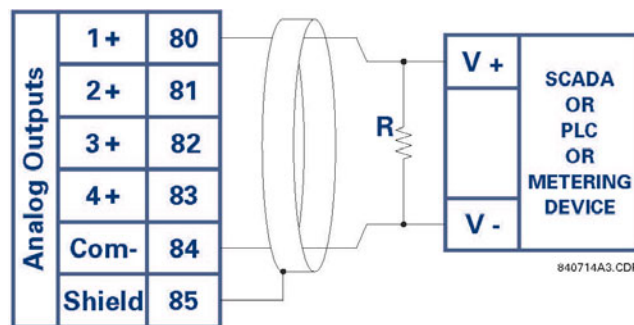

FIGURE 3-10: Analog Output Voltage Connection

### 3.3.12 Remote Display

The 369 display can be separated and mounted remotely up to 15 feet away from the main relay. No separate source of control power is required for the display module. A 15 feet standard shielded network cable is used to make the connection between the display module and the main relay. A recommended and tested cable is available from GE Multilin. The cable should be wired as far away as possible from high current or voltage carrying cables or other sources of electrical noise.

In addition the display module must be grounded if mounted remotely. A ground screw is provided on the back of the display module to facilitate this. A 12 AWG wire is recommended and should be connected to the same ground bus as the main relay unit.

The 369 relay will still function and protect the motor without the display connected.

### 3.3.13 Output Relays

The 369 provides four (4) form C output relays. They are labeled Trip, Aux 1, Aux 2, and Alarm. Each relay has normally open (NO) and normally closed (NC) contacts and can switch up to 8 A at either 250 V AC or 30 V DC with a resistive load. The NO or NC state is determined by the 'no power' state of the relay outputs.

All four output relays may be programmed for fail-safe or non-fail-safe operation. When in fail-safe mode, output relay activation or a loss of control power will cause the contacts to go to their power down state.

#### Example:

- A *fail-safe NO contact* closes when the 369 is powered up (if no prior unreset trip conditions) and will open when activated (tripped) or when the 369 loses control power.
- A *non-fail-safe NO contact* remains open when the 369 is powered up (unless a prior unreset trip condition) and will close only when activated (tripped). If control power is lost while the output relay is activated (NO contacts closed) the NO contacts will open.

Thus, in order to cause a trip on loss of control power to the 369, the Trip relay should be programmed as fail-safe. See the figure below for typical wiring of contactors and breakers for fail-safe and non-fail-safe operation. Output relays remain latched after activation if the fault condition persists or the protection element has been programmed as latched. This means that once this relay has been activated it remains in the active state until the 369 is manually reset.

The Trip relay cannot be reset if a timed lockout is in effect. Lockout time will be adhered to regardless of whether control power is present or not. The relay contacts may be reset if motor conditions allow, by pressing the RESET key, using the REMOTE RESET switch or via communications. The Emergency Restart feature overrides *all* features to reset the 369.

**The rear of the 369 relay shows output relay contacts in their power down state.**



**In locations where system voltage disturbances cause voltage levels to dip below the control power range listed in specifications, any relay contact programmed as fail-safe may change state. Therefore, in any application where the 'process' is more critical**

than the motor, it is recommended that the trip relay contacts be programmed as non-fail-safe. If, however, the motor is more critical than the 'process' then program the trip contacts as fail-safe.

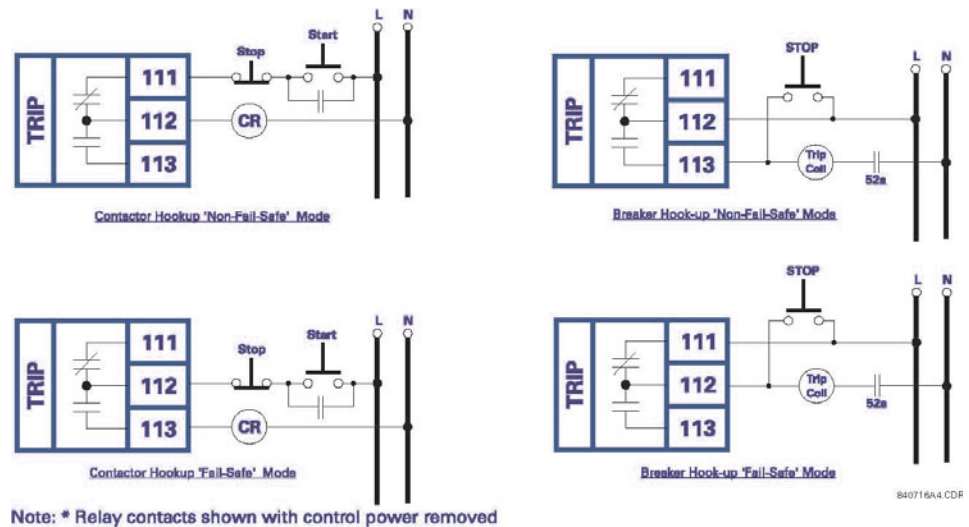

FIGURE 3-11: Hookup / Fail and Non-Failsafe Modes



NOTE

Latched trips and alarms are not retained after control power is removed from the 369

### 3.3.14 RS485 Communications

Three independent two-wire RS485 ports are provided. If option (F), the fiber optic port, is installed and used, the COMM 3 RS485 port may not be used. The RS485 ports are isolated as a group.

Up to 32 369s (or other devices) can be daisy-chained together on a single serial communication channel without exceeding the driver capability. For larger systems, additional serial channels must be added. Commercially available repeaters may also be used to increase the number of relays on a single channel to a maximum of 254. Note that there may only be one master device per serial communication link.

Connections should be made using shielded twisted pair cables (typically 24 AWG). Suitable cables should have a characteristic impedance of 120 ohms (e.g. Belden #9841) and total wire length should not exceed 4000 ft. Commercially available repeaters can be used to extend transmission distances.

Voltage differences between remote ends of the communication link are not uncommon. For this reason, surge protection devices are internally installed across all RS485 terminals. Internally, an isolated power supply with an optocoupled data interface is used to prevent noise coupling. The source computer/PLC/SCADA system should have similar transient protection devices installed, either internally or externally, to ensure maximum reliability.



To ensure that all devices in a daisy-chain are at the same potential, it is imperative that the common terminals of each RS485 port are tied together and grounded in one location only, at the master. Failure to do so may result in intermittent or failed communications.

Correct polarity is also essential. 369 relays must be wired with all '+' terminals connected together, and all '-' terminals connected together. Each relay must be daisy-chained to the next one. Avoid star or stub connected configurations. The last device at each end of the daisy-chain should be terminated with a 120 ohm ¼ watt resistor in series with a 1 nF capacitor across the '+' and '-' terminals. Observing these guidelines will result in a reliable communication system that is immune to system transients.

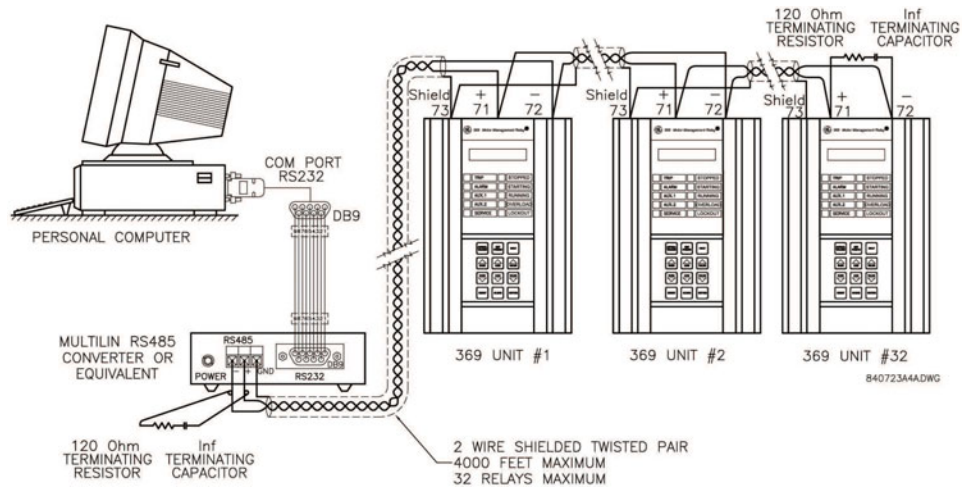
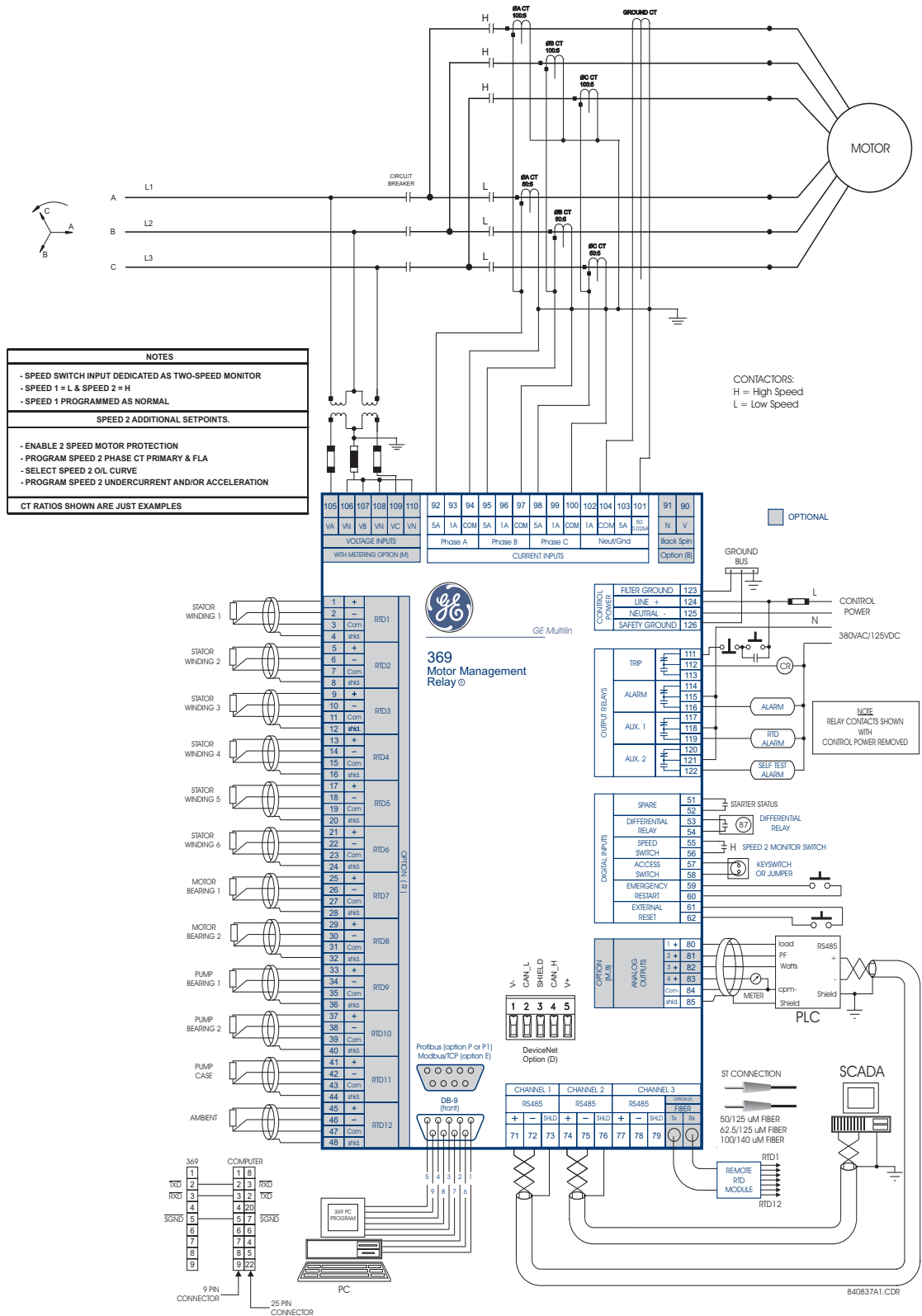

FIGURE 3-12: RS485 Wiring

### 3.3.15 Typical Two-Speed (Low Speed/High Speed) Motor Wiring



The following additional setpoints should be programmed:

**ENABLE 2 SPEED MOTOR PROTECTION** under 5.3.2: *CT/VT Setup*

Program **SPEED2 PHASE CT PRIMARY**, **SPEED2 MOTOR FLA**, and **SPEED 2 SYSTEM PHASE SEQUENCE** under 5.3.2: *CT/VT Setup*.

Select **SPEED2 O/L CURVES** under 5.13: *S12 Two-speed Motor*.

Program **SPEED2 UNDERCURRENT** and **SPEED2 ACCELERATION** under 5.13: *S12 Two-speed Motor*.



1. Speed switch input dedicated as Two-speed monitor.
2. Speed 1 = L (Low) ; Speed 2 = H (High).
3. Speed 1 programmed as normal.



### 3.3.16 Typical Motor Forward/Reverse Wiring

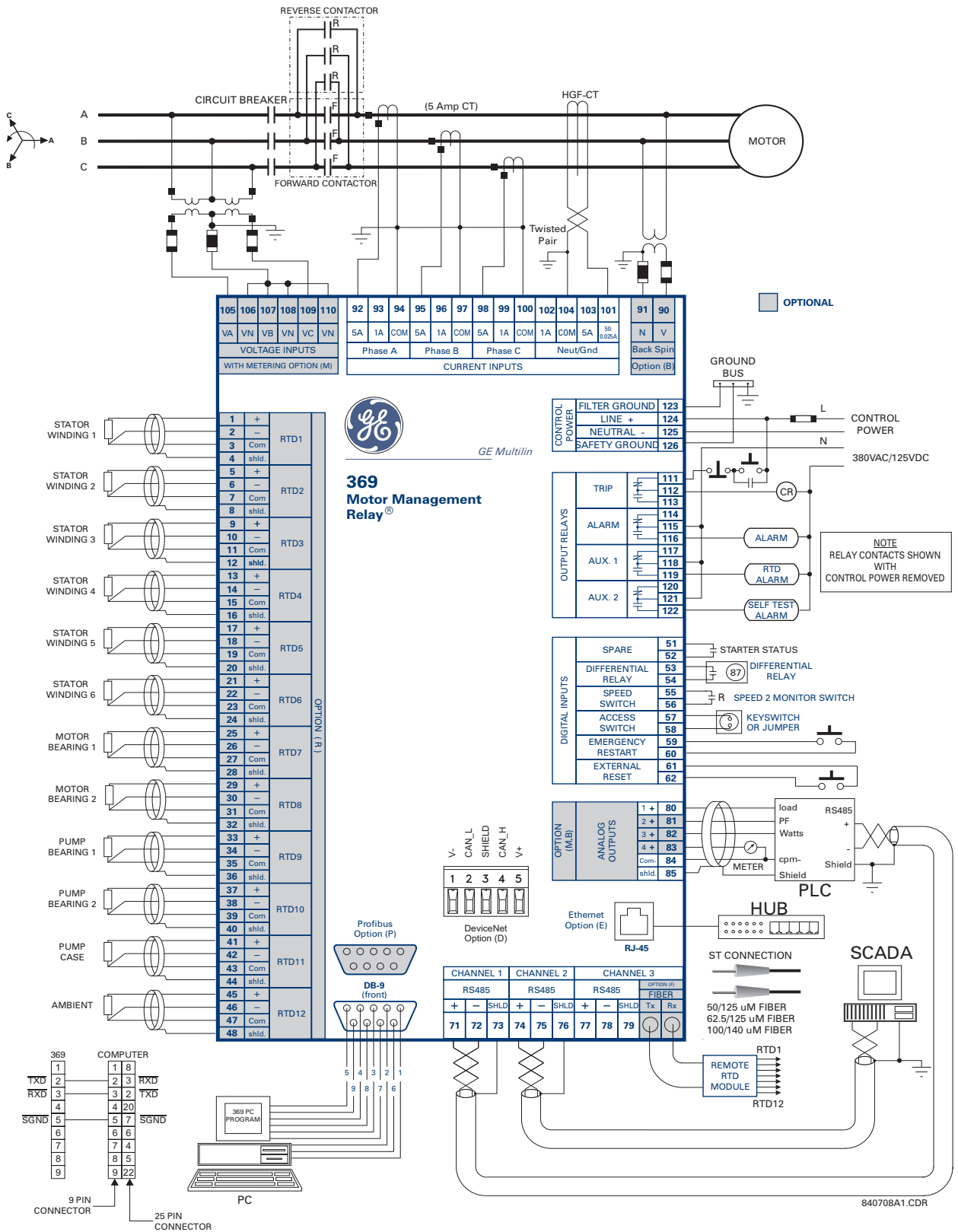

The following additional setpoints should be programmed:

Enable **2-SPEED MOTOR PROTECTION** under 5.3.2: *CT/VT Setup*.

Program **SPEED2 PHASE CT PRIMARY**, **SPEED2 MOTOR FLA**, and **SPEED2 SYSTEM PHASE SEQUENCE** under 5.3.2: *CT/VT Setup*.

Select **SPEED2 O/L CURVES** under 5.13: *S12 Two-speed Motor*.

Program **SPEED2 UNDERCURRENT** and **SPEED2 ACCELERATION** under 5.13: *S12 Two-speed Motor*.



1. VT must be connected on the breaker side of the contactor for proper power metering and phase reversal trip protection.
2. The system phase sequence of the VT input to the 369 must be the same as the system phase sequence setpoint and the phase sequence for forward rotation of the motor.
3. The phase sequence for the reverse direction must be set as the Speed 2 phase sequence.
4. Speed switch input dedicated as the Two-Speed monitor.
5. Speed 1 = F (Forward); Speed 2 = R (Reverse).
6. Speed 1 programmed as normal.

## 3.4 Remote RTD Module (RRTD)

### 3.4.1 Mechanical Installation

The optional remote RTD module is designed to be mounted near the motor. This eliminates the need for multiple RTD cables to run back from the motor which may be in a remote location to the switchgear. Although the module is internally shielded to minimize noise pickup and interference, it should be mounted away from high current conductors or sources of strong magnetic fields.

The remote RTD module physical dimensions and mounting (drill diagram) are shown below. Mounting hardware (bolts and washers) and instructions are provided with the module.

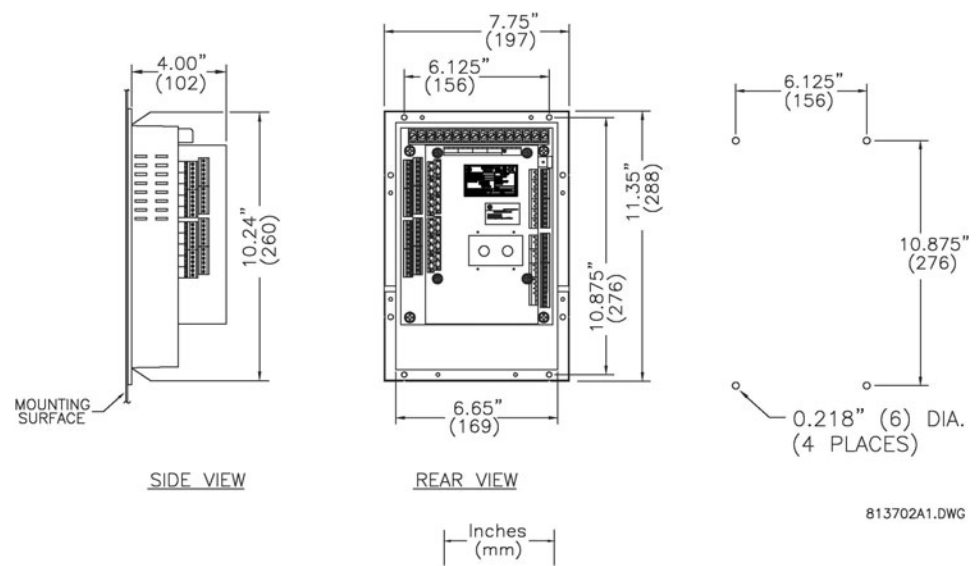

FIGURE 3–13: Remote RTD Dimensions

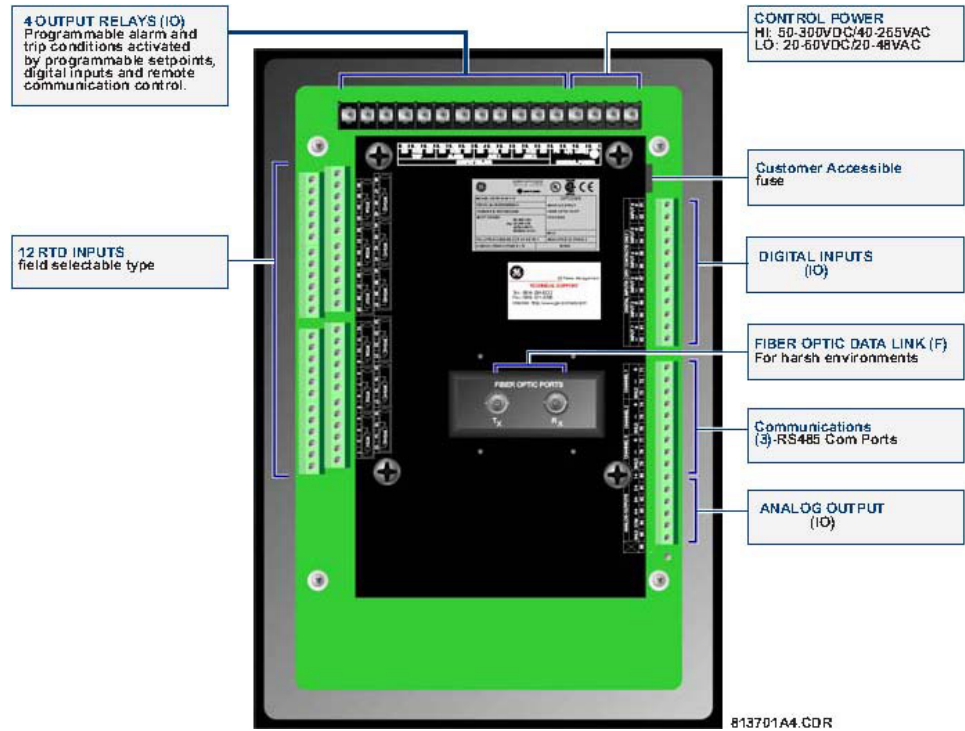

FIGURE 3-14: Remote RTD Rear View

### 3.4.2 Electrical Installation

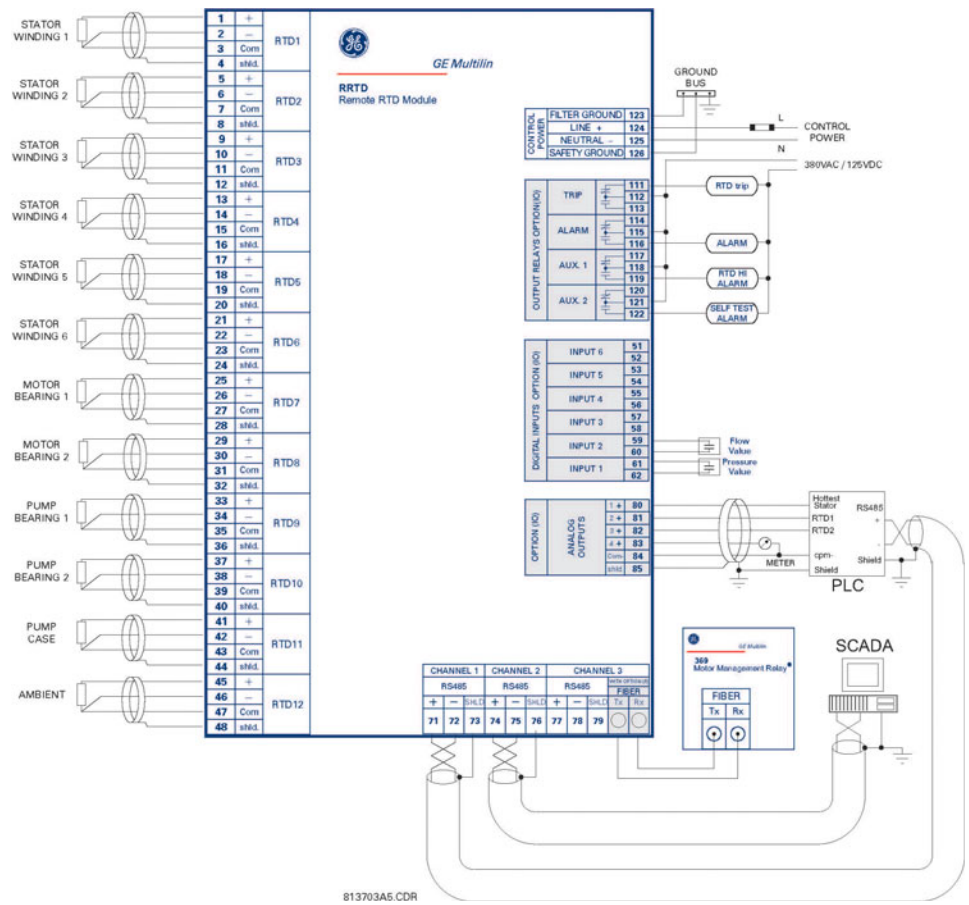

FIGURE 3–15: Remote RTD Module

### 3.5 CT Installation

#### 3.5.1 Phase CT Installation

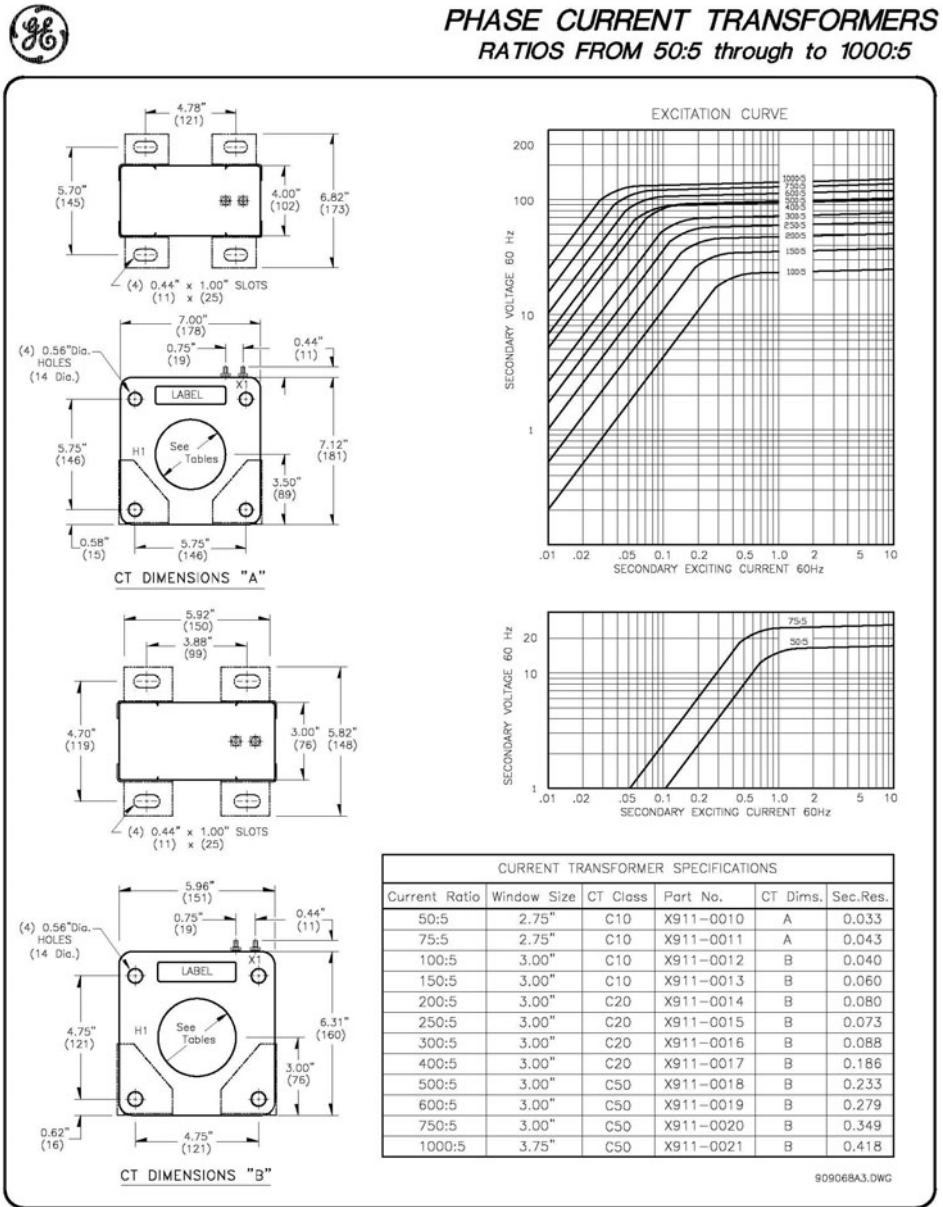
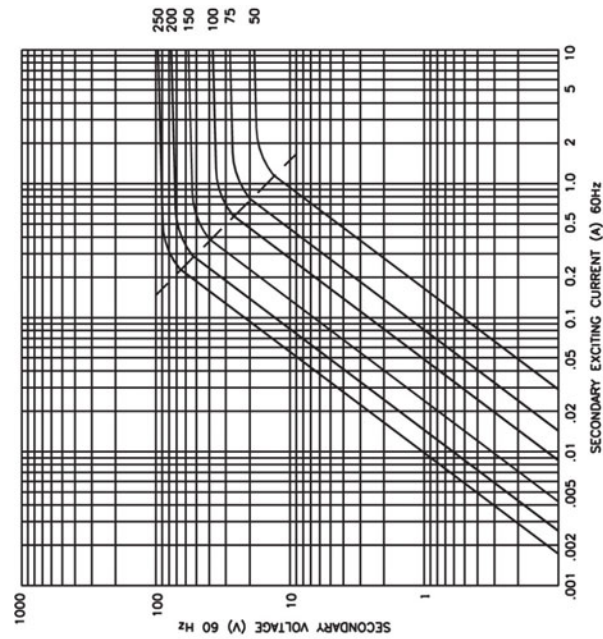
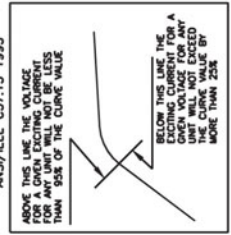

FIGURE 3-16: Phase CT Installation

3.5.2 5 Amp Ground CT Installation



This test report is in accordance with ANSI/IEEE C57.13 1993



GE PM PART NO.	CURRENT RATIO	TURNS RATIO	SEC RES.*
X912-0013	250:5	50:1	0.097
X912-0011	200:5	40:1	0.078
X912-0009	150:5	30:1	0.058
X912-0007	100:5	20:1	0.039
X912-0005	75:5	15:1	0.029
X912-0003	50:5	10:1	0.019

\* OHMS AT 75° C.

909005A7.DWG

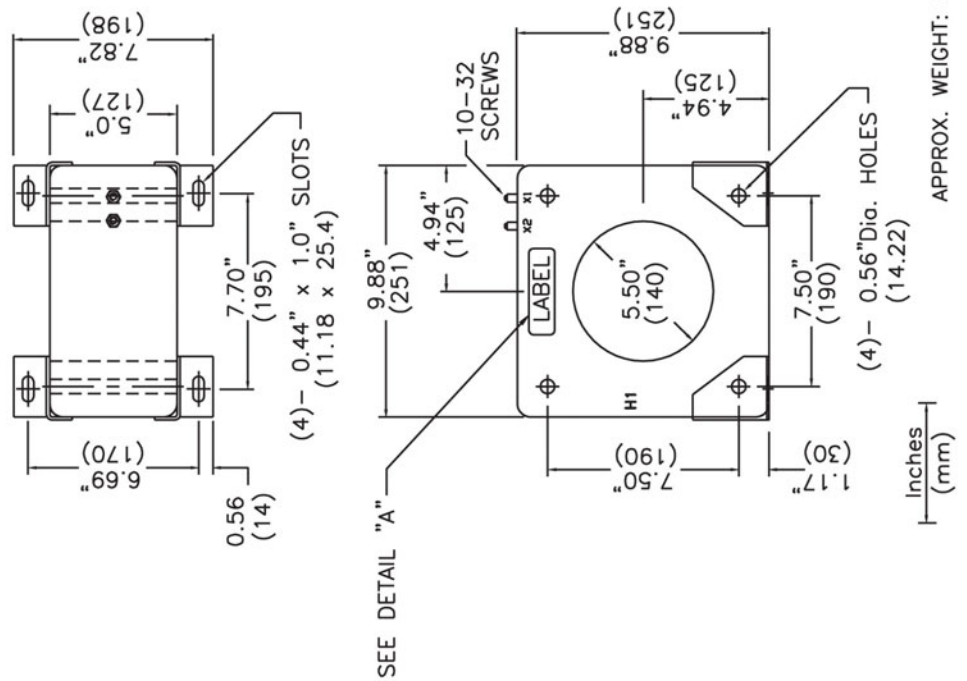
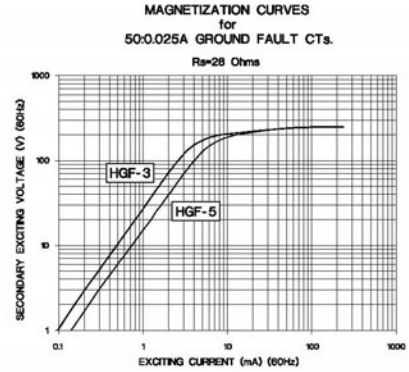
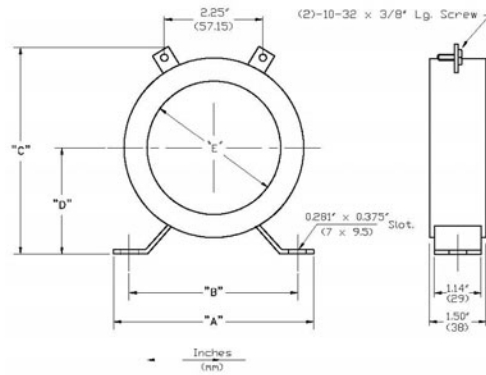

FIGURE 3-17: 5 A Ground CT Installation

3.5.3 HGF (50:0.025) Ground CT Installation



PART NO.	DIMENSIONS															
	A		B			C			D		E					
	Min.	Nom.	Min.	Max.	Min.	Max.	Min.	Max.	Min.	Max.	Min.	Max.				
CT-HGF5	7.80	198	7.00	179	8.40	213	8.50	216	8.60	218	4.50	114	5.50	145	5.90	150
CT-HGF3	6.00	152	5.25	133	5.65	144	5.75	146	5.85	149	2.90	74	3.50	89	3.70	94

9092598.DWG

FIGURE 3-18: HGF (50:0.025) Ground CT Installation, 3" and 5" Window

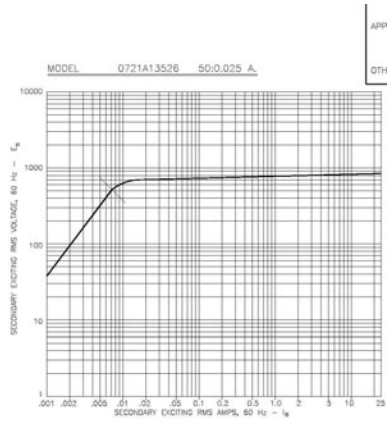
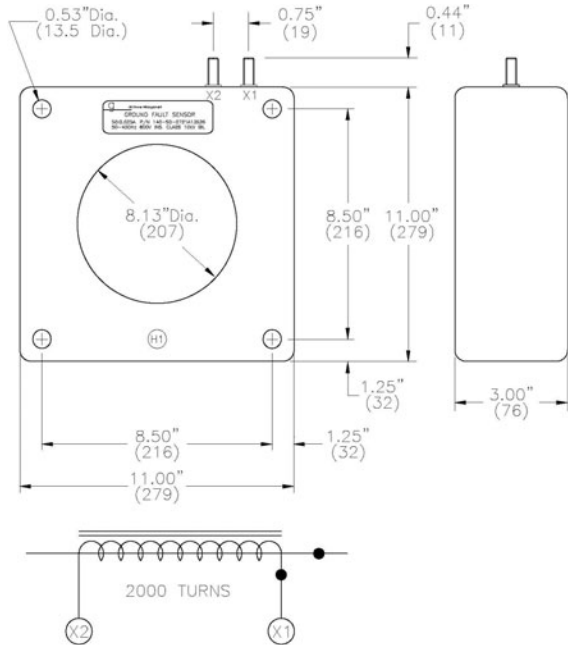

CURRENT RATIO	TURNS RATIO	SEC. RES. *
50:0.025	2000:1	24.85

\* OHMS AT 75° C.

NOTE: THIS LINE USES THE VOLTAGE FOR A GIVEN EXCITING CURRENT. THE LINE SHOULD BE USED FOR THE OHMS VALUE AT 75° C.

910182A5.DWG

FIGURE 3-19: HGF (50:0.025) Ground CT Installation, 8" Window





# 369 Motor Management Relay

## Chapter 4: User Interfaces

---

### 4.1 Faceplate Interface

#### 4.1.1 Display

All messages are displayed on a 40-character LCD display to make them visible under poor lighting conditions and from various viewing angles. Messages are displayed in plain English and do not require the aid of an instruction manual for deciphering. While the keypad and display are not actively being used, the display will default to user defined status messages. Any trip, alarm, or start inhibit will automatically override the default messages and appear on the display.

#### 4.1.2 LED Indicators

There are ten LED indicators, as follows:

- **TRIP:** Trip relay has operated (energized)
- **ALARM:** Alarm relay has operated (energized)
- **AUX 1:** Auxiliary relay has operated (energized)
- **AUX 2:** Auxiliary relay has operated (energized)
- **SERVICE:** Relay in need of technical service.
- **STOPPED:** Motor is in the Stopped condition
- **STARTING:** Motor is in the Starting condition
- **RUNNING:** Motor is in the Running condition
- **OVERLOAD:** Motor is in the Overload condition
- **LOCKOUT:** Motor is in the Lockout condition

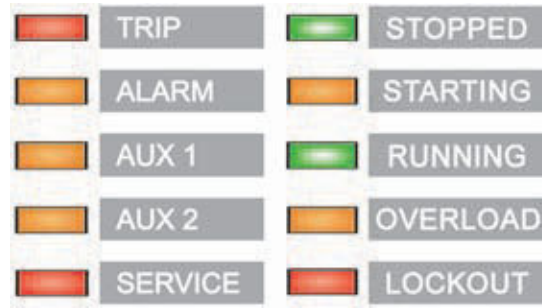

FIGURE 4-1: LED Indicators - Enhanced Faceplate

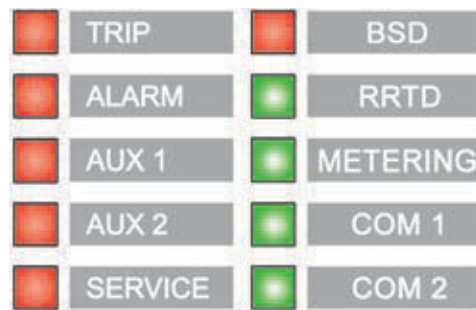

FIGURE 4-2: LED Indicators - Basic Faceplate

### 4.1.3 RS232 Program Port

This port is intended for connection to a portable PC. Setpoint files may be created at any location and downloaded through this port using the EnerVista 369 Setup software. Local interrogation of Setpoints and Actual Values is also possible. New firmware may be downloaded to the 369 Relay flash memory through this port. Upgrading of the relay firmware does not require a hardware EPROM change.

### 4.1.4 Keypad

The 369 Relay messages are organized into pages under the main headings, Setpoints and Actual Values. The [SETPOINTS] key is used to navigate through the page headers of the programmable parameters. The [ACTUAL VALUES] key is used to navigate through the page headers of the measured parameters.

Each page is broken down further into logical subgroups of messages. The [PAGE] up and down keys may be used to navigate through the subgroups.

- [SETPOINTS]: This key may be used to navigate through the page headers of the programmable parameters. Alternately, one can press this key followed by using the Page Up / Page Down keys.
- [ACTUAL VALUES]: This key is used to navigate through the page headers of the measured parameters. Alternately, one can scroll through the pages by pressing the Actual Values key followed by using the Page Up / Page Down keys.

- [PAGE]: The Page Up/ Page Down keys may be used to scroll through page headers for both Setpoints and Actual Values.
- [LINE]: Once the required page is found, the Line Up/ Line Down keys may be used to scroll through the sub-headings.
- [VALUE]: The Value Up and Value Down keys are used to scroll through variables in the Setpoint programming mode. It will increment and decrement numerical Setpoint values, or alter yes/no options.
- [RESET]: The reset key may be used to reset a trip or latched alarm, provided it has been activated by selecting the local reset.
- [ENTER] The key is dual purpose. It is used to enter the subgroups or store altered setpoint values.
- [CLEAR] The key is also dual purpose. It may be used to exit the subgroups or to return an altered setpoint to its original value before it has been stored.
- [HELP]: The help key may be pressed at any time for context sensitive help messages; such as the Setpoint range, etc.

To enter setpoints, select the desired page header. Then press the [LINE UP] / [LINE DOWN] keys to scroll through the page and find the desired subgroup. Once the desired subgroup is found, press the [VALUE UP] / [VALUE DOWN] keys to adjust the setpoints. Press the [ENTER] key to save the setpoint or the [CLEAR] key to revert back to the old setpoint.

#### 4.1.5 Setpoint Entry

In order to store any setpoints, Terminals 57 and 58 (access terminals) must be shorted (a key switch may be used for security). There is also a Setpoint Passcode feature that may be enabled to restrict access to setpoints. The passcode must be entered to allow the changing of setpoint values. A passcode of 0 effectively turns off the passcode feature and only the access jumper is required for changing setpoints.

If no key is pressed for 30 minutes, access to setpoint values will be restricted until the passcode is entered again. To prevent setpoint access before the 30 minutes expires, the unit may be turned off and back on, the access jumper may be removed, or the **SETPOINT ACCESS** setpoint may be changed to **Restricted**. The passcode cannot be entered until terminals 57 and 58 (access terminals) are shorted.

Setpoint changes take effect immediately, even when motor is running. It is not recommended, however, to change setpoints while the motor is running as any mistake could cause a nuisance trip.

Refer to Section 5.2.1: Setpoint Access on page –111 for a detailed description of the setpoint access procedure.

## 4.2 EnerVista 369 Setup Interface

### 4.2.1 Hardware and Software Requirements

The following minimum requirements must be met for the EnerVista 369 Setup software to operate on your computer.

- Pentium class or higher processor (Pentium II 300 MHz or better recommended)
- Microsoft Windows 95, 98, 98SE, ME, NT 4.0 (SP4 or higher), 2000, XP
- 64 MB of RAM (256 MB recommended)
- Minimum of 50 MB hard disk space (200 MB recommended)

If EnerVista 369 Setup is currently installed, note the path and directory name. It may be required during upgrading.

The EnerVista 369 Setup software is included on the GE enerVista CD that accompanied the 369 Relay. The software may also be downloaded from the GE Multilin website at <http://www.GEindustrial.com/multilin>.

### 4.2.2 Installing EnerVista 369 Setup

After ensuring these minimum requirements, use the following procedure to install the EnerVista 369 Setup software from the enclosed GE enerVista CD.

- ▷ Insert the GE enerVista CD into your CD-ROM drive.
- ▷ Click the **Install Now** button and follow the installation instructions to install the no-charge enerVista software on the local PC.
- ▷ When installation is complete, start the enerVista Launchpad application.
- ▷ Click the **IED Setup** section of the **Launch Pad** window.



- ▷ In the enerVista LaunchPad window, click the **Add Product** button and select the “369 Motor Management Relay” as shown below. Select the “Web” option to ensure the most recent software release, or select “CD” if you do not have a web connection, then click the **Add Now** button to list software items for the 369 Relay.

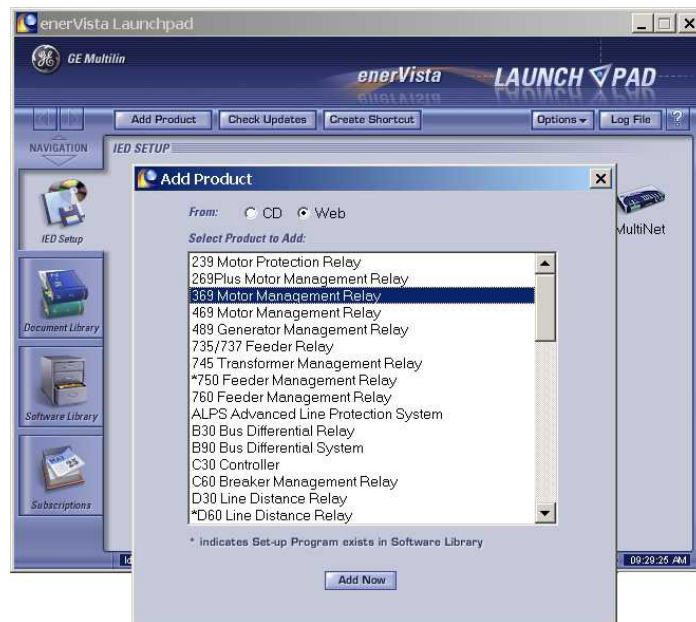

EnerVista Launchpad will obtain the installation program from the Web or CD.

- ▷ Once the download is complete, double-click the installation program to install the EnerVista 369 Setup software.

The program will request the user to create a backup 3.5" floppy-disk set.

- ▷ If this is desired, click on the **Start Copying** button; otherwise, click on the **CONTINUE WITH 369 Relay INSTALLATION** button.
- ▷ Select the complete path, including the new directory name, where the EnerVista 369 Setup software will be installed.
- ▷ Click on **Next** to begin the installation.  
The files will be installed in the directory indicated and the installation program will automatically create icons and add EnerVista 369 Setup software to the Windows start menu.

- ▶ Click **Finish** to end the installation.  
The 369 Relay device will be added to the list of installed IEDs in the enerVista Launchpad window, as shown below.



---

## 4.3 Connecting EnerVista 369 Setup to the Relay

### 4.3.1 Configuring Serial Communications

Before starting, verify that the serial cable is properly connected to either the RS232 port on the front panel of the device (for RS232 communications) or to the RS485 terminals on the back of the device (for RS485 communications).

This example demonstrates an RS232 connection. For RS485 communications, the GE Multilin F485 converter will be required. Refer to the F485 manual for additional details. To configure the relay for Ethernet communications, see *Configuring Ethernet Communications* on page 4–65.

- ▷ Install and start the latest version of the EnerVista 369 Setup software (available from the GE enerVista CD). See the previous section for the installation procedure.
- ▷ Click on the **Device Setup** button to open the Device Setup window.
- ▷ Click the **Add Site** button to define a new site.
- ▷ Enter the desired site name in the **Site Name** field. If desired, a short description of site can also be entered along with the display order of devices defined for the site. In this example, we will use “Substation 1” as the site name.
- ▷ Click the **OK** button when complete.

The new site will appear in the upper-left list in the EnerVista 369 Setup window.

- ▷ Click the **Add Device** button to define the new device.
- ▷ Enter the desired name in the **Device Name** field and a description (optional) of the site.
- ▷ Select “Serial” from the Interface drop-down list. This will display a number of interface parameters that must be entered for proper RS232 functionality.

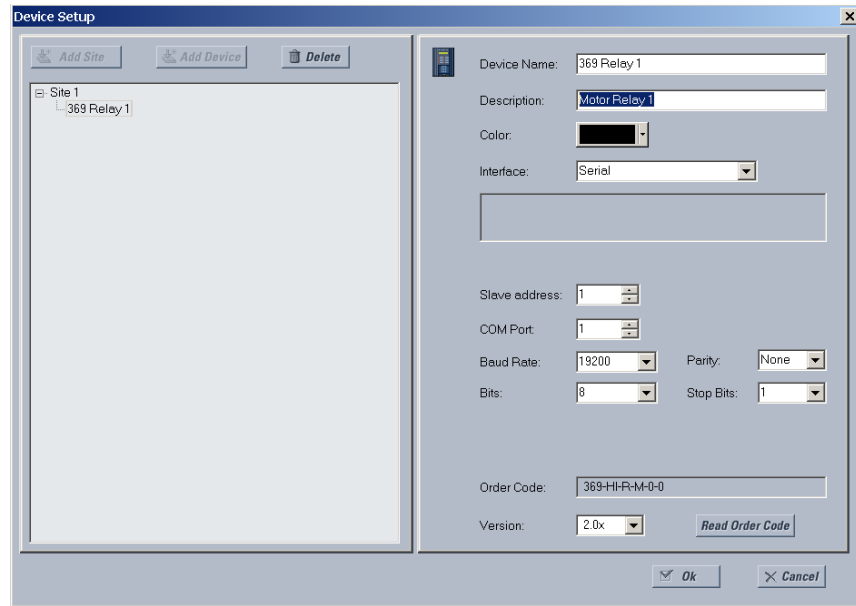

- ▷ Enter the slave address and COM port values (from the **S1 369 RELAY SETUP** ⇒ **369 RELAY COMMUNICATIONS** menu) in the Slave Address and COM Port fields.
- ▷ Enter the physical communications parameters (baud rate and parity settings) in their respective fields.
- ▷ Click the **Read Order Code** button to connect to the 369 Relay device and upload the order code.  
If an communications error occurs, ensure that the 369 Relay serial communications values entered in the previous step correspond to the relay setting values.
- ▷ Click **OK** when the relay order code has been received.  
The new device will be added to the Site List window (or Online window) located in the top left corner of the main EnerVista 369 Setup window.

The 369 Relay Site Device has now been configured for serial communications. Proceed to *Connecting to the Relay* on page 4-67 to begin communications.



### 4.3.2 Using the Quick Connect Feature

The Quick Connect button can be used to establish a fast connection through the front panel RS232 port of a 369 Relay relay. The following window will appear when the Quick Connect button is pressed:

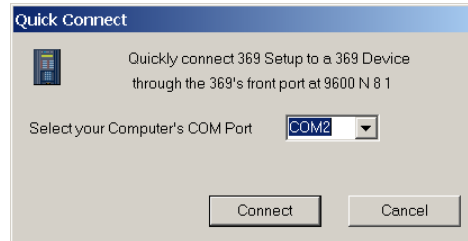

As indicated by the window, the Quick Connect feature quickly connects the EnerVista 369 Setup software to a 369 Relay front port with the following settings: 9600 baud, no parity, 8 bits, 1 stop bit. Select the PC communications port connected to the relay and press the **Connect** button.

The EnerVista 369 Setup software will display a window indicating the status of communications with the relay. When connected, a new Site called “Quick Connect” will appear in the Site List window. *The properties of this new site cannot be changed.*

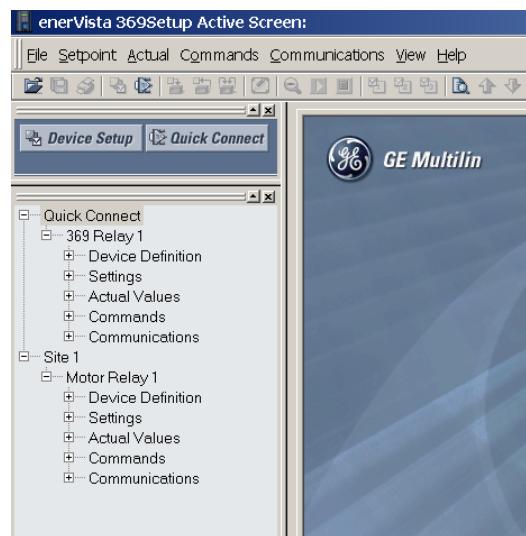

The 369 Relay Site Device has now been configured via the Quick Connect feature for serial communications. Proceed to *Connecting to the Relay* on page 4–67 to begin communications.

### 4.3.3 Configuring Ethernet Communications

Before starting, verify that the Ethernet cable is properly connected to the MultiNET device, and that the MultiNET has been configured and properly connected to the relay. Refer to the MultiNET manual for additional details on configuring the MultiNET to work with the 369 Relay.

- ▷ Install and start the latest version of the EnerVista 369 Setup software (available from the GE enerVista CD). See the previous section for the installation procedure.
- ▷ Click on the **Device Setup** button to open the Device Setup window.
- ▷ Click the **Add Site** button to define a new site.
- ▷ Enter the desired site name in the **Site Name** field.  
If desired, a short description of site can also be entered along with the display order of devices defined for the site. In this example, we will use “Substation 2” as the site name.
- ▷ Click the **OK** button when complete.

The new site will appear in the upper-left list in the EnerVista 369 Setup window.

- ▷ Click the **Add Device** button to define the new device.
- ▷ Enter the desired name in the **Device Name** field and a description (optional) of the site.
- ▷ Select **Ethernet** from the Interface drop-down list.  
This will display a number of interface parameters that must be entered for proper Ethernet functionality.

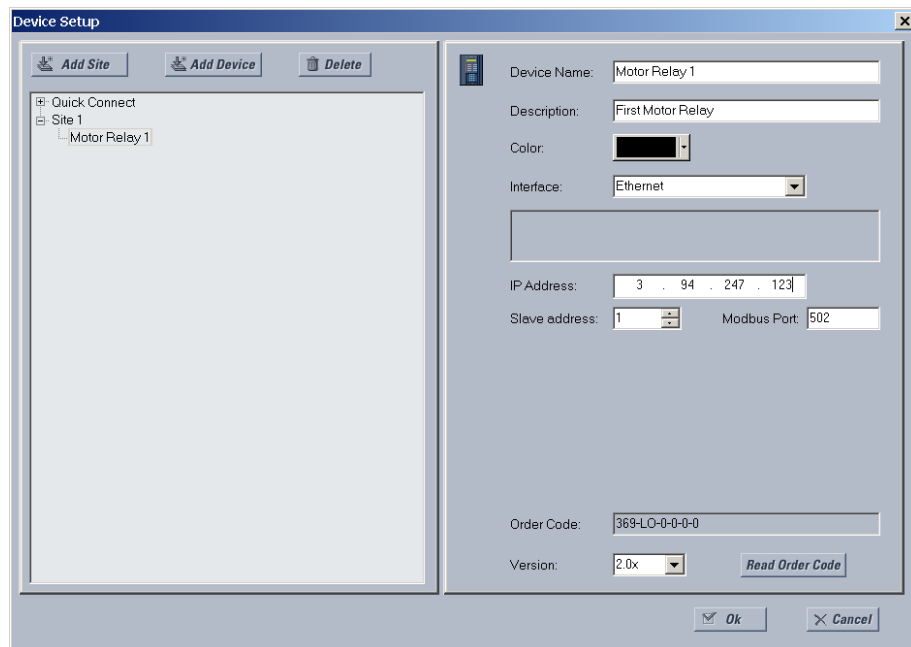

- ▷ Enter the IP address assigned to the MultiNET adapter.
- ▷ Enter the slave address and Modbus port values (from the **S1 369 RELAY SETUP** ⇒ **369 RELAY COMMUNICATIONS** menu) in the Slave Address and Modbus Port fields.

- ▷ Click the **Read Order Code** button to connect to the 369 Relay device and upload the order code.  
If an communications error occurs, ensure that the 369 Relay Ethernet communications values entered in the previous step correspond to the relay and MultiNET setting values.
- ▷ Click **OK** when the relay order code has been received.  
The new device will be added to the Site List window (or Online window) located in the top left corner of the main EnerVista 369 Setup window.

The 369 Relay Site Device has now been configured for Ethernet communications. Proceed to the following section to begin communications.

#### 4.3.4 Connecting to the Relay

Now that the communications parameters have been properly configured, the user can easily connect to the relay.

- ▷ Expand the Site list by double clicking on the site name or clicking on the «+» box to list the available devices for the given site (for example, in the “Substation 1” site shown below).
- ▷ Desired device trees can be expanded by clicking the «+» box. The following list of headers is shown for each device:
  - Device Definitions
  - Settings
  - Actual Values
  - Commands
  - Communications

- ▷ Expand the Settings > Relay Setup list item and double click on Front Panel to open the Front Panel settings window as shown below:

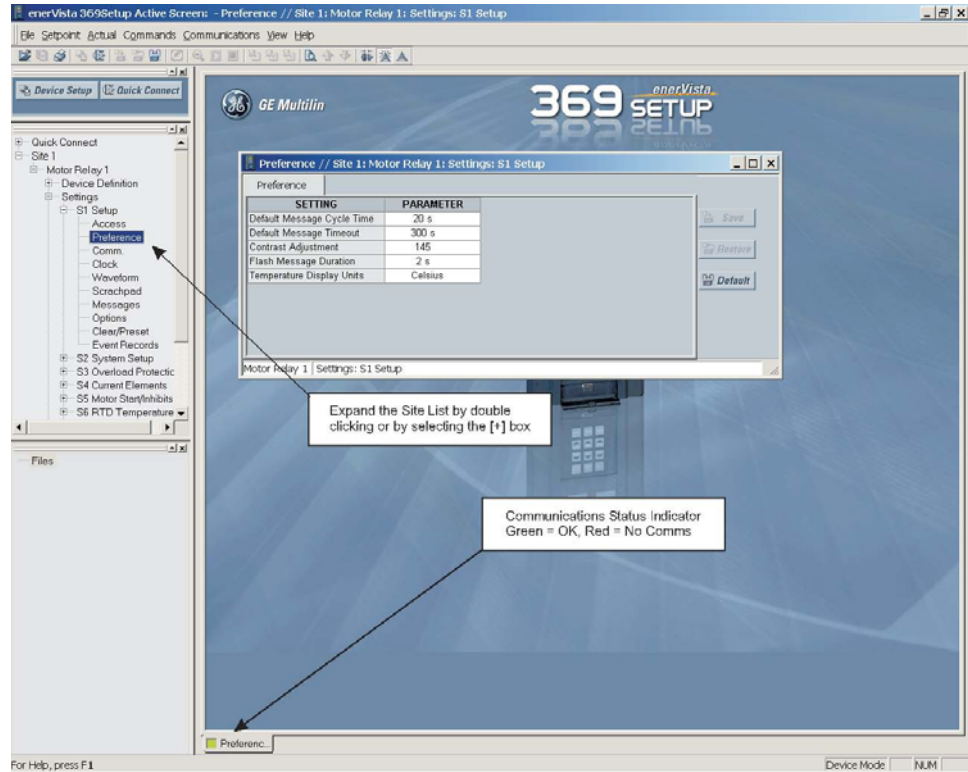

FIGURE 4-3: Main Window After Connection

The Front Panel settings window will open with a corresponding status indicator on the lower left of the EnerVista 369 Setup window.

- ▷ If the status indicator is red, verify that the serial or Ethernet cable is properly connected to the relay, and that the relay has been properly configured for communications (steps described earlier).

The Front Panel settings can now be edited, printed, or changed according to user specifications. Other setpoint and commands windows can be displayed and edited in a similar manner. Actual values windows are also available for display. These windows can be locked, arranged, and resized at will.



**Refer to the EnerVista 369 Setup Help File for additional information about the using the software.**

## 4.4 Working with Setpoints and Setpoint Files

### 4.4.1 Engaging a Device

The EnerVista 369 Setup software may be used in on-line mode (relay connected) to directly communicate with a 369 Relay relay. Communicating relays are organized and grouped by communication interfaces and into sites. Sites may contain any number of relays selected from the SR or UR product series.

### 4.4.2 Entering Setpoints

The System Setup page will be used as an example to illustrate the entering of setpoints. In this example, we will be changing the current sensing setpoints.

- ▷ Establish communications with the relay.
- ▷ Select the **Setpoint > S2 System Setup > CT/VT Setup** menu item. This can be selected from the device setpoint tree or the main window menu bar.
- ▷ Select the **PHASE CT PRIMARY** setpoint by clicking anywhere in the parameter box. This will display three arrows: two to increment/decrement the value and another to launch the numerical calculator.

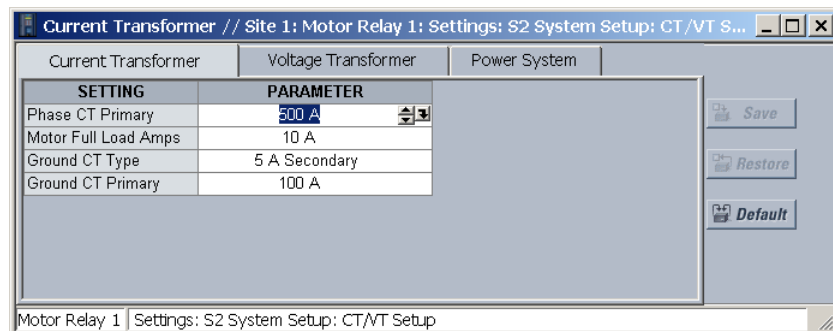

- ▶ Clicking the arrow at the end of the box displays a numerical keypad interface that allows the user to enter a value within the setpoint range displayed near the top of the keypad:

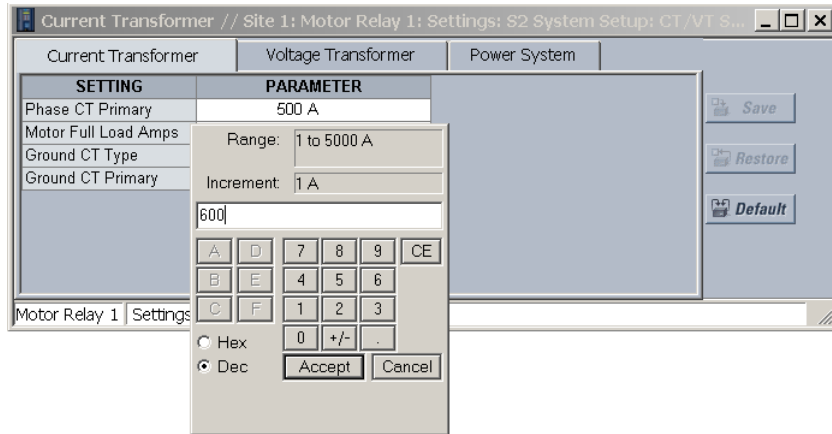

- ▶ Click **Accept** to exit from the keypad and keep the new value.
- ▶ Click on **Cancel** to exit from the keypad and retain the old value.
- ▶ For setpoints requiring non-numerical pre-set values (e.g. **GROUND CT TYPE** above), clicking anywhere within the setpoint value box displays a drop-down selection menu arrow. Select the desired value from this list.

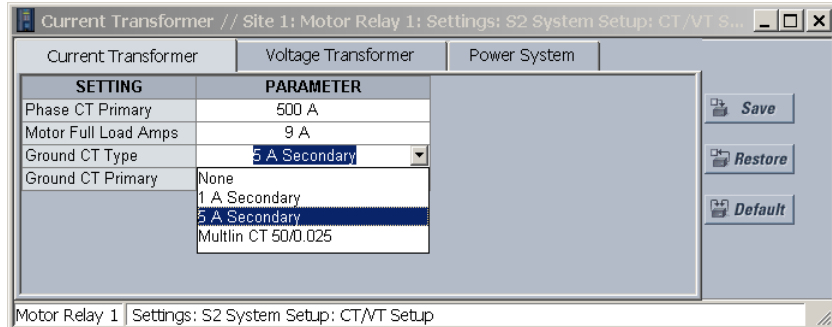

- ▶ For setpoints requiring an alphanumeric text string (e.g. message scratchpad messages), the value may be entered directly within the setpoint value box.
- ▶ Click on **Save** to save the values into the 369 Relay.
- ▶ Click **OK** to accept any changes and exit the window.
- ▶ Otherwise, click **Restore** to retain previous values and exit.

### 4.4.3 File Support

Opening any EnerVista 369 Setup file will automatically launch the application or provide focus to the already opened application. If the file is a settings file (has a '369 Relay' extension) which had been removed from the Settings List tree menu, it will be added back to the Settings List tree.

New files will be automatically added to the tree, which is sorted alphabetically with respect to settings file names.

### 4.4.4 Using Setpoints Files

#### Overview

The EnerVista 369 Setup software interface supports three ways of handling changes to relay settings:

- In *off-line* mode (relay disconnected) to create or edit relay settings files for later download to communicating relays.
- Directly modifying relay settings while *connected* to a communicating relay, then saving the settings when complete.
- Creating/editing settings files while *connected* to a communicating relay, then saving them to the relay when complete.

Settings files are organized on the basis of file names assigned by the user. A settings file contains data pertaining to the following categories of relay settings:

- Device Definition
- Product Setup
- System Setup
- Grouped Elements
- Control Elements
- Inputs/Outputs
- Testing

Factory default values are supplied and can be restored after any changes.

The EnerVista 369 Setup software displays relay setpoints with the same hierarchy as the front panel display. For specific details on setpoints, refer to Chapter 5.

#### Downloading and Saving Setpoints Files

Setpoints must be saved to a file on the local PC before performing any firmware upgrades. Saving setpoints is also highly recommended before making any setpoint changes or creating new setpoint files.

The EnerVista 369 Setup window, setpoint files are accessed in the Settings List control bar window or the Files Window. Use the following procedure to download and save setpoint files to a local PC.

- ▷ Ensure that the site and corresponding device(s) have been properly defined and configured as shown in *Connecting EnerVista 369 Setup to the Relay* on page 4–63.

- ▷ Select the desired device from the site list.
- ▷ Select the **File > Read Settings from Device** menu item to obtain settings information from the device.

After a few seconds of data retrieval, the software will request the name and destination path of the setpoint file. The corresponding file extension will be automatically assigned.

- ▷ Press **Save** to complete the process.  
A new entry will be added to the tree, in the File pane, showing path and file name for the setpoint file.

### Adding Setpoints Files to the Environment

The EnerVista 369 Setup software provides the capability to review and manage a large group of setpoint files. Use the following procedure to add a new or existing file to the list.

- ▷ In the files pane, right-click on 'Files'.
- ▷ Select the **Add Existing Setting File** item as shown

:

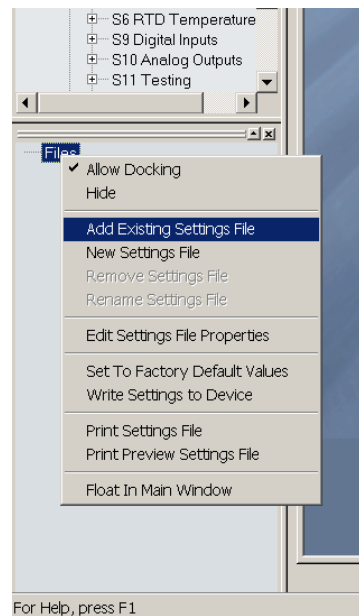

The Open dialog box will appear, prompting the user to select a previously saved setpoint file.

- ▷ As for any other Microsoft Windows® application, browse for the file to be added then
- ▷ Click **Open**.  
The new file and complete path will be added to the file list.



## Creating a New Settings File using Motor Settings Auto-Config

The EnerVista 369 Setup software allows the user to create new Settings files independent of a connected device. These can be uploaded to a relay at a later date.

One method of doing this - the **EnerVista Motor Settings Auto-Config** option - allows the user to easily create new Settings Files automatically, using a guided step-by-step process as outlined below.



The Motor Settings Auto-Config option does NOT allow the user to configure existing Settings Files.

The following procedure illustrates how to create new Settings Files using the Motor Settings Auto-Config option:

- ▶ At the top of the screen, click on the **Motor Settings Auto-Config** button.



OR

- ▶ On the main menu, select **File > Motor Settings Auto-Configurator**

The EnerVista 369 Setup software displays the following box, allowing the configuration of the Settings File as shown.



It is important to define the correct firmware version to ensure that settings not available in a particular version are not downloaded into the relay

- ▷ Select the Firmware **Version** for the new Settings File.
- ▷ For future reference, enter some useful information in the **Description** box to facilitate the identification of the device and the purpose of the file.
- ▷ To select a file name and path for the new file, click the button [...] beside the **File Name** box.
- ▷ Select the file name and path to store the file, or select any displayed file name to update an existing file.  
All 369 Relay Settings Files should have the extension '369 Relay' (for example, 'motor1.369 Relay').

- ▷ Click **Next** and **OK** to continue the process.  
A new window - **Step 1** - will appear:

**Motor Settings Auto-Config**

STEP  
1 2 3 4 5 6

**1 Motor Nameplate**

File Name: D:\Documents and Settings\All Users\Docur  
 Order Code: 369-HI-R-M-F-0-0-0  
 Version: 3.0x

Full Load Amps: 229 A  
 Locked Rotor Amps: 1260 A  550 % of FLA  
 Rated Voltage: 6000 V  
 Service Factor:  1.0  1.15  
 Safe Stall Time: HOT 18 COLD 24

*Parameters marked with "○" are required fields*

← Back   **Next** →   × Cancel

- ▷ Fill in the fields as indicated.
- ▷ When complete, **press** Next.  
The next window - **Step 2** - will appear as follows:



NOTE

As each Step is completed, the user will be prompted to make appropriate changes to what has been entered, if the Auto-Configurator determines that the parameter entered is incorrect or inappropriate for the situation.

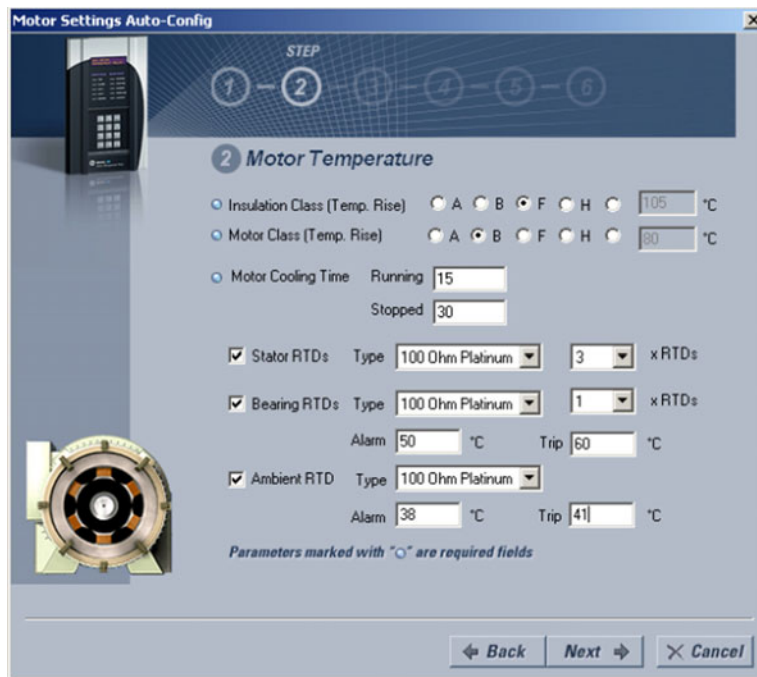

▷ Continue filling in the fields as indicated.

Once you have completed all 6 Steps, the final window will show as follows:



▷ Click **Finish** to complete the Auto-Config procedure. The Motor Settings Auto-Configurator window will disappear.

A new Settings File containing the parameters you have just input will appear in the Files pane as shown:

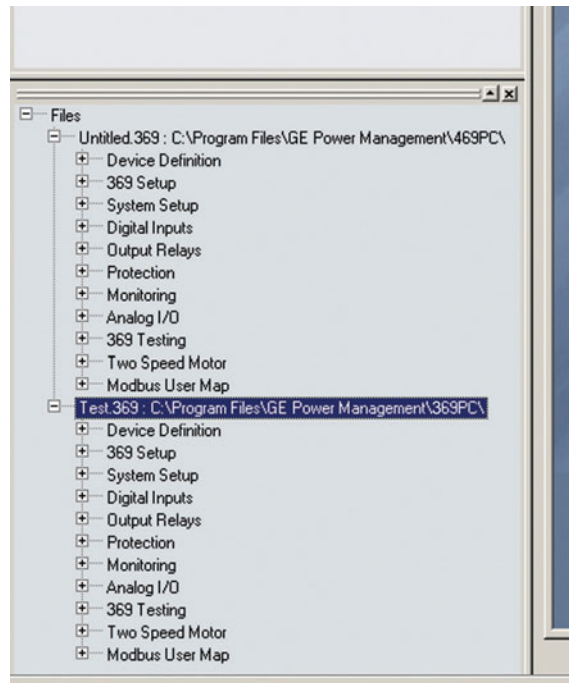

### Creating a New Settings File *without* using Motor Settings Auto-Config

The EnerVista 369 Setup software allows the user to create new Settings files independent of a connected device. These can be uploaded to a relay at a later date. The following manual procedure - as distinct from the Motor Settings Auto-Config option described above - illustrates how to create new Settings Files.

- ▷ In the File pane, right click on **File**.
- ▷ Select the **New Settings File** item.

The EnerVista 369 Setup software displays the following window, allowing the configuration of the Settings File as shown below.



**Note that this window allows you to choose between creating your Settings File manually or using the Motor Settings Auto-Configurator as detailed above.**



NOTE

It is important to define the correct firmware version to ensure that settings not available in a particular version are not downloaded into the relay

- ▷ Select the Firmware **Version** for the new Settings File.
- ▷ For future reference, enter some useful information in the **Description** box to facilitate the identification of the device and the purpose of the file.
- ▷ To select a file name and path for the new file, click the button beside the **File Name** box [...].
- ▷ Select the file name and path to store the file, or select any displayed file name to update an existing file.  
All 369 Relay Settings Files should have the extension '369 Relay' (for example, 'motor1.369 Relay').
- ▷ Click the appropriate radio button (**yes** or **no**) to choose between Auto-Configurator or manual creation of the Settings File.
- ▷ Click **OK** to complete the process.  
Once this step is completed, the new file, with a complete path, will be added to the EnerVista 369 Setup software environment.

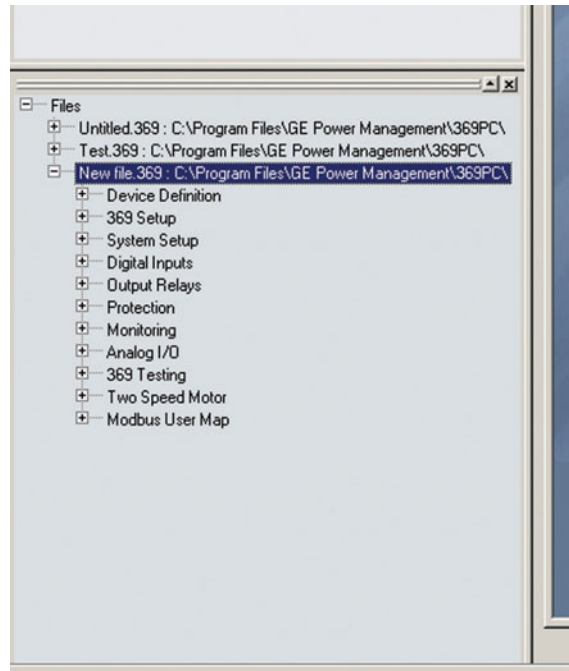

- ▷ Enter the appropriate settings manually to complete the new Settings File.

### Creating a New Setpoint File

The EnerVista 369 Setup software allows the user to create new setpoint files independent of a connected device. These can be uploaded to a relay at a later date. The following procedure illustrates how to create new setpoint files.

- ▷ In the File pane, right click on **File**.
- ▷ Select the **New Settings File** item.  
The EnerVista 369 Setup software displays the following box will appear, allowing the configuration of the setpoint file for the correct firmware version. It is important to define the correct firmware version to ensure that setpoints not available in a particular version are not downloaded into the relay.

- ▷ Select the firmware version.
- ▷ For future reference, enter some useful information in the Description box to facilitate the identification of the device and the purpose of the file.
- ▷ Enter any installed options (metering/backspin and Profibus), as well as the slave addresses of any remote RTDs.  
Note that the RRTD units must be connected in order from 1 to 4. If only one RRTD is used, its slave address must be programmed under RRTD1 Slave Address. The next RRTD to be connected would be set up under RRTD2 Slave Address, and so forth.
- ▷ To select a file name and path for the new file, click the button beside the **Enter File Name** box.
- ▷ Select the file name and path to store the file, or select any displayed file name to update an existing file.  
All 369 Relay setpoint files should have the extension '369 Relay' (for example, 'motor1.369 Relay').
- ▷ Click **Save** and **OK** to complete the process.  
Once this step is completed, the new file, with a complete path, will be added to the EnerVista 369 Setup software environment.

### Upgrading Setpoint Files to a New Revision

It is often necessary to upgrade the revision code for a previously saved setpoint file after the 369 Relay firmware has been upgraded (for example, this is required for firmware upgrades). This is illustrated in the following procedure.

- ▷ Establish communications with the 369 Relay.
- ▷ Select the **Actual > A5 Product** Info menu item and record the Software Revision identifier of the relay firmware.



- ▷ Load the setpoint file to be upgraded into the EnerVista 369 Setup environment as described in *Adding Setpoints Files to the Environment* on page 4–72.
- ▷ In the File pane, select the saved setpoint file.
- ▷ From the main window menu bar, select the **File > Properties** menu item.
- ▷ Note the **File Version** of the setpoint file.  
If this version (e.g. 5.00 shown below) is different from the Software Revision code noted in step 2, select a **New File Version** that matches the Software Revision code from the pull-down menu.

For example, if the firmware revision is 271600A4.000 (software revision 6.00) and the current setpoint file revision is 5.00, change the setpoint file revision to “6.0X”.

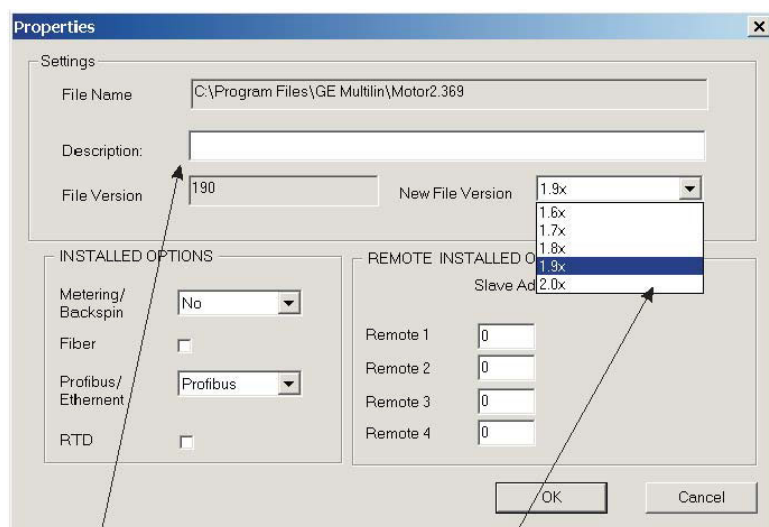

Enter any special comments about the setpoint file here.

Select the desired setpoint version from this menu. The 6.0x indicates versions 6.00, 6.01, 6.02, etc.

- ▷ When complete, click Convert to convert the setpoint file to the desired revision.  
A dialog box will request confirmation. See *Loading Setpoints from a File* on page 4–82 for instructions on loading this setpoint file into the 369 Relay.

### Printing Setpoints and Actual Values

The EnerVista 369 Setup software allows the user to print partial or complete lists of setpoints and actual values. Use the following procedure to print a list of setpoints:

- ▷ Select a previously saved setpoints file in the File pane or establish communications with a 369 Relay device.
- ▷ From the main window, select the **File > Print Settings** menu item.  
The Print/Export Options dialog box will appear.
- ▷ Select **Settings** in the upper section.

- ▷ Select either **Include All Features** (for a complete list) or **Include Only Enabled Features** (for a list of only those features which are currently used) in the filtering section.
- ▷ Click **OK**.

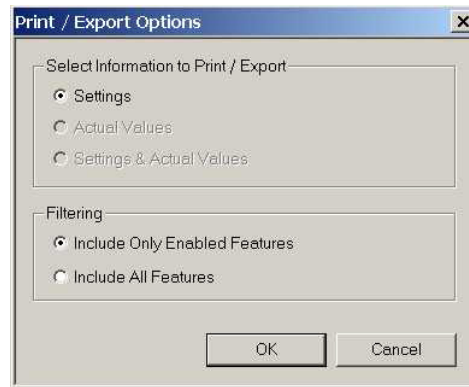

The process for **File > Print Preview Settings** is identical to the steps above.

Setpoints lists can be printed in the same manner by right clicking on the desired file (in the file list) or device (in the device list) and selecting the **Print Device Information** or **Print Settings File** options.

A complete list of actual values can also be printed from a connected device with the following procedure:

- ▷ Establish communications with the desired 369 Relay device.
- ▷ From the main window, select the **File > Print Settings** menu item. The Print/Export Options dialog box will appear.
- ▷ Select **Actual Values** in the upper section.
- ▷ Select either **Include All Features** (for a complete list) or **Include Only Enabled Features** (for a list of only those features which are currently used) in the filtering section.
- ▷ Click **OK**.
- ▷ Actual values lists can be printed in the same manner by right clicking on the desired device (in the device list) and selecting the **Print Device Information** option.

### Loading Setpoints from a File



**An error message will occur when attempting to download a setpoint file with a revision number that does not match the relay firmware. If the firmware has been upgraded since saving the setpoint file, see *Upgrading Setpoint Files to a New Revision* on page 4–80 for instructions on changing the revision number of a setpoint file.**

The following procedure illustrates how to load setpoints from a file. Before loading a setpoints file, it must first be added to the EnerVista 369 Setup environment as described in *Adding Setpoints Files to the Environment* on page 4–72.

- ▷ Select the previously saved setpoints file from the File pane of the EnerVista 369 Setup software main window.
- ▷ Select the **File > Properties** menu item and verify that the corresponding file is fully compatible with the hardware and firmware version of the target relay.  
If the versions are not identical, see *Upgrading Setpoint Files to a New Revision* on page 4–80 for details on changing the setpoints file version.
- ▷ Right-click on the selected file.
- ▷ Select the **Write Settings to Device** item.
- ▷ Select the target relay from the list of devices shown.
- ▷ Click **Send**.  
If there is an incompatibility, an error will occur: If there are no incompatibilities between the target device and the settings file, the data will be transferred to the relay. An indication of the percentage completed will be shown in the bottom of the main window.

## 4.5 Upgrading Relay Firmware

### 4.5.1 Description

To upgrade the 369 Relay firmware, follow the procedures listed in this section. Upon successful completion of this procedure, the 369 Relay will have new firmware installed with the original setpoints.

The latest firmware files are available from the GE Multilin website at <http://www.GEindustrial.com/multilin>.

### 4.5.2 Saving Setpoints to a File

Before upgrading firmware, it is very important to save the current 369 Relay settings to a file on your PC. After the firmware has been upgraded, it will be necessary to load this file back into the 369 Relay.

Refer to *Downloading and Saving Setpoints Files* on page 4–71 for details on saving relay setpoints to a file.

### 4.5.3 Loading New Firmware

Loading new firmware into the 369 Relay flash memory is accomplished as follows:

- ▷ Connect the relay to the local PC and save the setpoints to a file as shown in *Downloading and Saving Setpoints Files* on page 4–71.
- ▷ Select the **Communications > Update Firmware** menu item. The following warning message will appear: Select **Yes** to proceed or **No** to cancel the process.
- ▷ *Do NOT proceed unless you have saved the current setpoints.*

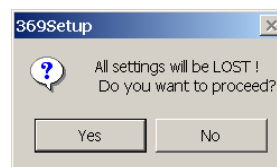

The EnerVista 369 Setup software will request the new firmware file.

- ▷ Locate the firmware file to load into the 369 Relay.  
The firmware filename has the following format:

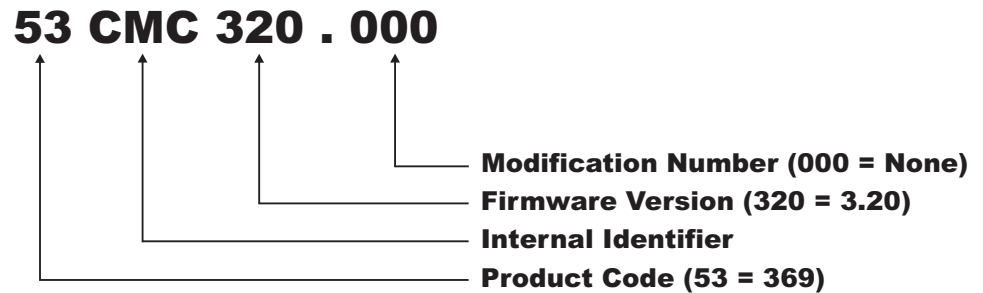

The EnerVista 369 Setup software automatically lists all filenames beginning with '53'.

- ▷ Select the appropriate file.
- ▷ Click **OK** to continue.

The software will prompt with another Upload Firmware Warning window. This will be the final chance to cancel the firmware upgrade before the flash memory is erased.

- ▷ Click **Yes** to continue or **No** to cancel the upgrade.

The EnerVista 369 Setup software now prepares the 369 Relay to receive the new firmware file. The 369 Relay will display a message indicating that it is in Upload Mode. While the file is being loaded into the 369 Relay, a status box appears indicating how much of the new firmware file has been transferred and how much is remaining, as well as the upgrade status. The entire transfer process takes approximately five minutes.

The EnerVista 369 Setup software will notify the user when the 369 Relay has finished loading the file.

- ▷ Carefully read any displayed messages.
- ▷ Click **OK** to return the main screen.



Cycling power to the relay is highly recommended after a firmware upgrade.

After successfully updating the 369 Relay firmware, the relay will not be in service and will require setpoint programming. To communicate with the relay, the following settings will have to be manually programmed.

**SLAVE ADDRESS**

**BAUD RATE**

**PARITY** (if applicable)

When communications is established, the saved setpoints must be reloaded back into the relay. See *Loading Setpoints from a File* on page 4–82 for details.

Modbus addresses assigned to firmware modules, features, settings, and corresponding data items (i.e. default values, min/max values, data type, and item size) may change slightly from version to version of firmware.

The addresses are rearranged when new features are added or existing features are enhanced or modified. The **EEPROM DATA ERROR** message displayed after upgrading/downgrading the firmware is a resettable, self-test message intended to inform users that the Modbus addresses have changed with the upgraded firmware. This message does not signal any problems when appearing after firmware upgrades.

---

## 4.6 Advanced EnerVista 369 Setup Features

### 4.6.1 Triggered Events

While the interface is in either on-line or off-line mode, data generated by triggered specified parameters can be viewed and analyzed via one of the following features:

- **Event Recorder:** The event recorder captures contextual data associated with the last 512 events, listed in chronological order from most recent to the oldest.
- **Oscillography:** The oscillography waveform traces and digital states provide a visual display of power system and relay operation data captured during specific triggered events.

### 4.6.2 Trending

Trending from the 369 Relay is accomplished via EnerVista 369 Setup. Many different parameters can be trended and graphed at sampling periods from 1 second up to 1 hour. The parameters which can be trended by EnerVista 369 Setup are:

- Currents/Voltages: phase currents A/B/C; average phase current; motor load; current unbalance; ground current; and voltages Vab, Vbc, Vca Van, Vbn and Vcn
- Power: power factor; real power (kW); reactive power (kvar); Apparent Power (kVA); positive watthours; positive varhours; and negative varhours
- Temperature: Hottest Stator RTD; RTDs 1 through 12; and RRTDs 1 through 12
- Other: thermal capacity used and system frequency
  - ▷ To use the Trending function, run the EnerVista 369 Setup software and establish communications with a connected 369 Relay unit.
  - ▷ Select the **Actual > Trending** menu item to open the Trending window.

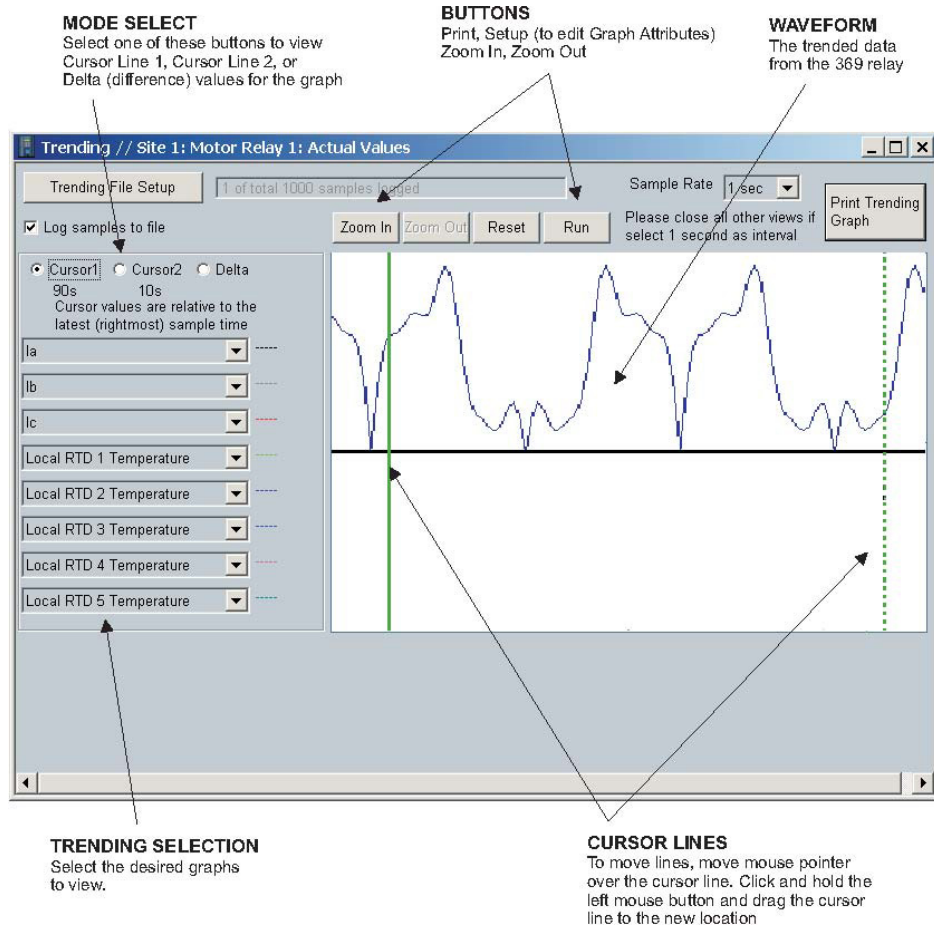

FIGURE 4-4: Trending View

- ▷ Program the parameters to display by selecting them from the pull down menus.
- ▷ Select the **Sample Rate**.
- ▷ Select **RUN** to begin the trending sampling.  
The trended values can be printed using **Print Trending Graph** button.  
The Trending File Setup button can be used to write the graph data to a file in a standard spreadsheet format.
- ▷ Ensure that the **Write Trended Data to File** box is checked, and that the **Sample Rate** is at a minimum of 5 seconds.
- ▷ Set the file capacity limit to the amount of memory available for trended data.



### 4.6.3 Waveform Capture (Trace Memory)

The EnerVista 369 Setup software can be used to capture waveforms (or view trace memory) from the 369 Relay relay at the instance of a trip. A maximum of 16 cycles can be captured and the trigger point can be adjusted to anywhere within the set cycles. The last three waveform events are viewable.

The following waveforms can be captured:

- Phase A, B, and C currents ( $I_a$ ,  $I_b$ , and  $I_c$ )
  - Ground and current ( $I_g$ )
  - Phase A-N, B-N, and C-N voltages ( $V_{an}$ ,  $V_{bn}$ , and  $V_{cn}$ ) if wye-connected  
Phase A-B and C-B ( $V_{ab}$  and  $V_{cb}$ ) if open-delta connected
  - Digital data for output relays and contact input states.
- ▷ With the EnerVista 369 Setup software running and communications established, select the **Actual > Waveform Capture** menu item to open the waveform capture setup window:

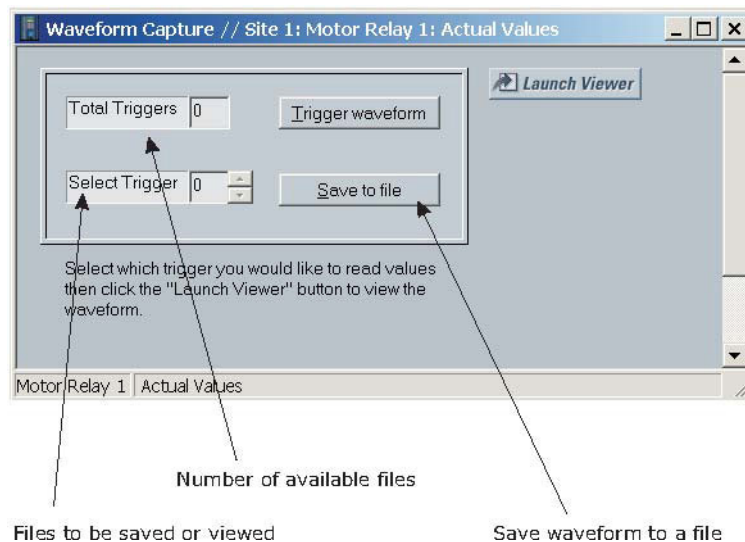

- ▷ Click on **Trigger Waveform** to trigger a waveform capture. The waveform file numbering starts with the number zero in the 369 Relay; therefore, the maximum trigger number will always be one less than the total number triggers available.
- ▷ Click on the **Save to File** button to save the selected waveform to the local PC. A new window will appear requesting for file name and path.

The file is saved as a COMTRADE File, with the extension 'CFG'. In addition to the COMTRADE file, two other files are saved. One is a CSV (comma delimited values) file, which can be viewed and manipulated with compatible third-party software. The other file is a DAT File, required by the COMTRADE file for proper display of waveforms.

- ▷ To view a previously saved COMTRADE File, click the **Open** button.
- ▷ Select the corresponding COMTRADE File.

- ▷ To view the captured waveforms, click the **Launch Viewer** button. A detailed Waveform Capture window will appear as shown below:

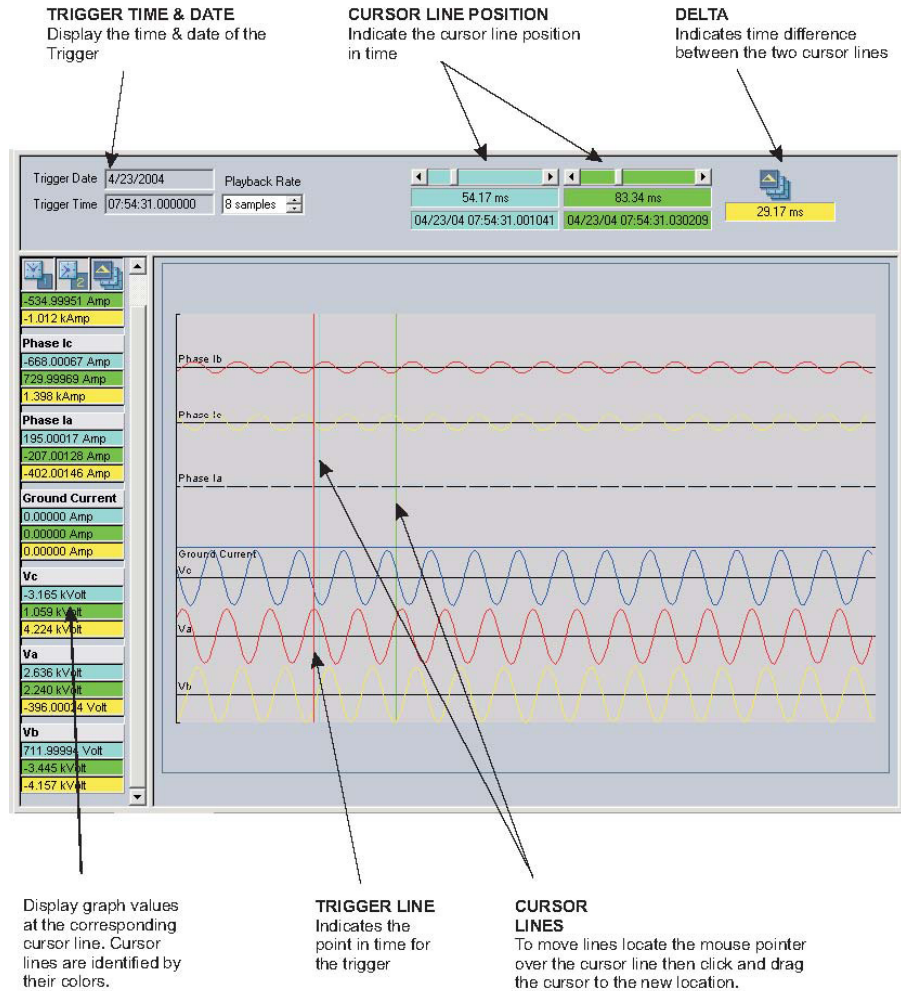

**FIGURE 4-5: Waveform Capture Window Attributes**

The red vertical line indicates the trigger point of the relay.

The date and time of the trip is displayed at the top left corner of the window. To match the captured waveform with the event that triggered it, make note of the time and date shown in the graph. Then, find the event that matches the same time and date in the event recorder. The event record will provide additional information on the cause and the system conditions at the time of the event. Additional information on how to download and save events is shown in *Event Recorder* on page 4-99.

#### 4.6.4 Motor Start Data Logger

In addition to the learned information captured for every start, the Motor Start Data Logger will record up to 30 seconds of digital and analog waveforms during motor starts. Captured information includes:

- Individual and average phase current
- Current unbalance
- Ground current
- Individual and average phase voltages
- Thermal capacity used
- System frequency
- Breaker status contact
- Motor speed (low/high)

#### 4.6.5 Data Logger

The user-configurable Data Logger allows users to trend information to help configure protection setpoints, as well as to schedule preventative maintenance. The Data Logger:

- allows trending of up to 16 analog or digital parameters at a time
- allows trending of any metered or calculated analog value within a provided list
- allows trending of digital input and output states
- stores all trended information in the relay's volatile memory (RAM)
- allows user-configurable resolution of trending from 1 second to 1 hour (3600s)
- allows up to 50 Logs to be created
- is available only with the Enhanced "E" option.

##### 4.6.5.1 Support in Enervista PC Software

Enervista PC Program supports the Data Logger on two screens on the **Online Device** tree:

1. **Setpoints: Settings > S1 Setup > Data Logger**
2. **Actual Values: Actual Values > A1 Motor Status > Data Logger**

### 4.6.5.2 Setpoints

Users can configure the Data Logger Settings from **Settings > S1 Setup > Data Logger**

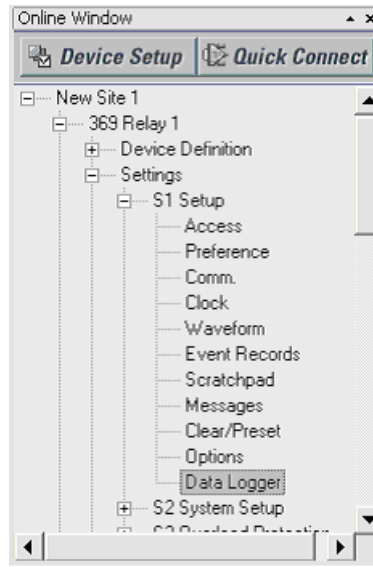

A typical Data Logger Settings screen is as follows:

Data Logger	
SETTING	PARAMETER
Log Interval	1 sec
Recording Type	Circulate
Channel 1 Log Assignment	Motor Thermal Capacity Used
Channel 2 Log Assignment	Digital Input and Output Relays Status
Channel 3 Log Assignment	Phase A Current
Channel 4 Log Assignment	Phase B Current
Channel 5 Log Assignment	Positive MegaWatthours
Channel 6 Log Assignment	Reactive Power
Channel 7 Log Assignment	Power Factor
Channel 8 Log Assignment	Negative Megavarhours
Channel 9 Log Assignment	Local RTD #9 Temperature
Channel 10 Log Assignment	RRTD 1 - Digital Input and Output Relays Status
Channel 11 Log Assignment	Vab
Channel 12 Log Assignment	Real Power (kW)
Channel 13 Log Assignment	Real Power (hp)
Channel 14 Log Assignment	Average Phase Current
Channel 15 Log Assignment	Average Line Voltage
Channel 16 Log Assignment	Local RTD #3 Temperature

The Settings in the Data Logger screen are:

**Log Interval :** The user can configure the Data Logger interval *1 sec to 3600 sec*

**Recording Type :** The user can select from the two available methods of logging.

**Run to Fill:** Allows logging of Channel data until the memory is full, then stops.

**Circulate:** Allows continuous logging of Channel data .

### 4.6.5.3 Channel 1 to 16 Assignment

Users can configure 16 channels from the available 102 inputs (97 Analog inputs and 5 Digital Inputs/Outputs) from the screen.

The following is the list of Inputs which can be assigned to any of the 16 Channels:

1	Motor Thermal Capacity Used	35	Local RTD #5 Temperature	69	RRTD 2 - RTD #7 Temperature
2	Digital Input and Output Relays Status	36	Local RTD #6 Temperature	70	RRTD 2 - RTD #8 Temperature
3	Phase A Current	37	Local RTD #7 Temperature	71	RRTD 2 - RTD #9 Temperature
4	Phase B Current	38	Local RTD #8 Temperature	72	RRTD 2 - RTD #10 Temperature
5	Phase C Current	39	Local RTD #9 Temperature	73	RRTD 2 - RTD #11 Temperature
6	Average Phase Current	40	Local RTD #10 Temperature	74	RRTD 2 - RTD #12 Temperature
7	Motor Load	41	Local RTD #11 Temperature	75	RRTD 3 - RTD #1 Temperature
8	Current Unbalance	42	Local RTD #12 Temperature	76	RRTD 3 - RTD #2 Temperature
9	Unbalanced Biased Motor Load	43	Current Demand	77	RRTD 3 - RTD #3 Temperature
10	Ground Current	44	Real Power Demand	78	RRTD 3 - RTD #4 Temperature
11	Vab	45	Reactive Power Demand	79	RRTD 3 - RTD #5 Temperature
12	Vbc	46	Apparent Power Demand	80	RRTD 3 - RTD #6 Temperature
13	Vca	47	Peak Current Demand	81	RRTD 3 - RTD #7 Temperature
14	Average Line Voltage	48	Peak Real Power Demand	82	RRTD 3 - RTD #8 Temperature
15	Van	49	Peak Reactive Power Demand	83	RRTD 3 - RTD #9 Temperature
16	Vbn	50	Peak Apparent Power Demand	84	RRTD 3 - RTD #10 Temperature
17	Vcn	51	RRTD 1 - RTD #1 Temperature	85	RRTD 3 - RTD #11 Temperature
18	Average Phase Voltage	52	RRTD 1 - RTD #2 Temperature	86	RRTD 3 - RTD #12 Temperature
19	System Frequency	53	RRTD 1 - RTD #3 Temperature	87	RRTD 4 - RTD #1 Temperature
20	Power Factor	54	RRTD 1 - RTD #4 Temperature	88	RRTD 4 - RTD #2 Temperature
21	Real Power (kW)	55	RRTD 1 - RTD #5 Temperature	89	RRTD 4 - RTD #3 Temperature
22	Real Power (hp)	56	RRTD 1 - RTD #6 Temperature	90	RRTD 4 - RTD #4 Temperature
23	Reactive Power	57	RRTD 1 - RTD #7 Temperature	91	RRTD 4 - RTD #5 Temperature

24	Apparent Power	58	RRTD 1 - RTD #8 Temperature	92	RRTD 4 - RTD #6 Temperature
25	Positive MegaWatthours	59	RRTD 1 - RTD #9 Temperature	93	RRTD 4 - RTD #7 Temperature
26	Positive Megavarhours	60	RRTD 1 - RTD #10 Temperature	94	RRTD 4 - RTD #8 Temperature
27	Negative Megavarhours	61	RRTD 1 - RTD #11 Temperature	95	RRTD 4 - RTD #9 Temperature
28	Positive KiloWatthours	62	RRTD 1 - RTD #12 Temperature	96	RRTD 4 - RTD #10 Temperature
29	Positive KiloVarhours	63	RRTD 2 - RTD #1 Temperature	97	RRTD 4 - RTD #11 Temperature
30	Negative KiloVarhours	64	RRTD 2 - RTD #2 Temperature	98	RRTD 4 - RTD #12 Temperature
31	Local RTD #1 Temperature	65	RRTD 2 - RTD #3 Temperature	99	RRTD 1 - Digital Input and Output Relays Status
32	Local RTD #2 Temperature	66	RRTD 2 - RTD #4 Temperature	100	RRTD 2 - Digital Input and Output Relays Status
33	Local RTD #3 Temperature	67	RRTD 2 - RTD #5 Temperature	101	RRTD 3 Digital Input and Output Relays Status
34	Local RTD #4 Temperature	68	RRTD 2 - RTD #6 Temperature	102	RRTD 4 Digital Input and Output Relays Status

**4.6.5.4 Actual Values**

**Actual Values > A1 Motor Status > Data Logger**

This screen can be used to monitor the Datalog status , View and Save the Datalog, as well as perform the Start/Stop operation on the Data Logger.

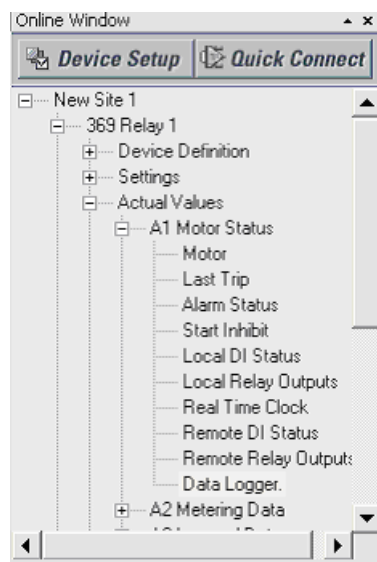

A typical Actual Values screen is as follows:

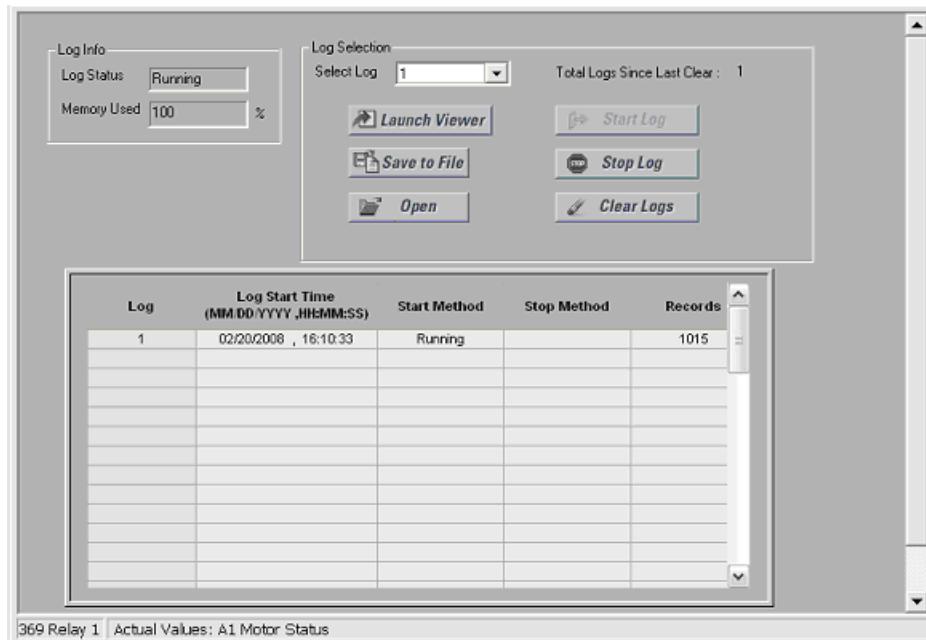

4.6.5.5 Log Status

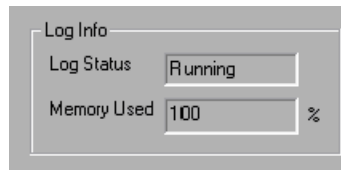

**Log Status** displays the current state of the Data Logger, either Running or Stopped.

**Memory Used** displays the memory usage in % of total memory of the data logger which varies from 0 to 100 %.

4.6.5.6 Log Selection and Waveform View

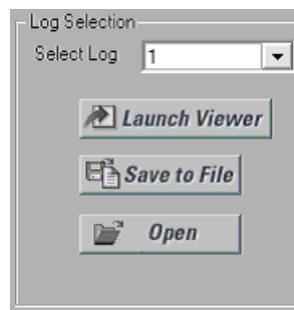

**Select Log** allows the user to select a Log from the available logs ( maximum 50 logs available).

**Launch Viewer button** allows the user to launch and view the trend for the selected log from the drop down box.

**Save to File button** allows the user to save the selected log as .CSV and .CFG file which can be opened from the viewer (setup software) in offline mode.

**Open button** allows the user to open CSV and CFG files in offline mode and view the trending information from a Log.

**4.6.5.7 Start /Stop/Clear Operations on the Datalogger**

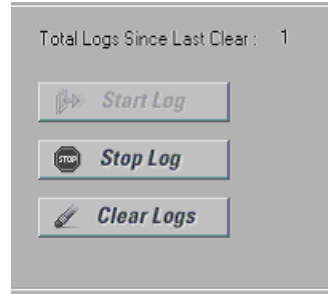

**Start Log button** allows the user to start a new Log in the Datalogger.

**Stop Log button** allows the user to stop a Log that is currently running

**Clear Logs button** allows the user to clear all the available Logs in the Datalogger memory.

**Total Logs Since Last Clear** displays the number of Logs generated in data logger since the last time the datalogger was cleared. The number varies from 0 to 65535. Starting a new Log increments this value by 1. Clicking on Clear Logs reverts this value to 0.

**4.6.5.8 Log information grid**

Log	Log Start Time (MM/DD/YYYY ,HH:MM:SS)	Start Method	Stop Method	Records
1	02/20/2008 , 16:47:38	Manual Start	Manual Stop	5
2	02/20/2008 , 16:47:48	Running		3

**Log column** displays the Log numbers that are currently available in the Datalogger memory



**Log Start Time column** displays the Date and Time (in MM/DD/YYYY, HH:MM:SS format) when the corresponding Log is generated

**Start Method column** displays the method by which the Log is started. This value can be either

- **Manual Start** - if the Log is generated by clicking the **Start** button
- **Motor Start** - if the Log is generated when the Motor is started from the OFF state.

**Stop Method column** displays the method by which the Log is stopped. This value can be either

- **Manual Stop** - if the Log is stopped by clicking the **Stop** button
- **Motor Stop** - if the Log is stopped when the motor is stopped from the Running state.

**Records column** displays the number of records stored in each Log.

#### 4.6.5.9 Grid Update

If the screen is kept open when the Data Log is running, information in the grid is automatically updated in the following cases:

- Start of a new Log (either manual start or motor start)
- Stopping the current Log (either manual stop or motor stop)
- Any of the existing Logs are erased when the log is running in Circulate mode
- Clearing the existing Logs.



**If any of the above events do not occur, the data log screen will be updated automatically every 60 seconds.**

#### 4.6.6 Motor Health Report

This reporting function is included with every 369 relay, providing critical information on the historical operating characteristics of your motor during motor starting and stopping operations. Included in the report are:

- Trip summary
- Motor operation historical timeline, displaying start, emergency restart, stop, trip, and alarm conditions
- Motor starting learned information (trending information over a maximum of 1250 motor start operations)
- Motor start data logger trends, including current, current unbalance, voltage, frequency, TCU, breaker contact status during start, and motor speed (low/high).

#### 4.6.7 Phasors

The EnerVista 369 Setup software can be used to view the phasor diagram of three-phase currents and voltages. The phasors are for: Phase Voltages Va, Vb, and Vc; Phase Currents Ia, Ib, and Ic.

- ▷ With the EnerVista 369 Setup software running and communications established, open the **Actual Values > Metering Data** window, then
- ▷ Click on the **Phasors** tab.  
The EnerVista 369 Setup software will display the following window:

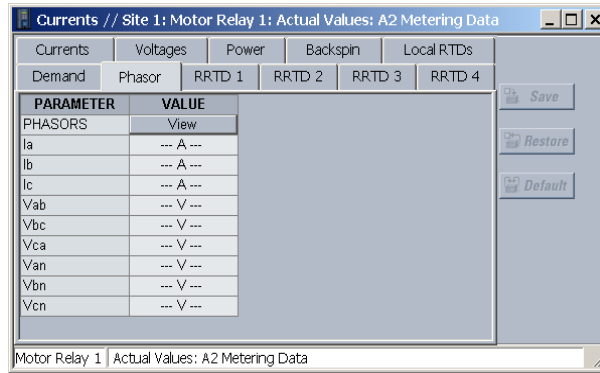

- ▷ Press the "View" button to display the following window:

**VOLTAGE LEVEL**  
Displays the value and the angle of the voltage phasors

**CURRENT LEVEL**  
Displays the value and angle of the current phasor

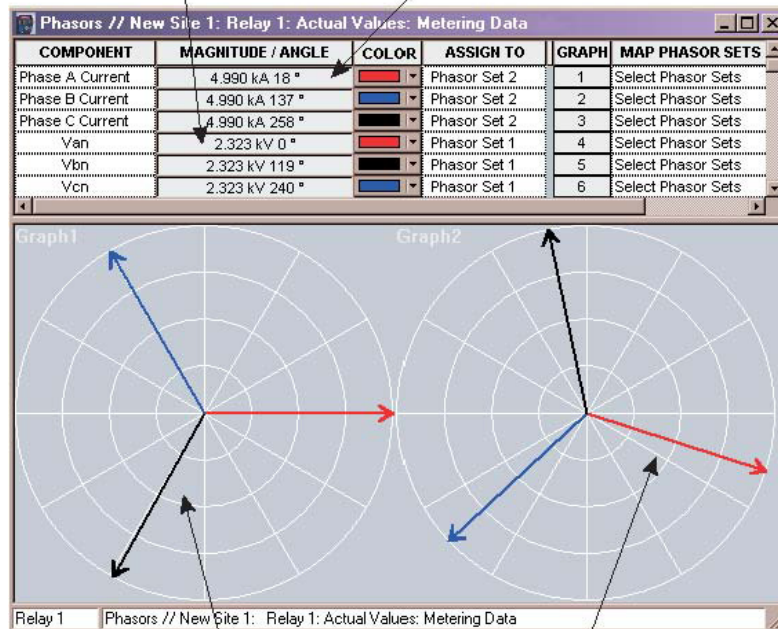

**VOLTAGE VECTORS**  
Assigned to Phasor Set 1, Graph 1

**CURRENT VECTORS**  
Assigned to Phasor Set 2, Graph 2

The 369 Motor Management Relay was designed to display lagging angles. Therefore, if a system condition would cause the current to lead the voltage by 45°, the 369 Relay relay will display such angle as 315° Lag instead of 45° Lead.



**When the currents and voltages measured by the relay are zero, the angles displayed by the relay and those shown by the EnerVista 369 Setup software are not fixed values.**

#### 4.6.8 Event Recorder

The 369 Relay event recorder can be viewed through the EnerVista 369 Setup software. The event recorder stores motor and system information each time an event occurs (e.g. breaker failure). The 369 Relay supports 512 event records. Event 512 is the most recent event and Event 001 is the oldest event. Event 001 is overwritten whenever a new event occurs. Refer to *Event Records* on page 6–20 for additional information on the event recorder.

Use the following procedure to view the event recorder with EnerVista 369 Setup:

- ▷ With EnerVista 369 Setup running and communications established, select the **Actual > A5 Event Recorder** item from the main menu. This displays the Event Recorder window indicating the list of recorded events, with the most current event displayed first.

**EVENT NUMBER**  
The event data information is related to the event number shown here.

**EVENT LISTING**  
Lists the last 128 events with the most recent displayed at top of list.

**CLEAR EVENTS**  
Click the Clear Events button to clear the event list from memory.

Event	Date	Time	Cause of Event
1			
2			
3			
4			
5			
6			
7			
8			
9			
10			
11			
12			
13			
14			
15			

Event Parameter	Value
Event Ia	
Event Ib	
Event Ic	
Event Motor Load	
Event Current Unbalance	
Event Ig	
Event Hottest Stator RTD	
Event Temperature of Hottest Stator RT	
Event Vab	
Event Vbc	
Event Vca	
Event Van	
Event Vbn	
Event Vcn	
Event System Frequency	

**EVENT DATA**  
System information as measured by the relay at the instant of the event occurrence.

**SAVE EVENTS**  
Click the Save Events button to save the event record to the PC as a CSV file.

Last Reset Date  
Total Events  
Clear Events  
Save Events  
To view event data please click on event number column in the event list

- ▷ To view detailed information for a given event and the system information at the moment of the event occurrence, change the event number on the **Select Event** box.

### 4.6.9 Modbus User Map

The EnerVista 369 Setup software provides a means to program the 369 Relay User Map (Modbus addresses 0180h to 01FCh). Refer to *User Definable Memory Map Area in the 369 Communications Guide* for additional information on the User Map.

- ▷ Select a connected device in EnerVista 369 Setup.
- ▷ Select the **Setpoint > User Map** menu item to open the following window.

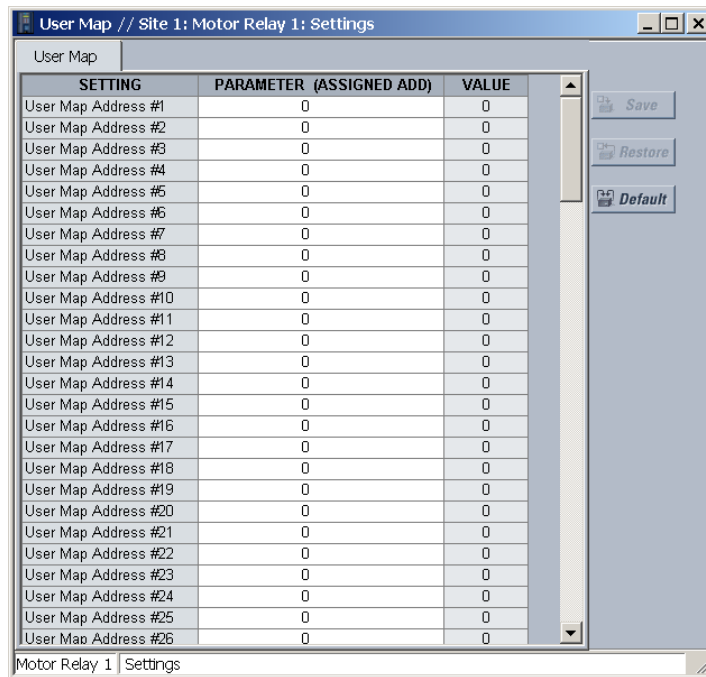

The above window allows the desired addresses to be written to User Map locations. The User Map values that correspond to these addresses are then displayed.

### 4.6.10 Viewing Actual Values

You can view real-time relay data such as input/output status and measured parameters. From the main window menu bar, selecting Actual Values opens a window with tabs, each tab containing data in accordance to the following list:

- **Motor Status:** Motor, Last Trip, Alarm Status, Start Inhibit, Local DI Status, Local Relay Outputs, and Real Time Clock
- **Metering Data:** Currents, Voltages, Power, Backspin, Local RTDs, Demand, Phasor, and RRTDs 1 to 4
- **Learned Data:** Motor Learned Data, Local RTD Maximums, RRTD 1 to 4 Maximums
- **Statistical Data:** Trip Counters and Motor Statistics
- **Product Information:** Revision Codes and Calibration Dates

Selecting an actual values window also opens the actual values tree from the corresponding device in the site list and highlights the current location in the hierarchy.

For complete details on actual values, refer to Chapter 6.

- ▷ To view a separate window for each group of actual values, select the desired item from the tree.
- ▷ Double click with the left mouse button.  
Each group will be opened on a separate tab. The windows can be rearranged to maximize data viewing as shown in the following figure (showing actual current, voltage, and power values tiled in the same window):

## 4.7 Using EnerVista Viewpoint with the 369 Relay

### 4.7.1 Plug and Play Example

EnerVista Viewpoint is an optional software package that puts critical 369 Relay information onto any PC with plug-and-play simplicity. EnerVista Viewpoint connects instantly to the 369 Relay via serial, ethernet or modem and automatically generates detailed overview, metering, power, demand, energy and analysis screens. Installing EnerVista Launchpad (see previous section) allows the user to install a fifteen-day trial version of enerVista Viewpoint. After the fifteen day trial period you will need to purchase a license to continue using enerVista Viewpoint. Information on license pricing can be found at <http://www.enerVista.com>.

- ▷ Install the EnerVista Viewpoint software from the GE enerVista CD.
- ▷ Ensure that the 369 Relay device has been properly configured for either serial or Ethernet communications (see previous sections for details).
- ▷ Click the **Viewpoint** window in EnerVista to log into EnerVista Viewpoint.  
At this point, you will be required to provide a login and password if you have not already done so.



FIGURE 4-6: enerVista Viewpoint Main Window

- ▷ Click the **Device Setup** button to open the Device Setup window.
- ▷ Click the **Add Site** button to define a new site.
- ▷ Enter the desired site name in the **Site Name** field.  
If desired, a short description of site can also be entered along with the display order of devices defined for the site.
- ▷ Click the **OK** button when complete.  
The new site will appear in the upper-left list in the EnerVista 369 Setup window.

- ▷ Click the **Add Device** button to define the new device.
- ▷ Enter the desired name in the **Device Name** field and a description (optional) of the site.
- ▷ Select the appropriate communications interface (Ethernet or Serial) and fill in the required information for the 369 Relay.  
See *Connecting EnerVista 369 Setup to the Relay* on page 4–63 for details.

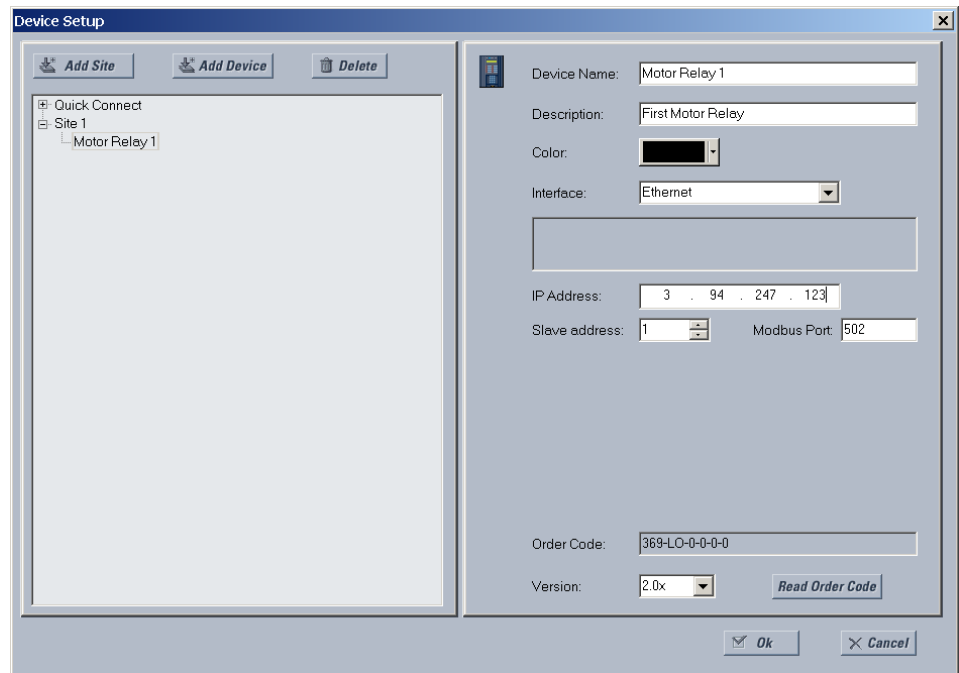

FIGURE 4–7: Device Setup Screen (Example)

- ▷ Click the **Read Order Code** button to connect to the 369 Relay device and upload the order code.  
If a communications error occurs, ensure that communications values entered in the previous step correspond to the relay setting values.
- ▷ Click **OK** when complete.
- ▷ From the EnerVista main window, select the **IED Dashboard** item to open the Plug and Play IED dashboard.  
An icon for the 369 Relay will be shown.



FIGURE 4-8: 'Plug and Play' Dashboard

- ▷ Click the **Dashboard** button below the 369 Relay icon to view the device information.  
We have now successfully accessed our 369 Relay through EnerVista Viewpoint.



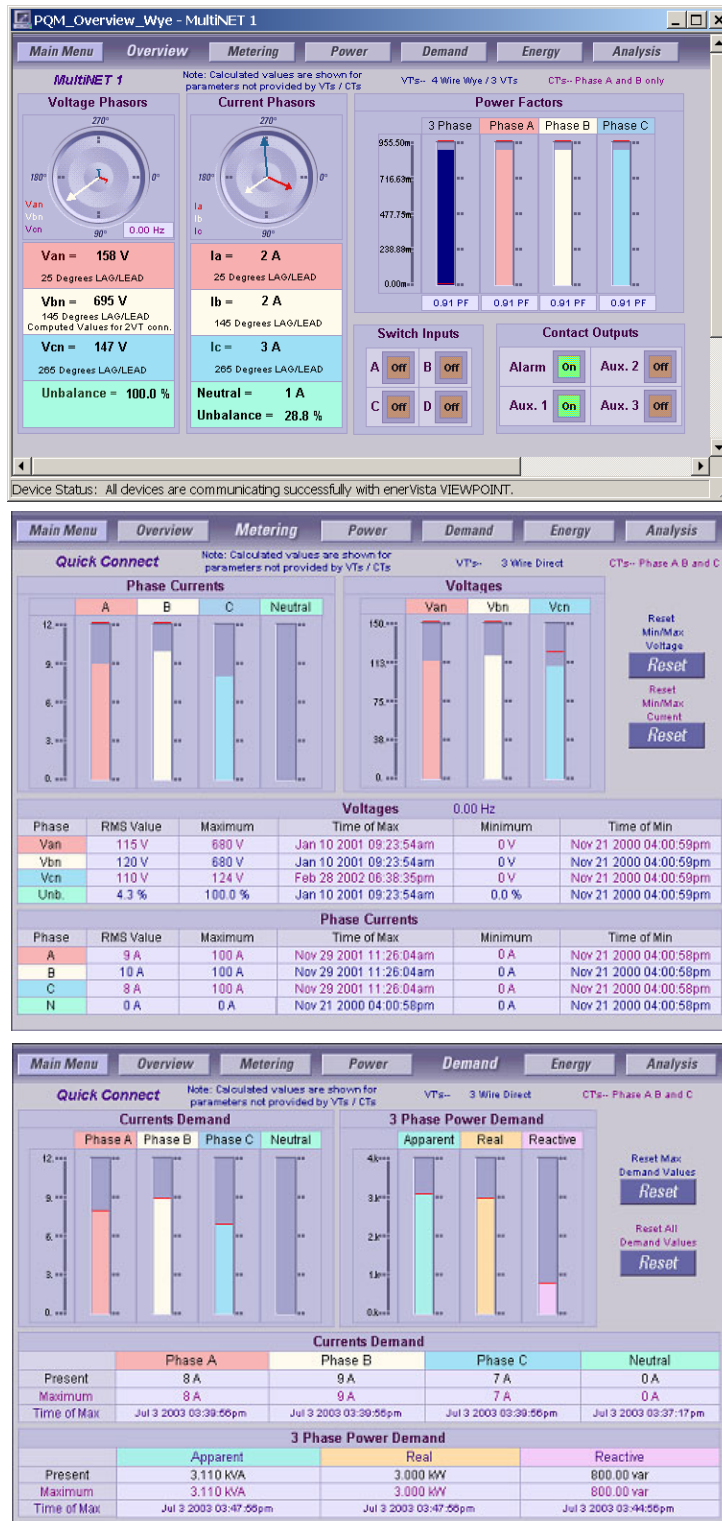

FIGURE 4-9: EnerVista Plug and Play Screens (Example)

For additional information on EnerVista viewpoint, please visit the EnerVista website at <http://www.EnerVista.com>.













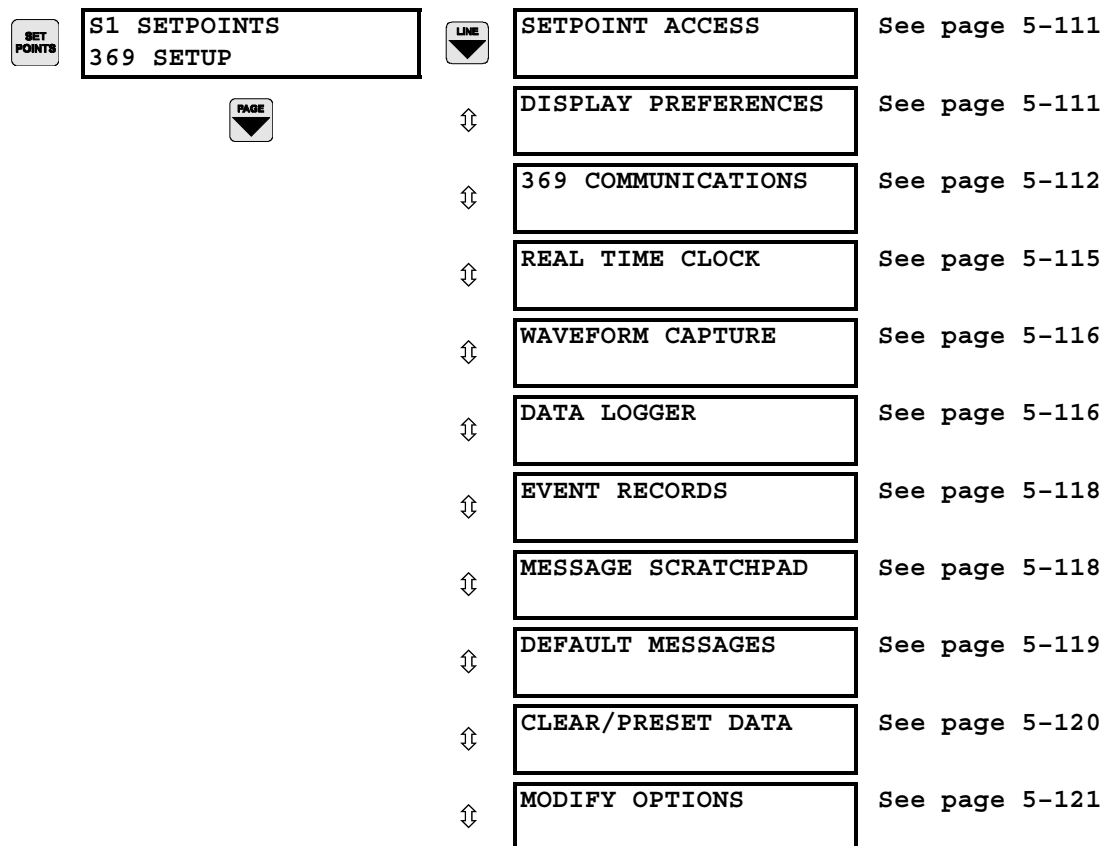















# 369 Motor Management Relay

## Chapter 5: Setpoints

### 5.1 Overview

#### 5.1.1 Setpoints Main Menu



		<b>FACTORY SERVICE</b>	See page 5-121
			
<b>S2 SETPOINTS SYSTEM SETUP</b>		<b>CT/VT SETUP</b>	See page 5-122
		<b>MONITORING SETUP</b>	See page 5-125
		<b>BLOCK FUNCTIONS</b>	
		<b>OUTPUT RELAY SETUP</b>	See page 5-130
		<b>CONTROL FUNCTIONS</b>	See page 5-131
			
<b>S3 SETPOINTS OVERLOAD PROTECTION</b>		<b>THERMAL MODEL</b>	See page 5-142
		<b>OVERLOAD CURVES</b>	See page 5-144
		<b>OVERLOAD ALARM</b>	See page 5-154
			
<b>S4 SETPOINTS CURRENT ELEMENTS</b>		<b>SHORT CIRCUIT</b>	See page 5-155
		<b>MECHANICAL JAM</b>	See page 5-156
		<b>UNDERCURRENT</b>	See page 5-157
		<b>CURRENT UNBALANCE</b>	See page 5-158
		<b>GROUND FAULT</b>	See page 5-159
			
<b>S5 SETPOINTS MOTOR START/INHIBITS</b>		<b>ACCELERATION TRIP</b>	See page 5-161
		<b>START INHIBIT</b>	See page 5-162
		<b>BACKSPIN DETECTION</b>	See page 5-163
			
<b>S6 SETPOINTS RTD TEMPERATURE<sup>1</sup></b>		<b>LOCAL RTD PROTECTION<sup>2</sup></b>	See page 5-165

PAGE ▼	⇕	REMOTE RTD PROTECTN <sup>3</sup>	See page 5-166
	⇕	OPEN RTD ALARM	See page 5-169
	⇕	SHORT/LOW RTD ALARM	See page 5-169
	▲ LINE	LOSS OF RRTD COMMS	See page 5-170
▲ PAGE		<b>S7 SETPOINTS VOLTAGE ELEMENTS</b>	
PAGE ▼	⇕	UNDERVOLTAGE <sup>4</sup>	See page 5-171
	⇕	OVERVOLTAGE <sup>4</sup>	See page 5-172
	⇕	PHASE REVERSAL	See page 5-173
	⇕	UNDERFREQUENCY	See page 5-175
	▲ LINE	OVERFREQUENCY	See page 5-176
▲ PAGE		<b>S8 SETPOINTS POWER ELEMENTS<sup>4</sup></b>	
PAGE ▼	⇕	LEAD POWER FACTOR	See page 5-178
	⇕	LAG POWER FACTOR	See page 5-179
	⇕	POSITIVE REACTIVE POWER (kvar)	See page 5-179
	⇕	NEGATIVE REACTIVE POWER (kvar)	See page 5-180
	⇕	UNDERPOWER	See page 5-182
	▲ LINE	REVERSE POWER	See page 5-183
▲ PAGE		<b>S9 SETPOINTS DIGITAL INPUTS</b>	
PAGE ▼	⇕	SPARE SWITCH	See page 5-186
	⇕	EMERGENCY RESTART	See page 5-187
	⇕	DIFFERENTIAL	See page 5-187
	⇕	SPEED SWITCH	See page 5-188
	▲ LINE	REMOTE RESET	See page 5-189



▲ PAGE	S10 SETPOINTS ANALOG OUTPUTS	LINE ▼	ANALOG OUTPUT 1	See page 5-190
PAGE ▼		↕	ANALOG OUTPUT 2	
		↕	ANALOG OUTPUT 3	
		▲ LINE	ANALOG OUTPUT 4	
▲ PAGE	S11 SETPOINTS 369 TESTING	LINE ▼	TEST OUTPUT RELAYS	See page 5-192
PAGE ▼		↕	TEST ANALOG OUTPUTS	See page 5-193
▲ PAGE	S12 SETPOINTS TWO-SPEED MOTOR	LINE ▼	SPEED2 O/L CURVES	See page 5-194
		↕	SPEED2 UNDERCURRENT	See page 5-196
		↕	SPEED2 ACCELERATION	See page 5-197

- 1. Only shown if option R installed or Channel 3 Application is programmed as RRTD
- 2. Only shown if option R installed
- 3. Only shown if Channel 3 Application is programmed as RRTD
- 4. Only shown if option M or B are installed

## 5.2 S1 369 Setup

### 5.2.1 Setpoint Access

PATH: S1 369 SETUP ↕ SETPOINT ACCESS

SETPOINT ACCESS		FRONT PANEL ACCESS: Read & Write	Range: Read Only, Read & Write
		COMM ACCESS Read & Write	Range: Read Only, Read & Write
		ENCRYPTED COMM PASSCODE: AIKFBAIK	Range: 8 alphabetic characters





There are two levels of access security: “Read Only” and “Read & Write”. The access terminals (57 and 58) must be shorted to gain read/write access via the front panel. The **FRONT PANEL ACCESS** setpoint indicates the access level based on the condition of the access switch. If set to “Read Only”, setpoints and actual values may be viewed but, not changed. If set to “Read & Write”, actual values may be viewed and setpoints changed and stored.

Communication access can be changed with EnerVista 369 Setup via the **Setpoint > S1 Setup** menu. An access tab is shown only when communicating with the relay. To set a password, click the **Change Password** button, then enter and verify the new passcode. After a passcode is entered, setpoint access changes to “Read Only”. When setpoints are changed through EnerVista 369 Setup during read-only access, the passcode must be entered to store the new setpoint. To allow extended write access, click **Allow Write Access** and enter the passcode. To return the access level to read-only, click **Restrict Write Access**. Access automatically reverts to read-only after 30 minutes of inactivity or if control power is cycled.

If the access level is Read/Write, write access to setpoints is automatic and a 0 password need not be entered. If the password is not known, consult the factory service department with the **ENCRYPTED COMM PASSCODE** value to be decoded.

### 5.2.2 Display Preferences

PATH: S1 369 SETUP ↕↕ DISPLAY PREFERENCES

DISPLAY PREFERENCES		DEFAULT MESSAGE CYCLE TIME: 20 s	Range: 5 to 100 s in steps of 1
		DEFAULT MESSAGE TIMEOUT: 300 s	Range: 10 to 900 s in steps of 1
		FLASH MESSAGE DURATION: 2s	Range: 1 to 10 s in steps of 1
		TEMPERATURE DISPLAY: Celsius	Range: Celsius, Fahrenheit Shown if option R installed or RRTD added
		ENERGY UNIT DISPLAY: Mega	Range: Mega, Kilo Shown only if option M or B installed

If no keys are pressed for the time defined by the **DEFAULT MESSAGE TIMEOUT**, the 369 automatically displays a series of default messages. This time can be modified to ensure messages remain on the screen long enough during programming or reading of actual values. Each default message remains on the screen for the default message cycle time.

Flash messages are status, warning, error or information messages displayed for several seconds in response to certain key presses during setpoint programming. These messages override any normal messages. The duration of a flash message on the display can be changed to accommodate different reading rates.

Temperatures may be displayed in either Celsius or Fahrenheit degrees. RTD setpoints are programmed in Celsius only.

The energy units for watthours and varhours can be viewed in either “Mega” (MWh or Mvarh) or “Kilo” (kWh or kvarh) units. Both registers accumulate energy regardless of the preference set. The actual energy is a summation of both the kilo and Mega values.

### 5.2.3 369 Communications

PATH: S1 369 SETUP ↓↓↓ 369 COMMUNICATIONS

<b>369 COMMUNICATIONS</b>	ENTER	<b>SLAVE ADDRESS:</b> 254	Range: 1 to 254 in steps of 1
	LINE ▼	<b>COMPUTER RS232 BAUD RATE: 19200 Baud</b>	Range: 4800, 9600, 19200
	⇅	<b>COMPUTER RS232 PARITY: None</b>	Range: None, Odd, Even
	⇅	<b>CHANNEL 1 RS485 BAUD RATE: 19200 Baud</b>	Range: 1200, 2400, 4800, 9600, 19200
	⇅	<b>CHANNEL 1 RS485 PARITY: None</b>	Range: None, Odd, Even
	⇅	<b>CHANNEL 2: RS485 BAUD RATE: 19200 Baud</b>	Range: 1200, 2400, 4800, 9600, 19200
	⇅	<b>CHANNEL 2: RS485 PARITY: None</b>	Range: None, Odd, Even
	⇅	<b>CHANNEL 3 APPLICATION: Modbus</b>	Range: Modbus, RRTD
	⇅	<b>CHANNEL 3 CONNECTION: RS485</b>	Range: RS485, Fiber. Only shown if option F is installed.
	⇅	<b>CHANNEL 3 RS485 BAUD RATE: 19200 Baud</b>	Range: 1200, 2400, 4800, 9600, 19200
	⇅	<b>CHANNEL 3 RS485 PARITY: None</b>	Range: None, Odd, Even
	⇅	<b>RRTD #1 ADDRESS<sup>1</sup>: RRTD not available</b>	Range: 0 to 254 in steps of 1 or RRTD not available
	⇅	<b>RRTD #2 ADDRESS<sup>1</sup>: RRTD not available</b>	Range: 0 to 254 in steps of 1 or RRTD not available



⇕	<b>RRTD #3 ADDRESS<sup>1</sup>:</b> RRTD not available	Range: 0 to 254 in steps of 1 or RRTD not available
⇕	<b>RRTD #4 ADDRESS<sup>1</sup>:</b> RRTD not available	Range: 0 to 254 in steps of 1 or RRTD not available
⇕	<b>PROFIBUS ADDRESS:</b> 125	Range: 1 to 126 in steps of 1 Only in models with Profibus (Option P or P1)
⇕	<b>PROFIBUS CYCLIC IN DATA:</b> Default Map	Range: 0 (use Default Input Data Map) to 110 registers Only in models with Profibus-DPV1 (option P1)
⇕	<b>FIELDBUS LOSS OF COMMUNICATION:</b> Off	Range: Off, Latched, Unlatched Only in models with Profibus, Ethernet & DeviceNet Option (option P, P1,E & D)
⇕	<b>FIELDBUS LOSS OF COMMS DELAY<sup>2</sup>:</b> 0.25 s	Range: 0.25 s to 10.0 s in steps of 0.25 s Only in models with Profibus & Ethernet (option P, P1, & E).
⇕	<b>ASSIGN LOSS OF COMMS RELAY<sup>2</sup>:</b> Trip	Range: None, Trip, Alarm, Aux 1, Aux 2, or combinations of these. Only in models with Profibus & Ethernet (option P, P1, & E).
⇕	<b>IP ADDRESS OCTET 1:</b> 127	Range: 0 to 255 in steps of 1 Shown only with Modbus/TCP (Option E)
⇕	<b>IP ADDRESS OCTET 2:</b> 0	Range: 0 to 255 in steps of 1 Shown only with Modbus/TCP (Option E)
⇕	<b>IP ADDRESS OCTET 3:</b> 0	Range: 0 to 255 in steps of 1 Shown only with Modbus/TCP (Option E)
⇕	<b>IP ADDRESS OCTET 4:</b> 1	Range: 0 to 255 in steps of 1 Shown only with Modbus/TCP (Option E)
⇕	<b>SUBNET MASK OCTET 1:</b> 255	Range: 0 to 255 in steps of 1 Shown only with Modbus/TCP (Option E)
⇕	<b>SUBNET MASK OCTET 2:</b> 255	Range: 0 to 255 in steps of 1 Shown only with Modbus/TCP (Option E)
⇕	<b>SUBNET MASK OCTET 3:</b> 255	Range: 0 to 255 in steps of 1 Shown only with Modbus/TCP (Option E)
⇕	<b>SUBNET MASK OCTET 4:</b> 0	Range: 0 to 255 in steps of 1 Shown only with Modbus/TCP (Option E)
⇕	<b>GATEWAY ADD. OCTET 1:</b> 127	Range: 0 to 255 in steps of 1 Shown only with Modbus/TCP (Option E)
⇕	<b>GATEWAY ADD. OCTET 2:</b> 0	Range: 0 to 255 in steps of 1 Shown only with Modbus/TCP (Option E)
⇕	<b>GATEWAY ADD. OCTET 3:</b> 0	Range: 0 to 255 in steps of 1 Shown only with Modbus/TCP (Option E)
⇕	<b>GATEWAY ADD. OCTET 4:</b> 1	Range: 0 to 255 in steps of 1 Shown only with Modbus/TCP (Option E)
⇕	<b>DEVICENET MAC ID:</b> 63	Range: 0 to 63 in steps of 1 Shown only with DeviceNet (Option D)
⇕	<b>DEVICENET BAUD RATE:</b> 125 kbps	Range: 125, 250, 500 kbps Shown only with DeviceNet (Option D)
⇕	<b>DEVICENET INPUT POLL DATA:</b> User-Defined	Range: Group 1, Group 2, User-Defined Shown only with DeviceNet (Option D)

⇕	<b>USER-DEFINED DATA</b> <b>SIZE: 110 Registers</b>	Range: 1 to 110 Registers Shown only if DeviceNet Input Poll Data is programmed as User-Defined
	<b>RESET FIELDBUS COMMS INTERFACE: No</b>	Range: No, Yes Only in models with Profibus (Option P or P1), DeviceNet (Option D), or Modbus/TCP (E)

1. RRTD units must be connected in order from RRTD #1 ADDRESS to RRTD #4 ADDRESS. If only one RRTD is used, its slave address must be programmed under RRTD #1 ADDRESS. The next RRTD to be connected would be set up under RRTD #2 ADDRESS, and so forth.
2. Only shown if "FIELDBUS LOSS OF COMMUNICATION" setting is not 'Off'

The 369 is equipped with four independent serial ports. The RS232 port is for local use and responds regardless of the programmed slave address; the rear RS485 communication ports are addressed. If an RRTD module is used in conjunction with the 369, channel 3 must be used for communication between the two devices and the **CHANNEL 3**

**APPLICATION** setpoint must be set to "RRTD" (note that the corresponding RRTD setting must be set to "Modbus"). A fiber optic port (option F) may be ordered for channel 3. If the channel 3 fiber optic port is used, the channel 3 RS485 connection is disabled.

The RS232 port may be connected to a personal computer running EnerVista 369 Setup. This may be used for downloading and uploading setpoints files, viewing actual values, and upgrading the 369 firmware. See Section 4.2: EnerVista 369 Setup Interface on page – 60 for details on using EnerVista 369 Setup.

The RS485 ports support a subset of the Modbus RTU protocol. Each port must have a unique address between 1 and 254. Address 0 is the broadcast address listened to by all relays. Addresses need not be sequential; however, no two devices can have the same address. Generally, each addition to the link uses the next higher address, starting at 1. A maximum of 32 devices can be daisy-chained and connected to a DCS, PLC, or PC using the RS485 ports. A repeater may be used to allow more than 32 relays on a single link.

Either Profibus-DP or Profibus-DPV1 communications are supported with the optional Profibus protocol interface (option P or P1). The bus address of the Profibus-DP/V1 node is set with the **PROFIBUS ADDRESS** setpoint, with an address range from 1 to 126. Address 126 is used only for commissioning purposes and should not be used to exchange user data.

The **RESET FIELDBUS COMMS INTERFACE** setpoint command resets the Fieldbus module. This allows the Fieldbus module to be reset if the Fieldbus module stops communicating with the Fieldbus master, without having to shut down the motor and cycle power to the relay.

The Modbus/TCP protocol is also supported with the optional Modbus/TCP protocol interface (option E). For more information, refer to the *369 Communications Guide*.



After changing or setting the IP address of the relay, please **RESET FIELDBUS COMMS INTERFACE** or cycle the power supply of the 369 in order to make the new IP address active.

The DeviceNet protocol is supported with the optional DeviceNet communication interface (option D), and is certified as ODVA DeviceNet CONFORMANCE TESTED™. The **DEVICENET MAC ID** sets the MAC ID with a range from 0 to 63. The **DEVICENET BAUD RATE** selects a baud rate of 125, 250, or 500 kbps. DeviceNet communications must be stopped before changing DeviceNet setpoints. There will be a delay of 5 to 6 seconds for the new DeviceNet settings to take effect.



Previous to FW v3.30 release, the **FIELD BUS LOSS OF COMMUNICATION** feature was used in the 369 with Profibus Comm. option (P/P1) only and was referred to as “**PROFIBUS LOSS OF COMMUNICATION**”. In FW v3.30 and V3.31 revisions, the **FIELD BUS LOSS OF COMMUNICATION** feature is available for Profibus and Ethernet comm. options.

In FW v3.40 and later revisions, **FIELD BUS LOSS OF COMMUNICATION** feature is available for Profibus, Ethernet and DeviceNet comm. options.

## 5.2.4 Real Time Clock

PATH: S1 369 SETUP ↓↓↓↓↓ REAL TIME CLOCK

REAL TIME CLOCK	ENTER	SET MONTH [1...12]: 09	Range: 1 to 12 in steps of 1
	LINE	SET DAY [1...31]: 01	Range: 1 to 31 in steps of 1
	↕	SET YEAR [1998...2097]:	Range: 1998 to 2097 in steps of 1
	↕	SET HOUR [0...23]: 00	Range: 0 to 23 in steps of 1
	↕	SET MINUTE [0...59]: 00	Range: 0 to 59 in steps of 1
	LINE	SET SECOND [0...59]: 00	Range: 0 to 59 in steps of 1

The time/date stamp is used to track events for diagnostic purposes. The date and time are preset but may be changed manually. A battery backed internal clock runs continuously even when power is off. It has the same accuracy as an electronic watch approximately  $\pm 1$  minute per month. It may be periodically corrected either manually through the keypad or via the clock update command over the serial link using EnerVista 369 Setup.

Enter the current date using two digits for the month and day, and four digits for the year. For example, enter February 28, 2007 as “02 28 2007”. If entered from the keypad, the new date takes effect the moment [ENTER] is pressed. Set the time by using two digits for the hour (in 24 hour time), minutes, and seconds. If entered from the keypad, the new time takes effect the moment the [ENTER] key is pressed.

If the serial communication link is used, then all the relays can keep time in synchronization with each other. A new clock time is pre-loaded into the memory map via the communications port by a remote computer to each relay connected on the communications channel. The computer broadcasts (address 0) a “set clock” command to all relays. Then all relays in the system begin timing at the exact same instant. There can be up to 100 ms of delay in receiving serial commands so the clock time in each relay is  $\pm 100$  ms,  $\pm$  the absolute clock accuracy, in the PLC or PC (see *369 Communications Guide* for information on programming the time and synchronizing commands.)

### 5.2.5 Waveform Capture

PATH: S1 369 SETUP ↓↓↓↓ WAVEFORM CAPTURE

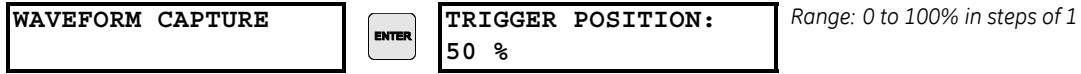

Waveform capture records contain waveforms captured at the sampling rate as well as contextual information at the point of trigger. These records are triggered by trip functions, digital input set to capture or via the EnerVista 369 Setup software. Multiple waveforms are captured simultaneously for each record: Ia, Ib, Ic, Ig, Va, Vb, and Vc.

The trigger position is programmable as a percent of the total buffer size (e.g. 10%, 50%, etc.). The trigger position determines the number of pre- and post-fault cycles to divide the record. The relay sampling rate is 16 samples per cycle.

### 5.2.6 Data Logger

PATH: SETTINGS ↓ S1 369 SETUP ↓↓↓↓

DATA LOGGER	ENTER	<b>START/STOP DATA LOG:</b> Select Command	Range: Select Command, Start, Stop Default: Select Command
	LINE ▼	<b>LOG INTERVAL:</b> 3600 seconds	Range: 1 to 3600 seconds in steps of 1 s. Default: 3600 sec
	⇅	<b>RECORDING TYPE:</b> Run To Fill	Range: Run To Fill, Circulate Default: Run To Fill
	⇅	<b>CHANNEL 1:</b> None	Range: See format below Default: None
	⇅	<b>CHANNEL 2:</b> None	Range: See format below Default: None
	⇅	<b>CHANNEL 3:</b> None	Range: See format below Default: None
	⇅	<b>CHANNEL 4:</b> None	Range: See format below Default: None
	⇅	<b>CHANNEL 5:</b> None	Range: See format below Default: None
	⇅	<b>CHANNEL 6:</b> None	Range: See format below Default: None
	⇅	<b>CHANNEL 7:</b> None	Range: See format below Default: None
	⇅	<b>CHANNEL 8:</b> None	Range: See format below Default: None
	⇅	<b>CHANNEL 9:</b> None	Range: See format below Default: None
	⇅	<b>CHANNEL 10:</b> None	Range: See format below Default: None
	⇅	<b>CHANNEL 11:</b> None	Range: See format below Default: None
	⇅	<b>CHANNEL 12:</b> None	Range: See format below Default: None
	⇅	<b>CHANNEL 13:</b> None	Range: See format below Default: None
	⇅	<b>CHANNEL 14:</b> None	Range: See format below Default: None
	⇅	<b>CHANNEL 15:</b> None	Range: See format below Default: None
	LINE ▲	<b>CHANNEL 16:</b> None	Range: See format below Default: None

**START/STOP DATA LOG:** It is possible to manually start or stop the data logger from the 369 front panel using this setpoint, or by writing to its associated Modbus address (0x1E20). The value, once stored, will be acted upon and the displayed text will revert back to "Select Command". A new Log is started either using this command setpoint (manual), or

by a Motor Start (automatic). A Log will be stopped either using this command setpoint or by a Motor Stop. If, however, the Log was started by command it will not be stopped by a Motor Stop, only by a stop command.

**LOG INTERVAL:** This is the interval at which the data log will store entries. When the Data Logger is started the first record will be immediately recorded. The following records will be stored in increments of the interval time value.

**RECORDING TYPE:** If “Run To Fill” is selected, the Data Logger will stop logging records once the Data Logger data memory area has been filled. If “Circulate” is selected, the Data Logger will continue to log records until stopped, and will overwrite the oldest data stored in the Data Log memory area once 100% has been utilized. In such a case, the Log will act as a rolling window of data in time, going back as far as the maximum number of records that will fit into the total Data Log memory.

**CHANNEL x:** There are up to 16 channels available to capture any of 101 different data parameters available in the 369 relay with each Record. These parameters are described in Modbus format code F189. (Refer to Format Code table in the *369 Communications Guide*).

Please refer to *Data Logger* section in the *369 Communications Guide* for more information on the Data Logger feature.

### 5.2.7 Event Records

PATH: S1 369 SETUP ↓↓↓↓↓↓↓ EVENT RECORDS

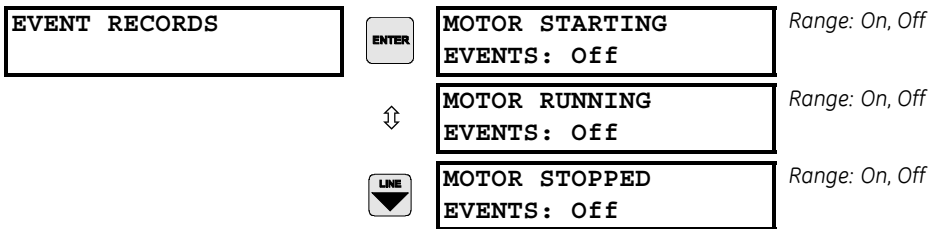

See 6.6.1 *Event Records* on page 6–219 for details on viewing the event recorder.

### 5.2.8 Message Scratchpad

PATH: S1 369 SETUP ↓↓↓↓↓↓↓ MESSAGE SCRATCHPAD

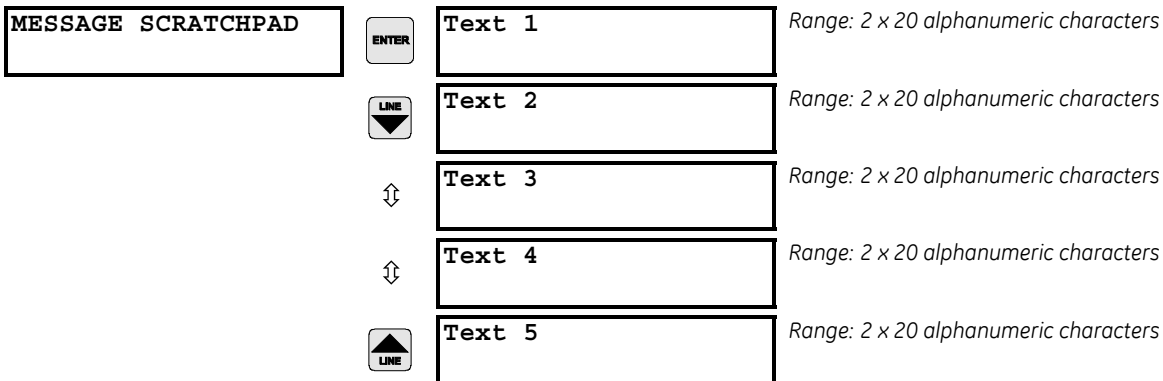

Five 40-character message screens can be programmed. These messages may be notes that pertain to the 369 installation. This can be useful for reminding operators of certain tasks.

### 5.2.9 Default Messages

PATH: S1 369 SETUP ↓↓↓↓↓↓↓↓ DEFAULT MESSAGES

DEFAULT MESSAGES	ENTER	DEFAULT TO CURRENT METERING: No	Range: Yes, No
	LINE ▼	DEFAULT TO MOTOR LOAD: No	Range: Yes, No
	↕	DEFAULT TO DELTA VOLTAGE METERING: No	Range: Yes, No Only shown if option M installed
	↕	DEFAULT TO POWER FACTOR: No	Range: Yes, No Only shown if option M installed
	↕	DEFAULT TO POSITIVE WATTHOURS: No	Range: Yes, No Only shown if option M installed
	↕	DEFAULT TO REAL POWER: No	Range: Yes, No Only shown if option M installed
	↕	DEFAULT TO REACTIVE POWER: No	Range: Yes, No Only shown if option M installed
	↕	DEFAULT TO HOTTEST STATOR RTD: No	Range: Yes, No. Only shown if option R is installed. Indicates stator no. local to 369 only.
	↕	DEFAULT TO TEXT MESSAGE 1: No	Range: Yes, No
	↕	DEFAULT TO TEXT MESSAGE 2: No	Range: Yes, No
	↕	DEFAULT TO TEXT MESSAGE 3: No	Range: Yes, No
	↕	DEFAULT TO TEXT MESSAGE 4: No	Range: Yes, No
	↕	DEFAULT TO TEXT MESSAGE 5: No	Range: Yes, No
	↕	DEFAULT TO HOTTEST STATOR RTD TEMP: No	Range: Yes, No Only shown if option R is installed
	LINE ▲	DEFAULT TO UNBALANCE BIASED MTR LOAD: No	Range: Yes, No. Shown only if unbalance biasing is enabled in the Thermal Model.

The 369 displays a series of default messages. These default messages appear after the value for the **DEFAULT MESSAGE CYCLE TIME** expires and there are no active trips, alarms or start inhibits. See Section 5.2.2: Display Preferences on page –111 for details on setting time delays and message durations. The default messages can be selected from the list above including the five user definable messages from the message scratchpad.

### 5.2.10 Clear/Preset Data

PATH: S1 369 SETUP  $\uparrow\downarrow\uparrow\downarrow\uparrow\downarrow\uparrow\downarrow\uparrow\downarrow$  CLEAR/PRESET DATA

CLEAR/PRESET DATA	ENTER	CLEAR ALL DATA: No	Range: No, Yes
	LINE	CLEAR LAST TRIP DATA: No	Range: No, Yes
	$\updownarrow$	CLEAR TRIP COUNTERS: No	Range: No, Yes
	$\updownarrow$	CLEAR EVENT RECORD: No	Range: No, Yes Clears all 512 events
	$\updownarrow$	CLEAR RTD MAXIMUMS: No	Range: No, Yes
	$\updownarrow$	CLEAR PEAK DEMAND DATA: No	Range: No, Yes
	$\updownarrow$	CLEAR MOTOR DATA: No	Range: No, Yes. Clears learned motor data, last starting current, last starting thermal capacity, last acceleration time, motor statistics, motor start data logger, and data logger
	$\updownarrow$	CLEAR ENERGY DATA: NO	Range: No, Yes Only shown if option M or B are installed.
	$\updownarrow$	PRESET MWh: 0	Range: 0 to 65535 MWh in steps of 1 Can be preset or cleared by storing 0 Only shown if option M or B are installed.
	$\updownarrow$	PRESET POSITIVE Mvarh: 0	Range: 0 to 65535 Mvarh in steps of 1 Can be preset or cleared by storing 0 Only shown if option M or B are installed
	$\updownarrow$	PRESET NEGATIVE Mvarh: 0	Range: 0 to 65535 Mvarh in steps of 1 Can be preset or cleared by storing 0 Only shown if option M or B are installed
	$\updownarrow$	PRESET DIGITAL COUNTER: 0	Range: 0 to 65535 in steps of 1 Can be preset or cleared by storing 0
	$\updownarrow$	PRESET NUMBER OF MOTOR STARTS: 0	Range: 0 to 50000 in steps of 1
	$\updownarrow$	PRESET NUM OF EMERG. RESTARTS: 0	Range: 0 to 50000 in steps of 1
$\updownarrow$	PRESET NUM OF MOTOR RUNNING HOURS: 0	Range: 0 to 65535 in steps of 1	
LINE	PRESET NUM OF AUTO- RESTRT ATPTS: 0	Range: 0 to 50000 in steps of 1	

These commands may be used to clear various historical data. This is useful on new installations or to preset information on existing installations where new equipment has been installed. The **PRESET DIGITAL COUNTER** setpoint appears only if one of the digital inputs has been configured as a digital input counter.

Presetting the energy data is only available for “Mega” units. When these are preset, the corresponding “Kilo” data will be preset to zero.



### 5.2.11 Modify Options

PATH: S1 369 SETUP ↓↓↓↓↓↓↓↓↓↓ MODIFY OPTIONS

MODIFY OPTIONS	ENTER	ENABLE LOCAL RTD? Yes	<i>Range: No, Yes</i>
	LINE ▼	METERING/BACKSPIN: Metering	<i>Range: No, Metering, Backspin</i>
	⇕	ENABLE FIBER OPTIC? No	<i>Range: No, Yes</i>
	⇕	ENABLE ETHERNET? No	<i>Range: No, Yes</i>
	⇕	ENABLE PROFIBUS-DP? No	<i>Range: No, Yes</i>
	⇕	ENABLE PROFIBUS-DPV1? No	<i>Range: No, Yes</i>
	⇕	ENABLE DEVICENET? No	<i>Range: No, Yes</i>
	⇕	ENABLE HARSH ENV.? No	<i>Range: No, Yes</i>
	⇕	ENTER PASSCODE:  	<i>Range: Press the [ENTER] key to begin text editing</i>
	LINE ▲	MODIFY OPTIONS? No	<i>Range: No, Yes</i>

This page allows the user to modify relay options directly from the front keypad.

### 5.2.12 Factory Service

PATH: S1 369 SETUP ↓↓↓↓↓↓↓↓↓↓↓ FACTORY SERVICE

FACTORY SERVICE	ENTER	FACTORY SERVICE PASSCODE: 0	<i>Range: 0 to 65535</i>
-----------------	-------	--------------------------------	--------------------------

This page is for use by GE Multilin personnel for testing and calibration purposes



## 5.3 S2 System Setup

### 5.3.1 Description

The system setup setpoints are critical to the operation of the 369 protective and metering features and elements. Most protective elements are based on the information input for the CT/VT Setup and Output Relay Setup. Additional monitoring alarms and control functions of the relay are also set here.

### 5.3.2 CT/VT Setup

PATH: S2 SYSTEM SETUP ▾ CT/VT SETUP

<b>CT/VT SETUP</b>		<b>PHASE CT PRIMARY:</b> 500	Range: 1 to 5000 in steps of 1
		<b>MOTOR FLA:</b> 10	Range: 1 to 5000 in steps of 1
	⇅	<b>GROUND CT TYPE:</b> 5	Range: None, 5A secondary, 1A secondary, 50:0.025
	⇅	<b>GROUND CT PRIMARY:</b> 100	Range: 1 to 5000 in steps of 1 Only shown for 5A and 1A secondary CT
	⇅	<b>ENABLE 2-SPEED MOTOR PROTECTION:</b> No	Range: Yes, No
	⇅	<b>SPEED2 PHASE CT: PRIMARY<sup>1</sup>:</b> 500 A	Range: 1 to 5000 A in steps of 1
	⇅	<b>SPEED2 MOTOR FLA<sup>1</sup>:</b> 10 A	Range: 1 to 5000 A in steps of 1
	⇅	<b>VT CONNECTION TYPE:</b> None	Range: None, Open Delta, Wye Only shown if option M or B installed
	⇅	<b>VT RATIO:</b> 35:1	Range: 1.00:1 to 240.00:1 Not shown if VT Connection Type set to None
	⇅	<b>MOTOR RATED VOLTAGE:</b> 4160	Range: 100 to 20000 in steps of 1 Not shown if VT Connection Type set to None
	⇅	<b>NOMINAL FREQUENCY:</b> 60 Hz	Range: 50 Hz, 60 Hz, Variable
	⇅	<b>SYSTEM PHASE SEQUENCE:</b> ABC	Range: ABC, ACB
		<b>SPEED2 SYSTEM PHASE SEQUENCE<sup>1</sup>:</b> ABC	Range: ABC, ACB

1. Only shown when "ENABLE 2-SPEED MOTOR PROTECTION" is set to "Yes"

- PHASE CT PRIMARY:** Enter the phase CT primary here. The phase CT secondary (1 A or 5A) is determined by terminal connection to the 369. The phase CT should be chosen such that the motor FLA is between 50% and 100% of the phase CT primary. Ideally the motor FLA should be as close to 100% of phase CT primary as possible, never

more. The phase CT class or type should also be chosen such that the CT can handle the maximum potential fault current with the attached burden without having its output saturate. Information on how to determine this if required is available in Section 7.4: CT Specification and Selection on page –230.

- **MOTOR FLA:** The motor FLA (full load amps or full load current) must be entered. This value may be taken from the motor nameplate or motor data sheets.
- **GROUND CT TYPE and GROUND CT PRIMARY:** The **GROUND CT TYPE** and **GROUND CT PRIMARY** (if 5 A or 1 A secondary) must be entered here. For high resistance grounded systems, sensitive ground detection is possible with the 50:0.025 CT. On solidly or low resistance grounded systems where fault current can be quite high, a 1 A or 5 A CT should be used for either zero-sequence (core balance) or residual ground sensing. If a residual connection is used with the phase CTs, the phase CT primary must also be entered for the ground CT primary. As with the phase CTs the type of ground CT should be chosen to handle all potential fault levels without saturating.
- **ENABLE 2-SPEED MOTOR:** If set to Yes, the following new settings are shown:
  1. **S2 SYSTEM SETUP/ CT/VT SETUP:**  
**SPEED2 PHASE CT**  
**SPEED2 MOTOR FLA**  
**SPEED2 PHASE SEQUENCE**
  2. **S12 TWO SPEED MOTOR:**  
**SPEED2 O/L CURVES**  
**SPEED2 UNDERCURRENT**  
**SPEED2 ACCELERATION**
  3. **S9 DIGITAL INPUTS/ SPEED SWITCH** displays the message **TWO SPEED MONITOR**. The Speed Switch option is added to setting range for:  
**S9 DIGITAL INPUTS/ EMERGENCY RESTART**  
**S9 DIGITAL INPUTS/DIFFERENTIAL SWITCH**  
**S9 DIGITAL INPUTS/REMOTE RESET.**
- **SPEED2 PHASE CT:** This setting specifies the CT primary of the CT used under Speed 2. When in Speed 1, the existing CT primary found under **S2 SYSTEM SETUP/ CT/VT SETUP/PHASE CT PRIMARY** is in effect.
- **SPEED2 MOTOR FLA:** This setting specifies the FLA of the motor running at Speed 2. When in Speed 1, the existing FLA found under **S2 SYSTEM SETUP/ CT/VT SETUP/ MOTOR FLA** is in effect.
- **VT CONNECTION TYPE, VT RATIO, and MOTOR RATED VOLTAGE:** These voltage related setpoints are visible only if the 369 has metering installed.

The manner in which the voltage transformers are connected must be entered here or none if VTs are not used. The VT turns ratio must be chosen such that the secondary voltage of the VTs is between 1 and 240 V when the primary is at motor nameplate voltage. All voltage protection features are programmed as a percent of motor nameplate or rated voltage which represents the rated motor design voltage line to line.

For example: If the motor nameplate voltage is 4160 V and the VTs are 4160/120 open-delta, program **VT CONNECTION TYPE** to “Open Delta”, **VT RATIO** to “34.67:1”, and **MOTOR RATED VOLTAGE** to “4160 V”.

- **NOMINAL FREQUENCY:** Enter the nominal system frequency here.

The 369 has variable frequency functionality when the **NOMINAL FREQUENCY** is set to "Variable". All of the elements function in the same manner with the exception of the voltage and power elements, which work properly if the voltage waveform is approximately sinusoidal. When using a pulse width modulate drive, and an unfiltered voltage waveform is present, the unit will not be able to accurately measure voltage, but an approximately sinusoidal current waveform can be measured accurately. If the **NOMINAL FREQUENCY** is set to "Variable", the filtering algorithm could increase the trip and alarm times for the undervoltage and underfrequency elements by up to 270 ms. If the level exceeds the threshold by a significant amount, trip and alarm times will decrease until they match the programmed delay. The exceptions to this increased time are the short circuit and ground fault elements, which will trip as per specification.

Note that when the **NOMINAL FREQUENCY** setting is "Variable", the element pickup levels and timing are based on the measured values of the 369.

Frequency is normally determined from the Va voltage input. If however this voltage drops below the minimum voltage threshold the Ia current input will be used.

- **SYSTEM PHASE SEQUENCE:** If the phase sequence for a given system is ACB rather than the standard ABC the phase sequence may be changed. This setpoint allows the 369 to properly calculate phase reversal and power quantities.



In motor Forward/Reverse applications, for proper power metering and phase reversal trip protection, the system phase sequence must be set the same as the phase sequence for the forward rotation of the motor.

- **SPEED2 PHASE SEQUENCE:** This setting specifies the phase rotation when running in Speed 2. When in Speed 1, the phase rotation set under **S2 SYSTEM SETUP/ CT/VT SETUP/SYSTEM PHASE SEQUENCE** is in effect.

The FLA rating defines the nominal loading of the motor, and differs depending on motor speed. If **ENABLE 2-SPEED MOTOR** is set to "Yes", and Speed Switch (**TWO SPEED MONITOR**) digital input is detected "closed", the relay automatically applies the **SPEED2 CT PRIMARY** and **SPEED2 FLA** settings to all motor features that previously were configured to utilize the Speed 1 settings: Thermal Model **OVERLOAD PICKUP LEVEL, OVERLOAD ALARM, SHORT CIRCUIT, MECHANICAL JAM, CURRENT UNBALANCE**, and **SPEED2 UNDERCURRENT**. The 369 relay uses one Thermal Model for both speeds, and keeps the accumulated thermal capacity during speed switching. Upon detection of Speed 2, the phase sequence setting under **SYSTEM SETUP/CT/VT SETUP/SPEED2 SYSTEM PHASE SEQUENCE** is used for power metering calculations.

For 2-speed motors rotating in the same direction (typically low/high-speed applications) when in Speed 1 and Speed 2, the settings under **SYSTEM SETUP/CT/VT SETUP/SYSTEM PHASE SEQUENCE** and under **SYSTEM SETUP/CT/VT SETUP/SPEED2 PHASE SEQUENCE** are set the same.

For 2-speed motors changing the rotating direction (motor Forward/Reverse applications), the setting **ABC (ACB)** under **SYSTEM SETUP/CT/VT SETUP/SPEED2 PHASE SEQUENCE** is set to be different than the setting **ACB (ACB)** under **SYSTEM SETUP/CT/VT SETUP/SYSTEM PHASE SEQUENCE**. For these applications, the motor is rotating with the same speed, but is designed and controlled to rotate in both Forward and Reverse directions.

### 5.3.3 Monitoring Setup

#### Main Menu

PATH: S2 SYSTEM SETUP ⇅ MONITORING SETUP

MONITORING SETUP	ENTER	TRIP COUNTER	See below.
	LINE	STARTER FAILURE	See page 5-126
	⇅	LEARNED DATA	See page 5-126
	⇅	CURRENT DEMAND	See page 5-127
	⇅	kW DEMAND <sup>1</sup>	See page 5-127
	⇅	kvar DEMAND <sup>1</sup>	See page 5-127
	⇅	kVA DEMAND <sup>1</sup>	See page 5-127
	LINE	SELF TEST MODE	See page 5-129

1. Only shown if option M or B are installed

#### Trip Counter

PATH: S2 SYSTEM SETUP ⇅ MONITORING SETUP ⇅ TRIP COUNTER

TRIP COUNTER	ENTER	TRIP COUNTER ALARM: Off	Range: Off, Latched, Unlatched
	LINE	ASSIGN ALARM RELAYS: Alarm	Range: None, Alarm, Aux1, Aux2, or combinations of them
	⇅	ALARM PICKUP LEVEL: 25 Trips	Range: 1 to 50000 in steps of 1
	LINE	TRIP COUNTER ALARM EVENTS: Off	Range: On, Off

When the Trip Counter is enabled and the alarm pickup level is reached, an alarm will occur. To reset the alarm the trip counter must be cleared (see Section 5.2.10: Clear/Preset Data on page -120 for details) or the pickup level increased and the reset key pressed (if a latched alarm).

The trip counter alarm can be used to monitor and alarm when a predefined number of trips occur. This would then prompt the operator or supervisor to investigate the causes of the trips that have occurred. Details of individual trip counters can be found in the Motor Statistics section of Actual Values page 4 (see Section 6.5.2: Motor Statistics on page -217).

### Starter Failure

PATH: S2 SYSTEM SETUP ⇓ MONITORING SETUP ⇓ STARTER FAILURE

<b>STARTER FAILURE</b>	ENTER	<b>STARTER FAILURE ALARM: Off</b>	<i>Range: Off, Latched, Unlatched</i>
	LINE ▼	<b>STARTER TYPE: Breaker</b>	<i>Range: Breaker, Contactor</i>
	⇕	<b>ASSIGN ALARM RELAYS: Alarm</b>	<i>Range: None, Alarm, Aux1, Aux2, or combinations of them</i>
	⇕	<b>STARTER FAILURE DELAY: 100 ms</b>	<i>Range: 10 to 1000 ms in steps of 10</i>
	▲ LINE	<b>STARTER FAILURE ALARM EVENTS: Off</b>	<i>Range: On, Off</i>

If the Starter Failure alarm feature is enabled, any time the 369 initiates a trip, the 369 will monitor the Starter Status input (if assigned to “Spare Switch” in **S9 DIGITAL INPUTS**) and the motor current. If the starter status contacts do not change state or motor current does not drop to zero after the programmed time delay, an alarm will occur. The time delay should be slightly longer than the breaker or contactor operating time. In the event that an alarm does occur, and Breaker was chosen as the starter type, the alarm will be Breaker Failure. If on the other hand, Contactor was chosen for starter type, the alarm will be Welded Contactor.

### Learned Data

PATH: S2 SYSTEM SETUP ⇓ MONITORING SETUP ⇓ CURRENT DEMAND

























<b>LEARNED DATA</b>	ENTER	<b>NUMBER OF STARTS TO AVERAGE: 5</b>	<i>Range: 1 to 5 in steps of 1</i>
---------------------	-------	---------------------------------------	------------------------------------

The "Number of Starts to Average" determines how many starts occur before an "average" record-set of data is stored to E<sup>2</sup>PROM.

The "Access Learned Data Record Number" Modbus address is used to determine what data populates the Actual Values display and Modbus addresses from 0x03C0 to 0x03C4, and 0x03C8 to 0x03CA. If the value in this Setpoint is zero, the data reflects the most recent motor start. If the value is anything else, one of the 250 averaged records populates these Actual Values.

### Demand

PATH: S2 SYSTEM SETUP ⇅ MONITORING SETUP ⇅⇅ CURRENT DEMAND

CURRENT DEMAND  		CURRENT DEMAND PERIOD: 15 min	Range: 5 to 90 min in steps of 1
		CURRENT DEMAND ALARM: Off	Range: Off, Latched, Unlatched
		ASSIGN ALARM RELAYS: Alarm	Range: None, Alarm, Aux1, Aux2, or combinations of them
		CURRENT DEMAND ALARM LIMIT: 100 A	Range: 0 to 65000 A in steps of 1
		CURRENT DEMAND ALARM EVENTS: Off	Range: On, Off
kW DEMAND <sup>1</sup>  		kW DEMAND PERIOD: 15 min	Range: 5 to 90 min in steps of 1
		kW DEMAND ALARM: Off	Range: Off, Latched, Unlatched
		ASSIGN ALARM RELAYS: Alarm	Range: None, Alarm, Aux1, Aux2, or combinations of them
		kW DEMAND ALARM LIMIT: 100 kW	Range: 1 to 50000 kW in steps of 1
		kW DEMAND ALARM EVENTS: Off	Range: On, Off
kvar DEMAND <sup>1</sup>  		kvar DEMAND PERIOD: 15 min	Range: 5 to 90 min. in steps of 1
		kvar DEMAND ALARM: Off	Range: Off, Latched, Unlatched
		ASSIGN ALARM RELAYS: Alarm	Range: None, Alarm, Aux1, Aux2, or combinations of them
		kvar DEMAND ALARM LIMIT: 100 kvar	Range: 1 to 50000 kvar in steps of 1
		kvar DEMAND ALARM EVENTS: Off	Range: On, Off
kVA DEMAND <sup>1</sup>  		kVA DEMAND PERIOD: 15 min	Range: 5 to 90 min in steps of 1
		kVA DEMAND ALARM: Off	Range: Off, Latched, Unlatched
		ASSIGN ALARM RELAYS: Alarm	Range: None, Alarm, Aux1, Aux2, or combinations of them
		kVA DEMAND ALARM LIMIT: 100 kVA	Range: 1 to 50000 kVA in steps of 1
		kVA DEMAND ALARM EVENTS: Off	Range: On, Off

1. Only shown if option M or B are installed

The 369 can measure the demand of the motor for several parameters (current, kW, kvar, kVA). The demand values may be of interest for energy management programs where processes may be altered or scheduled to reduce overall demand on a feeder. An alarm will occur if the limit of any of the enabled demand elements is reached.

Demand is calculated in the following manner. Every minute, an average magnitude is calculated for current, +kW, +kvar, and kVA based on samples taken every 5 seconds. These values are stored in a FIFO (First In, First Out) buffer. The size of the buffer is determined by the period selected for the setpoint. The average value of the buffer contents is calculated and stored as the new demand value every minute. Demand for real and reactive power is only positive quantities (+kW and +kvar).

$$\text{DEMAND} = \frac{1}{N} \sum_{n=1}^N |\text{Average}(n)| \quad (\text{EQ 0.1})$$

where:  $N$  = programmed demand period in minutes and  $n$  = time in minutes.

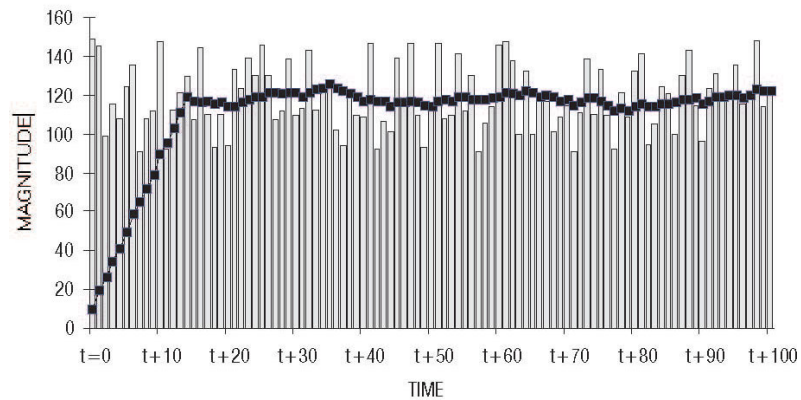

FIGURE 5-1: Rolling demand (15 minute window)



### Self-Test Relay Assignment

PATH: S2 SYSTEM SETUP ↕↕ MONITORING SETUP ↕↕↕↕↕↕ SELF TEST MODE

SELF TEST MODE	ENTER	ASSIGN SERVICE RELAY:	Range: None, Alarm, Aux1, Aux2, or combinations of these
----------------	-------	-----------------------	--

The 369 performs self-diagnostics of the circuitry. The relay programmed as the Self-Test relay activates upon a failure of any self-diagnostic tests.

### 5.3.4 Block Functions

PATH: S2 SYSTEM SETUP ↕↕↕ BLOCK FUNCTIONS

BLOCK FUNCTIONS	ENTER	LOG BLOCKING EVENTS: Disabled	Range: Enabled, Disabled
	LINE ▼	BLOCK UC/UPWR (37) Not Blocked	Block Undercurrent and Underpower Range: Blocked, Not Blocked
	↕	BLOCK CURR UNBAL (46)	Block Current Unbalance Range: Blocked, Not Blocked
	↕	BLOCK INC SEQ (48) Not Blocked	Block Incomplete Sequence Range: Blocked, Not Blocked
	↕	BLOCK THERM MOD (49) Not Blocked	Block Thermal Model Range: Blocked, Not Blocked
	↕	BLOCK SHORT CCT (50) Not Blocked	Block Short Circuit and Backup Range: Blocked, Not Blocked
	↕	BLOCK O/L ALARM (51) Not Blocked	Block Overload Alarm Range: Blocked, Not Blocked
	↕	BLOCK GND FLT (51G) Not Blocked	Block Ground Fault Range: Blocked, Not Blocked
	LINE ▲	BLOCK STARTS/HR (66) Not Blocked	Block Starts Per Hour and Time Between Starts Range: Blocked, Not Blocked

The block functions feature allows the user to block any of the protection functions through the following methods:

1. Modbus command 20.
2. Profibus-DPV1 acyclical communication (refer to Chapter 9 for additional details).
3. Modbus setpoints.
4. The front panel interface.

The protection functions that can be blocked are indicated by ANSI/IEEE device number in the table below.

DEVICE	DESCRIPTION
37	Undercurrent/underpower
46	Current unbalance
48	Incomplete sequence

DEVICE	DESCRIPTION
49	Thermal model
50	Short circuit and backup
51	Overload alarm
51G	Ground fault
66	Starts per hour / time between starts

Blocking a protection function is essentially the same as disabling it. If the protection function is blocked and a situation occurs where it would have been activated (if enabled), no indication will be given and no events are recorded. If the protection function has picked up and/or is timing out, the internal timers will be reset to zero.

If the **LOG BLOCKING EVENTS** setpoint is enabled, an event will be stored indicating when a function changes from being blocked to unblocked, or vice versa.

### 5.3.5 Output Relay Setup

PATH: S2 SYSTEM SETUP ↓↓↓↓ OUTPUT RELAY SETUP

<b>OUTPUT RELAY SETUP</b>	ENTER	<b>TRIP RELAY RESET</b> MODE: All Resets	Range: All Resets, Remote Only, Local Only
	LINE ▼	<b>TRIP RELAY</b> OPERATION: FS	Range: FS (=failsafe), NFS (=non-failsafe)
	⇅	<b>TRIP RELAY</b> SEAL-IN: None	Range: None, Starters Status Input Only seen if setpoint SPARE SW FUNCTION is "Starter Status"
	⇅	<b>AUX1 RELAY RESET</b> MODE: All Resets	Range: All Resets, Remote Only, Local Only
	⇅	<b>AUX1 RELAY</b> OPERATION: NFS	Range: FS (=failsafe), NFS (=non-failsafe)
	⇅	<b>AUX2 RELAY RESET</b> MODE: All Resets	Range: All Resets, Remote Only, Local Only
	⇅	<b>AUX2 RELAY</b> OPERATION: NFS	Range: FS (=failsafe), NFS (=non-failsafe)
	⇅	<b>ALARM RELAY RESET</b> MODE: All Resets	Range: All Resets, Remote Only, Local Only
LINE ▲	<b>ALARM RELAY</b> OPERATION: NFS	Range: FS (failsafe), NFS (=non-failsafe)	

A latched relay (caused by a protective elements alarm or trip) may be reset at any time, providing that the condition that caused the relay operation is no longer present. Unlatched elements will automatically reset when the condition that caused them has cleared. Reset location is defined in the following table.

RESET MODE	RESET PERFORMED VIA
All Resets	keypad, digital input, communications
Remote Only	digital input, communications
Local Only	keypad

The **TRIP OPERATION**, **AUX1 OPERATION**, **AUX2 OPERATION**, and **ALARM OPERATION** setpoints allow the choice of relay output operation to fail-safe or non-failsafe. Relay latchcode however, is defined individually for each protective element.

Failsafe operation causes the output relay to be energized in its normal state and de-energized when activated by a protection element. A failsafe relay will also change state (if not already activated by a protection element) when control power is removed from the 369. Conversely a non-failsafe relay is de-energized in its normal non-activated state and will not change state when control power is removed from the 369 (if not already activated by a protection element).

The choice of failsafe or non-failsafe operation is usually determined by the motor’s application. In situations where the process is more critical than the motor, non-failsafe operation is typically programmed. In situations where the motor is more critical than the process, failsafe operation is programmed.

**TRIP RELAY SEAL-IN:** If the setpoint is set to “Starter Status”, the trip contact will remain at the trip state (The fail-safe **NO** contact opens; the non-fail-safe **NO** contact closes) unless the starter status is open and the trip initiating condition has reset, or the 369 is manually reset. The feature can protect damage to trip relay contact in a breaker failure condition. The starter status is derived from the digital input **SPARE SWITCH**, and the setpoint **SPARE SW FUNCTION** in **S9 DIGITAL INPUTS** must be set to “Starter Status” before enabling the feature.



Emergency Restart will ALWAYS reset the 369 regardless of the reset mode setting.



Latched trips and alarms are not retained after control power is removed from the 369.

### 5.3.6 Control Functions

#### Main Menu

PATH: S2 SYSTEM SETUP ↓↓↓↓ CONTROL FUNCTIONS

CONTROL FUNCTIONS	ENTER	SERIAL COMMUNICATION CONTROL	See below.
	LINE ▼	REDUCED VOLTAGE	See page 5-132
	↕	AUORESTART	See page 5-134
	↕	UNDERVOLTAGE AUORESTART <sup>1</sup>	See page 5-137
	▲ LINE	FORCE OUTPUT RELAYS	See page 5-139

1. Only shown if option M or B are installed.

### Serial Communication Control

PATH: S2 SYSTEM SETUP ↓↓↓↓ CONTROL FUNCTIONS ↓ SERIAL COMMUNICATION CONTROL

SERIAL COMMUNICATION CONTROL	ENTER	SERIAL COM CONTROL CONTROL - Off	Range: On, Off
	LINE	ASSIGN START CONTROL RELAYS: Aux1	Range: None, Alarm, Aux1, Aux2 or combinations of them

If enabled, the motor can be remotely started and stopped via Modbus® communications. Refer to the Modbus Protocol Reference Guide (available from the Modbus website at <http://www.modbus.org>) for details on sending commands (Function Code 5). When a Stop command is sent the Trip relay will activate for 1 second to complete the trip coil circuit for a breaker application or break the coil circuit for a contactor application. When a Start command is issued the relay assigned for starting control will activate for 1 second to complete the close coil circuit for a breaker application or complete the coil circuit for a contactor application.

The Serial Communication Control functions can also be used to reset the relay and activate a waveform capture. Refer to the Modbus Protocol Reference Guide (available from the Modbus website at <http://www.modbus.org>) for more information.

### Reduced Voltage Start Timer

PATH: S2 SYSTEM SETUP ↓↓↓↓ CONTROL FUNCTIONS ↓↓ REDUCED VOLTAGE

REDUCED VOLTAGE	ENTER	REDUCED VOLTAGE CONTROL: Off	Range: On, Off
	LINE	ASSIGN START CONTROL RELAYS: None	Range: None, Alarm, Aux1, Aux2, Alarm & Aux1, Alarm & Aux2, Aux1 & Aux2, Alarm & Aux1 & Aux2
	↕	START CONTROL RELAY TIMER: 1.0 s	Range: 1.0 to 10.0 s in steps of 0.5
	↕	TRANSITION ON: Current Only	Range: Current Only, Current or Timer, Current and Timer
	↕	REDUCED VOLTAGE START LEVEL: 100%FLA	Range: 25 to 300% FLA in steps of 1
	↕	REDUCED VOLTAGE START TIMER: 200 s	Range: 1 to 500 s in steps of 1
	LINE	ASSIGN TRIP RELAYS: Trip	Range: None, Trip, Aux1, Aux2, Trip & Aux1, Trip & Aux2, Aux1 & Aux2, Trip & Aux1&Aux2

The 369 is capable of controlling the transition of a reduced voltage starter from reduced to full voltage. That transition may be based on “Current Only”, “Current and Timer”, Or “Current or Timer” (whichever comes first). When the 369 measures the transition of no motor current to some value of motor current, a 'Start' is assumed to be occurring (typically current will rise quickly to a value in excess of FLA, e.g. 3 x FLA). At this point, the **REDUCED VOLTAGE START TIMER** will be initialized with the programmed value in seconds.

- If "Current Only" is selected, when the motor current falls below the programmed Transition Level, transition will be initiated by activating the assigned output relay for the time programmed in the **START CONTROL RELAY TIMER** setpoint. If the timer

expires before that transition is initiated, an Incomplete Sequence Trip will occur activating the assigned trip relay(s).

- If "Current or Timer" is selected, when the motor current falls below the programmed Transition Level, transition will be initiated by activating the assigned output relay for the time programmed in the **START CONTROL RELAY TIMER** setpoint. If the timer expires before that transition is initiated, the transition will be initiated regardless.
- If "Current and Timer" is selected, when the motor current falls below the programmed Transition Level and the timer expires, transition will be initiated by activating the assigned output relay for the time programmed in the **START CONTROL RELAY TIMER** setpoint. If the timer expires before current falls below the Transition Level, an Incomplete Sequence Trip will occur activating the assigned trip relay(s).

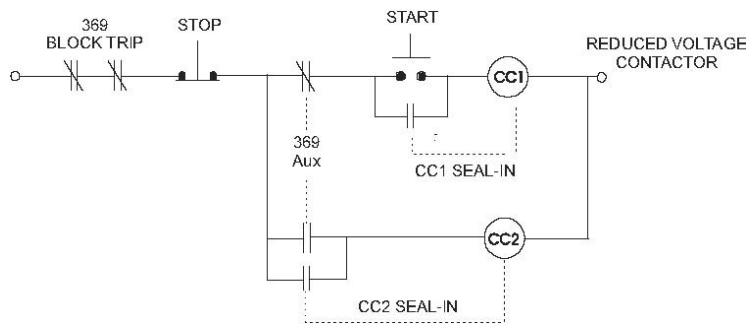

FIGURE 5-2: Reduced Voltage Start Contactor Control Circuit

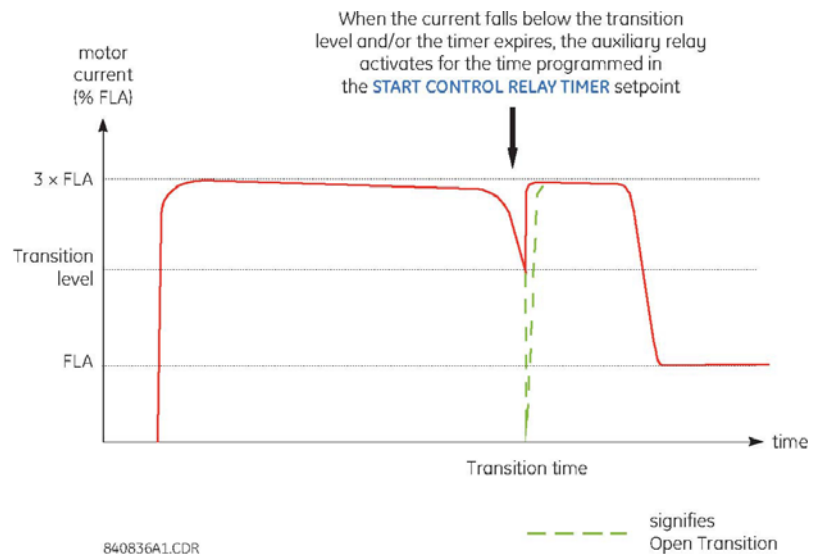

FIGURE 5-3: Reduced Voltage Starting Current Characteristic



If this feature is used, the Starter Status Switch input must be either from a common control contact or a parallel combination of Auxiliary 'a' contacts or a series combination of Auxiliary 'b' contacts from the reduced voltage contactor and the full voltage contactor.

Once transition is initiated, the 369 will assume the motor is still running for at least 2 seconds. This will prevent the 369 from recognizing an additional start if motor current goes to zero during an open transition.

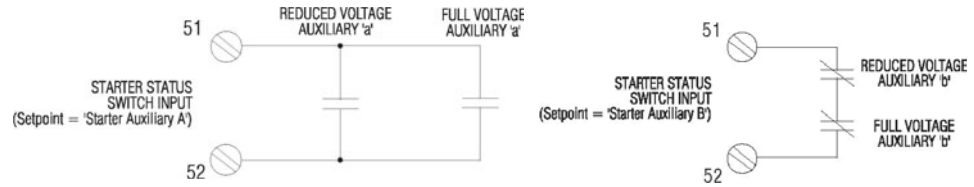

FIGURE 5-4: Reduced Voltage Starter Auxiliary A/B Status Inputs

**Autorestart**

PATH: S2 SYSTEM SETUP ↓↓↓↓ CONTROL FUNCTIONS ↓↓↓ AUTORESTART

AUTORESTART	ENTER	AUTORESTART ENABLED: No	Range: Yes, No
	LINE ▼	TOTAL RESTARTS: 1	Range: 0 to 65000 in steps of 1
	↕	RESTART DELAY: 0 s	Range: 0 to 20000 s in steps of 1
	↕	PROGRESSIVE DELAY: 0 s	Range: 0 to 20000 s in steps of 1
	↕	HOLD DELAY: 0 s	Range: 0 to 20000 s in steps of 1
	↕	BUS VALID ENABLED <sup>1</sup> : No	Range: Yes, No
	↕	BUS VALID LEVEL <sup>1</sup> : 100%	Range: 15 to 100% of Motor Rated Voltage in steps of 1
	↕	AUTORESTART ATTEMPT EVENTS: Off	Range: On, Off
	↕	AUTORESTART SUCCESS EVENTS: Off	Range: On, Off
	LINE ▲	AUTORESTART ABORTED EVENTS: Off	Range: On, Off

1. Only shown if option M or B are installed

The 369 can be configured to automatically restart the motor after it tripped on system or process related disturbances, such as an undervoltage or an overload. This feature is useful in remote unmanned pumping applications. Before using autorestart, the feature must be enabled, the required restart time after a trip programmed, and an output contact configured to initiate the autorestart by closing the circuit breaker or contactor. This output contact can also be wired with OR logic in the start circuit of the motor.

To prevent the possibility of closing onto a fault upon autorestarting, this feature is not allowed for all trips. The 369 never attempts an autorestart after Short Circuit or Ground Fault trips. Furthermore, only one autorestart is attempted after an Overload trip, provided

that Single Shot Restart is enabled, which allows a single restart attempt. The thermal capacity is cleared to prevent another overload trip during this start and if the 369 trips again (second time) on Overload the autorestarting is aborted. Any normal manual starting will probably be inhibited, (lockout time) allowing the motor to cool (thermal capacity to decay) before permitting another start.

The trip relay should reset before closing the auto-restart contact to allow the breaker or contactor to close. This is done by programming **S2 SYSTEM SETUP** ⇒ **OUTPUT RELAY SETUP** ⇒ **TRIP RESET MODE** to “Remote Only” or “All Resets”. The close contact selection is enabled by setting the **S2 SYSTEM SETUP** ⇒ **CONTROL FUNCTIONS** ⇒ **SERIAL COMMUNICATION CONTROL** ⇒ **SERIAL COMMUNICATION CONTROL** setpoint to “On” and selecting the desired output contact.

The 369 follows the logic shown in FIGURE 5-5: *AUTORESTART LOGIC* on page 5-136 to determine restart conditions. The total autorestart delay comprises the sum of three delays: Restart Delay, Progressive Delay, and Hold Delay. If any of these are not required, the autorestart delay can be set to zero.

$$\text{Total Delay} = \text{Restart Delay} + (\text{auto-restarts number} \times \text{Progressive Delay}) + \text{Hold Delay}$$

The Restart Delay controls the basic auto-restart time and the timer start when the motor tripped. The Progressive Delay increases each consecutive auto-restart delay with its set amount. For example, assume that Restart Delay, Progressive Delay, and Hold Delay are 1, 3, and 0 seconds respectively. Therefore the fifth autorestart waiting time is:

$$1 \text{ sec.} + 5\text{th auto-restart} \times 3 \text{ sec.} + 0 \text{ sec.} = 1 \text{ sec.} + 5 \times 3 \text{ sec.} = 16 \text{ sec.}$$

The number of autorestarts is limited by the **TOTAL RESTARTS** setting to a maximum of 65000. Once this is exceeded, the 369 blocks further autorestarts until it is reset, either manually or remotely. This limit does not affect normal starting. Please note that 65000 autorestarts implies the motor has been tripped that many times and inspection or maintenance is probably due. The vendor’s suggested number of circuit breaker or contactor operations before maintenance can affect this setting.

The Hold Delay sequentially staggers auto-restarts for multiple motors on a bus. For example, if four motors on a bus have settings of 60, 120, 180, and 240 seconds, respectively, it is advantageous, after a common fault that trips all four motors, to autorestart at 60 second intervals to minimize voltage sag and overloading

The presence of healthy bus voltage prior to the auto-restart can be verified by enabling the Bus Valid feature. The **BUS VALID LEVEL** setting is the voltage level below which autorestart is not to be attempted. The 369 checks the **BUS VALID LEVEL** just before the autorestart to allow the bus voltage to recover. This setpoint is only available if the Metering Option (M) or Backspin Option (B) is enabled.

Five different types of “Autorestart Aborted” events have been provided to help in troubleshooting. The following flowchart shows the logic flow of the Autorestart algorithm. Each type of Autorestart Aborted event and where it occurs within the logic flow is indicated in this diagram. For example, if an “Autorestart Aborted1” event is recorded in the event recorder, the logic diagram immediately indicates that the abort cause was the number of restart attempts being more than the **MAXIMUM NUMBER OF RESTARTS** setpoint.

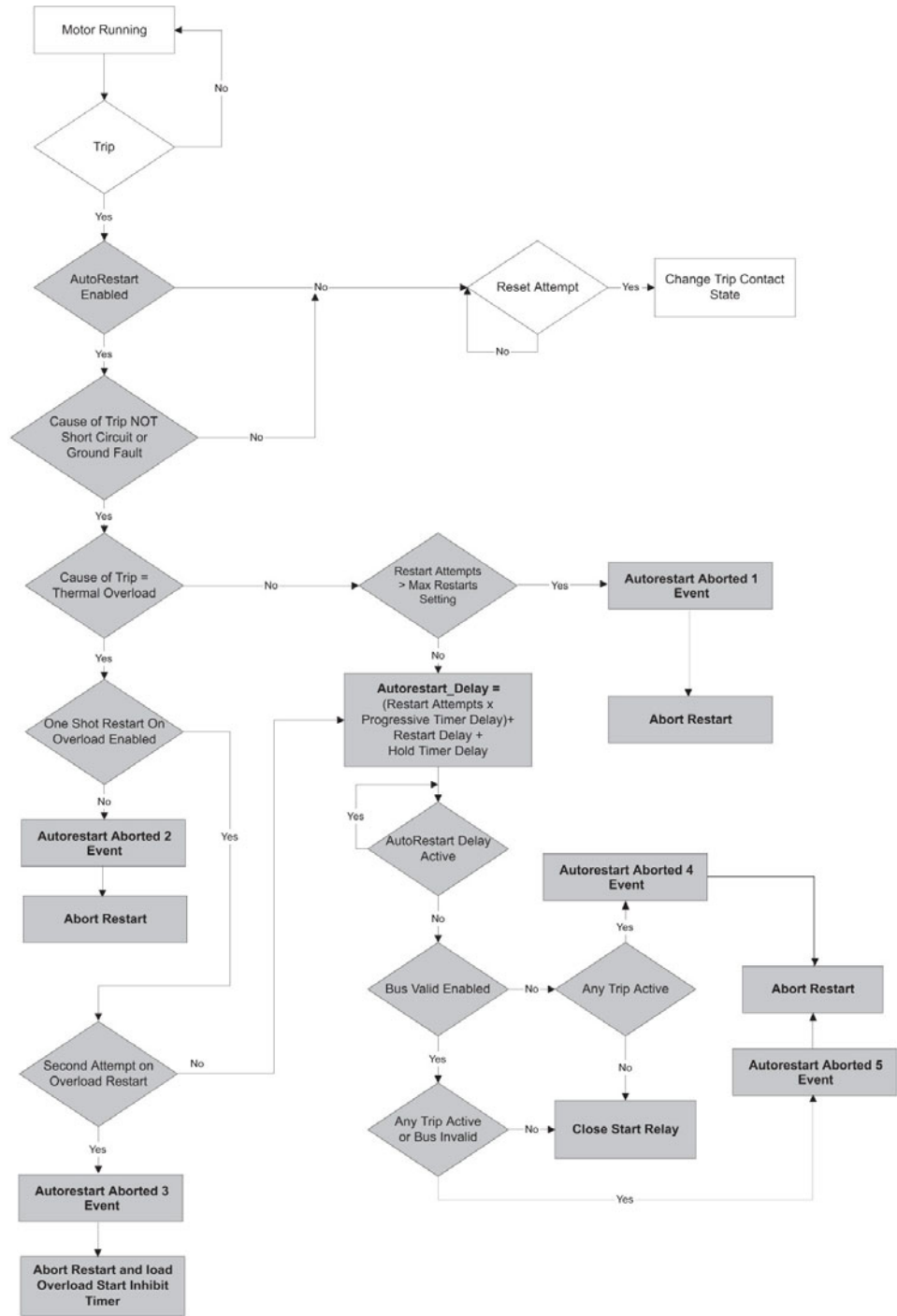



FIGURE 5-5: AUTORESTART LOGIC



## Undervoltage Autorestart

PATH: S2 SYSTEM SETUP ▾▾▾▾▾ CONTROL FUNCTIONS ▾▾▾ UNDERVOLTAGE  
AUTORESTART

<div style="border: 1px solid black; padding: 2px; width: fit-content;">UNDERVOLTAGE AUTORESTART<sup>1</sup></div>	ENTER	<b>ENABLE UVR:</b> On	Range: Off, On (Default: Off)
	⇅	<b>UVR PICKUP LEVEL:</b> 0.65 x Rated	Range: 0.5 to 1.0 x RATED in steps of 0.01 (Default 0.65 X RATED) Note: Must be set lower than the UVR Restoration Level
	⇅	<b>UVR ASSIGN TRIP RELAYS:</b> None	Range: None, Trip, Aux1, Aux2 or combinations (Default: None)
	⇅	<b>UVR TRIP DELAY:</b> 0.0 seconds	Range: 0 to 255 s in steps of 0.1 s (Default: 0)
	⇅	<b>UVR RESTORATION LEVEL:</b> 0.90 x Rated	Range: 0.5 to 1.0 x RATED in steps of 0.01 (Default: 0.90 X RATED) Note: Must be set higher than the UVR Pickup Level
	⇅	<b>IMMED RESTART POWER LOSS TIME:</b> 200 ms	Range: 100 to 500 ms or Off in steps of 100 ms (Default: Off)
	⇅	<b>DELAY1 RESTART POWER LOSS TIME:</b> 2.0 s	Range: 0.1 to 10 s or Off in steps of 0.1 s (Default: Off) 0 = Off
	⇅	<b>DELAY2 RESTART POWER LOSS TIME:</b> Off	Range: 1 to 3600 s or Unlimited, Off in steps of 1 s (Default: Off) 0 = Off, 3601 = Unlimited
	⇅	<b>DELAY1 RESTART TIME DELAY:</b> 2.0 s	Range: 0 to 1200 s in steps of 0.2 s (Default: 2.0 s)
	⇅	<b>DELAY2 RESTART TIME DELAY:</b> 10.0 s	Range: 0 to 1200 s in steps of 0.2 s (Default: 10.0 s)
	<b>UVR SETUP TIME:</b> 10.0 seconds	Range: 0 to 1200 s in steps of 0.2 s (Default: 10.0 s)	

1. Only shown if option M or B are installed

This feature is only available if the Metering option (M) or Backspin option (B) is present, and the setpoint **VT CONNECTION TYPE** is set to something other than "None".

**ENABLE UNDERVOLTAGE AUTORESTART** It is possible to restart the motor after a momentary power loss (dip) if this feature is enabled. When the magnitude of either of Vab, Vbc, or Vca drops below the setpoint **UVR PICKUP LEVEL**, the motor contactor(s) are de-energized. The duration of the power loss is classified as Immediate restart power loss, delay 1 restart power loss and delay 2 restart power loss based on settable time thresholds. The motor contactor or breaker can be tripped by the 369 if the setpoint **UVR ASSIGN TRIP RELAYS** is set a contact output other than "None", and the assigned contact output is wired to the trip circuit.

If the power is restored as indicated by the magnitudes of Vab, Vbc, or Vca all recover above the setpoint **UVR RESTORATION LEVEL** within the **IMMED. RESTART POWER LOSS TIME**, the motor will be restarted immediately. If the power is restored after the **IMMED. RESTART POWER LOSS TIME** but before the **DELAY 1 RESTART POWER LOSS TIME** or **DELAY 2 RESTART POWER LOSS TIME**, the motor will be restarted after the **DELAY 1 RESTART TIME DELAY** or **DELAY 2 RESTART TIME DELAY**. If a delayed restart is always required, set the **DELAY 2 RESTART POWER LOSS TIME** to

**UNLIMITED.** If another power loss occurs during the **DELAY 1 RESTART TIME DELAY** or **DELAY 2 RESTART TIME DELAY**, all the autorestart timers will be reset and the autorestart element will be re-initiated based on the latest power loss.

If this feature is used, the Spare Switch must be used as a Starter Status Switch input reflecting the state of the main contactor or breaker.

The trip relay should reset before closing the autorestart contact to allow the breaker or contactor to close. This is done by programming **S2 SYSTEM SETUP - OUPUT RELAY SETUP - TRIP RESET MODE** to "Remote Only" or "All Resets". The element uses an output contact to initiate the autorestart by closing the circuit breaker or contactor. This output contact can be wired with OR logic in the start circuit of the motor. The close contact selection is enabled by setting the setpoint **S2 SYSTEM SETUP - CONTROL FUNCTIONS - SERIAL COMMUNICATION CONTROL - SERIAL COMMUNICATION CONTROL** to "On" and selecting the desired output contact for the setpoint **ASSIGN START CONTROL RELAYS**.

The difference between the undervoltage autorestart with the **SYSTEM SETUP – CONTROL FUNCTIONS – AUTORESTART** element: The undervoltage restart is blocked by any trip issued by 369 except undervoltage element, and if the undervoltage restart is enabled, the **SYSTEM SETUP – CONTROL FUNCTIONS – AUTORESTART** can't be activated by undervoltage element. It means that if the undervoltage autorestart is enabled, the undervoltage autorestart element covers no trip condition and under voltage trip condition, the **SYSTEM SETUP – CONTROL FUNCTIONS – AUTORESTART** covers all the trip condition except undervoltage condition.

**UVR PICKUP LEVEL** sets the motor voltage level below which the undervoltage autorestart element is triggered. Must be set lower than **UVR RESTORATION LEVEL**.

**UVR ASSIGN TRIP RELAYS** assign the trip relay to open the contactor or breaker when a power loss is detected and the duration is longer than the setpoint **UVR TRIP DELAY**. None disables the UVR trip output.

**UVR TRIP DELAY** sets the time delay to trip the breaker or contactor.

**UVR RESTORATION LEVEL** sets the motor voltage level above which the undervoltage autorestart element restarts. Must be set higher than **UVR PICKUP LEVEL**.

**IMMED. RESTART POWER LOSS TIME** sets the immediate autorestart power loss duration, which result in immediate restart. Off disables immediate restart.

**DELAY 1 RESTART POWER LOSS TIME Off** disables the delay 1 undervoltage autorestart.

**DELAY 2 RESTART POWER LOSS TIME** sets to **UNLIMITED** if a delayed restart is always required. Off disables the delay 2 undervoltage autorestart.

**UVR SETUP TIME** sets the amount of time the voltages must be healthy before a another immediate restart is to be attempted.



The Undervoltage Autorestart feature is intended for use in applications where the 369 is powered from an uninterruptible power supply, separate from the AC mains powering the motor. For applications where the 369 is supplied from the same AC mains as the motor, the timing specification for restarting the motor is  $\pm 9$  seconds. Care must be taken when coordinating process start-up.

## Force Output Relays

PATH: S2 SYSTEM SETUP ↓↓↓↓↓ CONTROL FUNCTIONS ↓↓↓↓ FORCE OUTPUT RELAYS

FORCE OUTPUT RELAYS	
ENTER	ASSIGN COMMS FORCE RELAYS: None <i>Range: None, Trip, Alarm, Aux1, Aux2, or combinations of these.</i>
LINE	TRIP COM FORCE O/P TYPE: Latched <i>Range: Latched, Pulsed</i>
↕	TRIP PULSED OP DWELL TIME: 0.5 s <i>Range: 0.5 to 5000.0 s in steps of 0.1. Only seen if the TRIP COM FORCE O/P TYPE is "Pulsed".</i>
↕	ALARM COM FORCE O/P TYPE: Latched <i>Range: Latched, Pulsed</i>
↕	ALARM PULSED OP DWELL <i>Range: 0.5 to 5000.0 s in steps of 0.1. Only seen if the ALARM COM FORCE O/P TYPE is</i>
↕	AUX1 COM FORCE O/P TYPE: Latched <i>Range: Latched, Pulsed</i>
↕	AUX1 PULSED OP DWELL TIME: 0.5 s <i>Range: 0.5 to 5000.0 s in steps of 0.1. Only seen if the AUX1 COM FORCE O/P TYPE is "Pulsed".</i>
↕	AUX2 COM FORCE O/P TYPE: Latched <i>Range: Latched, Pulsed</i>
LINE	AUX2 PULSED OP DWELL TIME: 0.5 s <i>Range: 0.5 to 5000.0 s in steps of 0.1. Only seen if the AUX2 COM FORCE O/P TYPE is "Pulsed".</i>

The force output relays function allows the user to energize and de-energize output relays via remote communications (Modbus or Profibus-DVP1).

To allow the forcing of relay states, the **ASSIGN COMMS FORCE RELAY** setting must be programmed. Only relays assigned under this setpoint can be forced through Modbus or Profibus-DVP1 communications.

Commands can be sent to energize or de-energize any of the four output relays. A bit value of "1" for the corresponding relay will energize that relay; a bit value of "0" will de-energize that relay.

The **COM FORCE O/P TYPE** setting for each relay determines whether it remains latched in the state sent through the command, or whether it operates for a duration programmed in the associated **PULSED OP DWELL TIME** setting. If **COM FORCE O/P TYPE** is "Latched", the relay remains energized until a value of "0" for the relay has been sent through the command. If **COM FORCE O/P TYPE** is "Pulsed" and a command is sent to energize the output relay while a pulse dwell timer from a previous command has not yet timed to zero, then the timer will reset back to the value of the corresponding **PULSED OP DWELL TIME** setpoint and start counting down from this value.

If a relay state is programmed as "Latched" and forced through the force output relays function, the only way to de-energize it is through another serial command or by cycling power to the 369.



For safety reasons, if any of the relays in the **S11 TESTING** ↓ **TEST OUTPUT RELAYS** section are programmed to any value other than “Disabled” (i.e. energized or de-energized), then the force relays functionality through Modbus and Profibus-DPV1 will be disabled.

---

## 5.4 S3 Overload Protection

### 5.4.1 Description

Heat is one of the principle enemies of motor life. When a motor is specified, the purchaser communicates to the manufacturer what the loading conditions, duty cycle, environment and pertinent information about the driven load such as starting torque. The manufacturer then provides a stock motor or builds a motor that should have a reasonable life under those conditions. The purchaser should request all safe stall, acceleration and running thermal limits for all motors they receive in order to effectively program the 369.

Motor thermal limits are dictated by the design of the stator and the rotor. Motors have three modes of operation: locked rotor or stall (rotor is not turning), acceleration (rotor is coming up to speed), and running (rotor turns at near synchronous speed). Heating occurs in the motor during each of these conditions in very distinct ways. Typically, during motor starting, locked rotor, and acceleration conditions, the motor is rotor limited. That is, the rotor approaches its thermal limit before the stator. Under locked rotor conditions, voltage is induced in the rotor at line frequency, 50 or 60 Hz. This voltage causes a current to flow in the rotor, also at line frequency, and the heat generated ( $I^2R$ ) is a function of the effective rotor resistance. At 50/60 Hz, the rotor cage reactance causes the current to flow at the outer edges of the rotor bars. The effective resistance of the rotor is therefore at a maximum during a locked rotor condition as is rotor heating. When the motor is running at rated speed, the voltage induced in the rotor is at a low frequency (approximately 1 Hz) and therefore, the effective resistance of the rotor is reduced quite dramatically. During running overloads, the motor thermal limit is typically dictated by stator parameters. Some special motors might be all stator or all rotor limited. During acceleration, the dynamic nature of the motor slip dictates that rotor impedance is also dynamic, and a third overload thermal limit characteristic is necessary.

Typical thermal limit curves are shown below. The motor starting characteristic is shown for a high inertia load at 80% voltage. If the motor started quicker, the distinct characteristics of the thermal limit curves would not be required and the running overload curve would be joined with locked rotor safe stall times to produce a single overload curve.

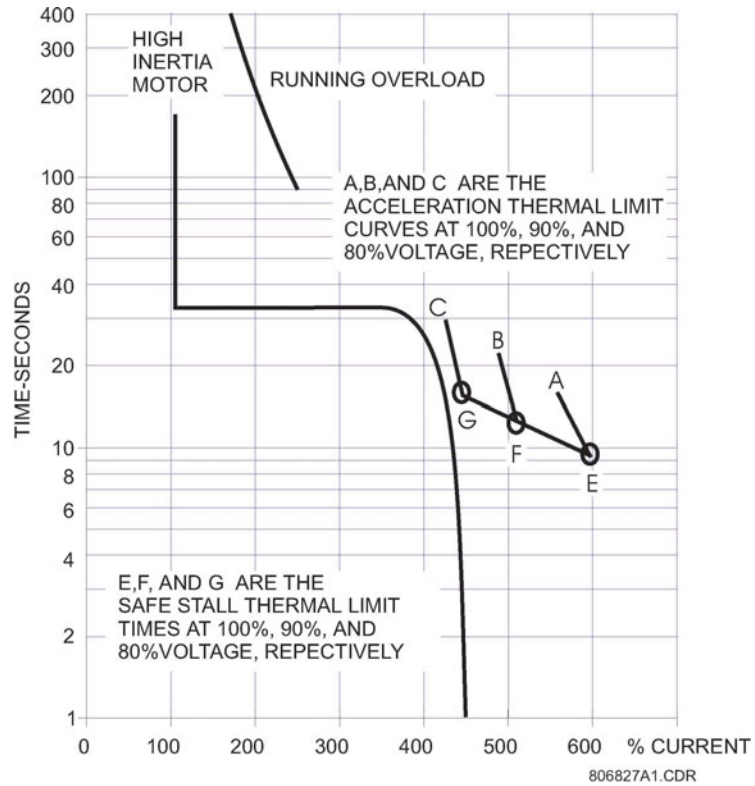



FIGURE 5-6: Typical Time-current and Thermal Limit Curves (ANSI/IEEE C37.96)

### 5.4.2 Thermal Model

PATH: S3 OVERLOAD PROTECTION ↓ THERMAL MODEL

<b>THERMAL MODEL</b>	ENTER	<b>OVERLOAD PICKUP LEVEL: 1.01 x FLA</b>	Range: 1.01 to 1.25 in steps of 0.01
	▼	<b>THERMAL CAPACITY ALARM: Off</b>	Range: Off, Latched, Unlatched
	↕	<b>ASSIGN TC ALARM RELAYS: Alarm</b>	Range: None, Alarm, Aux1, Aux2, or combinations of them
	↕	<b>TC ALARM LEVEL: 75 % Used</b>	Range: 1 to 100% in steps of 1
	↕	<b>THERMAL CAPACITY ALARM EVENTS: No</b>	Range: No, Yes
	↕	<b>ASSIGN TC TRIP RELAYS: Trip</b>	Range: None, Trip, Aux1, Aux2 or combinations of them (TC trip always on and latched)
	↕	<b>ENABLE UNBALANCE BIAS OF TC: Off</b>	Range: On, Off
	↕	<b>UNBALANCE BIAS K FACTOR: Learned</b>	Range: Learned, 1 to 29 in steps of 1 Only shown if UNBALANCE BIAS is enabled
	↕	<b>HOT/COLD SAFE STALL RATIO: 1.00</b>	Range: 0.01 to 1.00 in steps of 0.01

⇅	<b>ENABLE LEARNED COOL TIME: No</b>	Range: No, Yes
⇅	<b>RUNNING COOL TIME CONSTANT: 15 min.</b>	Range: 1 to 500 min. in steps of 1 Not shown if LEARNED COOL TIME is enabled
⇅	<b>STOPPED COOL TIME CONSTANT: 30 min.</b>	Range: 1 to 500 min. in steps of 1 Not shown if Learned Cool time is enabled
⇅	<b>ENABLE RTD BIASING: No</b>	Range: No, Yes
⇅	<b>RTD BIAS MINIMUM: 40 °C</b>	Range: 1 to RTD BIAS MID POINT Only shown if RTD BIASING is enabled
⇅	<b>RTD BIAS MID POINT: 120 °C</b>	Range: RTD BIAS MINIMUM to MAXIMUM Only shown if RTD BIASING is enabled
⇅	<b>RTD BIAS MAXIMUM: 155 °C</b>	Range: RTD BIAS MID POINT to 200 Only shown if RTD BIASING is enabled
	<b>MOTOR LOAD AVERAGING INTERVAL: 3 cycles</b>	Range: 3 to 60 cycles in steps of 3

The primary protective function of the 369 is the thermal model. It consists of five key elements: the overload curve and pickup level, unbalance biasing, motor cooling time constants, and temperature biasing based on Hot/Cold motor information and measured stator RTD temperature.

The 369 integrates both stator and rotor heating into one model. Motor heating is reflected in the **THERMAL CAPACITY USED** actual value. If stopped for a long period of time, the motor will be at ambient temperature and **THERMAL CAPACITY USED** should be zero. If the motor is in overload, a trip will occur once the thermal capacity used reaches 100%. Insulation does not immediately melt when a motor's thermal limit is exceeded. Rather, the rate of insulation degradation reaches a point where the motor life will be significantly reduced if the condition persists. The thermal capacity used alarm may be used as a warning of an impending overload trip.

The 369 thermal model can be modified to allow compensation for motors used to drive cyclic loads, such as a reciprocating compressor. The **MOTOR LOAD AVERAGING INTERVAL** setting allows the user to dampen the effects of these loads as they relate to the overall interpretation of the motor thermal characteristics. The load cycle can be determined using the 369 waveform capture feature or through external equipment. The size of the load cycle is then entered into the **MOTOR LOAD AVERAGING INTERVAL** setpoint. The 369 uses this value to average the motor load, as applied to the thermal model, over the duration of the load cycle. The result is a damping effect applied to the thermal model. The setting is entered in steps of 3 to correspond with the run rate of the 369 thermal model. For load cycles not evenly divisible by 3, enter a value equal to the next multiple of 3 for the **MOTOR LOAD AVERAGING INTERVAL**.



**Motor load averaging may increase trip/alarm times by 16.7 ms for every additional cycle averaged greater than 3.**

### 5.4.3 Overload Curves

#### Settings

PATH: S3 OVERLOAD PROTECTION ⇓⇓ OVERLOAD CURVE

OVERLOAD CURVE	ENTER	SELECT CURVE STYLE: Standard	Range: Standard, Custom
	LINE ▼	STANDARD OVERLOAD CURVE NUMBER: 4	Range: 1 to 15 in steps of 1 Only seen if CURVE STYLE is Standard
	⇕	TIME TO TRIP AT 1.01xFLA: 17415s	Range: 0 to 65534 s in steps of 1 Only seen if CURVE STYLE is Custom
	⇕	TIME TO TRIP AT 1.05xFLA: 3415 s	Range: 0 to 65534 s in steps of 1 Only seen if CURVE STYLE is Custom
	⇕	TIME TO TRIP AT 1.10xFLA: 1667 s	Range: 0 to 65534 s in steps of 1 Only seen if CURVE STYLE is Custom
	⇕	TIME TO TRIP AT 1.20xFLA: 795 s	Range: 0 to 65534 s in steps of 1 Only seen if CURVE STYLE is Custom
	⇕	TIME TO TRIP AT 1.30xFLA: 507 s	Range: 0 to 65534 s in steps of 1 Only seen if CURVE STYLE is Custom
	⇕	TIME TO TRIP AT 1.40xFLA: 365 s	Range: 0 to 65534 s in steps of 1 Only seen if CURVE STYLE is Custom
	⇕	TIME TO TRIP AT 1.50xFLA: 280 s	Range: 0 to 65534 s in steps of 1 Only seen if CURVE STYLE is Custom
	⇕	TIME TO TRIP AT 1.75xFLA: 170 s	Range: 0 to 65534 s in steps of 1 Only seen if CURVE STYLE is Custom
	⇕	TIME TO TRIP AT 2.00xFLA: 117 s	Range: 0 to 65534 s in steps of 1 Only seen if CURVE STYLE is Custom
	⇕	TIME TO TRIP AT 2.25xFLA: 86 s	Range: 0 to 65534 s in steps of 1 Only seen if CURVE STYLE is Custom
	⇕	TIME TO TRIP AT 2.50xFLA: 67 s	Range: 0 to 65534 s in steps of 1 Only seen if CURVE STYLE is Custom
	⇕	TIME TO TRIP AT 2.75xFLA: 53 s	Range: 0 to 65534 s in steps of 1 Only seen if CURVE STYLE is Custom
	⇕	TIME TO TRIP AT 3.00xFLA: 44 s	Range: 0 to 65534 s in steps of 1 Only seen if CURVE STYLE is Custom
⇕	TIME TO TRIP AT 3.25xFLA: 37 s	Range: 0 to 65534 s in steps of 1 Only seen if CURVE STYLE is Custom	
⇕	TIME TO TRIP AT 3.50xFLA: 31 s	Range: 0 to 65534 s in steps of 1 Only seen if CURVE STYLE is Custom	
⇕	TIME TO TRIP AT 3.75xFLA: 27 s	Range: 0 to 65534 s in steps of 1 Only seen if CURVE STYLE is Custom	
⇕	TIME TO TRIP AT 4.00xFLA: 23 s	Range: 0 to 65534 s in steps of 1 Only seen if CURVE STYLE is Custom	
⇕	TIME TO TRIP AT 4.25xFLA: 21 s	Range: 0 to 65534 s in steps of 1 Only seen if CURVE STYLE is Custom	



⇅	TIME TO TRIP AT 4.50xFLA: 18 s	Range: 0 to 65534 s in steps of 1 Only seen if CURVE STYLE is Custom
⇅	TIME TO TRIP AT 4.75xFLA: 16 s	Range: 0 to 65534 s in steps of 1 Only seen if CURVE STYLE is Custom
⇅	TIME TO TRIP AT 5.00xFLA: 15 s	Range: 0 to 65534 s in steps of 1 Only seen if CURVE STYLE is Custom
⇅	TIME TO TRIP AT 5.50xFLA: 12 s	Range: 0 to 65534 s in steps of 1 Only seen if CURVE STYLE is Custom
⇅	TIME TO TRIP AT 6.00xFLA: 10 s	Range: 0 to 65534 s in steps of 1 Only seen if CURVE STYLE is Custom
⇅	TIME TO TRIP AT 6.50xFLA: 9 s	Range: 0 to 65534 s in steps of 1 Only seen if CURVE STYLE is Custom
⇅	TIME TO TRIP AT 7.00xFLA: 7 s	Range: 0 to 65534 s in steps of 1 Only seen if CURVE STYLE is Custom
⇅	TIME TO TRIP AT 7.50xFLA: 6 s	Range: 0 to 65534 s in steps of 1 Only seen if CURVE STYLE is Custom
⇅	TIME TO TRIP AT 8.00xFLA: 6 s	Range: 0 to 65534 s in steps of 1 Only seen if CURVE STYLE is Custom
⇅	TIME TO TRIP AT 10.0xFLA: 6 s	Range: 0 to 65534 s in steps of 1 Only seen if CURVE STYLE is Custom
⇅	TIME TO TRIP AT 15.0xFLA: 6 s	Range: 0 to 65534 s in steps of 1 Only seen if CURVE STYLE is Custom
	TIME TO TRIP AT 20.0xFLA: 6 s	Range: 0 to 65534 s in steps of 1 Only seen if CURVE STYLE is Custom

### Standard Overload Curve:

The overload curve accounts for motor heating during stall, acceleration, and running in both the stator and the rotor. The **OVERLOAD PICKUP** setpoint dictates where the running overload curve begins as the motor enters an overload condition. This is useful for service factor motors as it allows the pickup level to be defined. The curve is effectively cut off at current values below this pickup.

Motor thermal limits consist of three distinct parts based on the three conditions of operation, locked rotor or stall, acceleration, and running overload. Each of these curves may be provided for both a hot motor and a cold motor. A hot motor is defined as one that has been running for a period of time at full load such that the stator and rotor temperatures have settled at their rated temperature. A cold motor is defined as a motor that has been stopped for a period of time such that the stator and rotor temperatures have settled at ambient temperature. For most motors, the distinct characteristics of the motor thermal limits are formed into one smooth homogeneous curve. Sometimes only a safe stall time is provided. This is acceptable if the motor has been designed conservatively and can easily perform its required duty without infringing on the thermal limit. In this case, the protection can be conservative and process integrity is not compromised. If a motor has been designed very close to its thermal limits when operated as required, then the distinct characteristics of the thermal limits become important.

The 369 overload curve can take one of two formats: Standard or Custom Curve. Regardless of which curve style is selected, the 369 will retain thermal memory in the form of a register called **THERMAL CAPACITY USED**. This register is updated every 100 ms using the following equation:

$$TCused_t = TCused_{t-100\text{ ms}} + \frac{100\text{ ms}}{\text{time\_to\_trip}} \times 100\% \tag{EQ 5.2}$$

where: time\_to\_trip = time taken from the overload curve at  $I_{eq}$  as a function of FLA.

The overload protection curve should always be set slightly lower than the thermal limits provided by the manufacturer. This will ensure that the motor is tripped before the thermal limit is reached.

If the motor starting times are well within the safe stall times, it is recommended that the 369 Standard Overload Curves be used. The standard overload curves are a series of 15 curves with a common curve shape based on typical motor thermal limit curves (see FIGURE 5-7: 369 Standard Overload Curves on page 5-146 and FIGURE 5-7: 369 Standard Overload Curves on page 5-146).

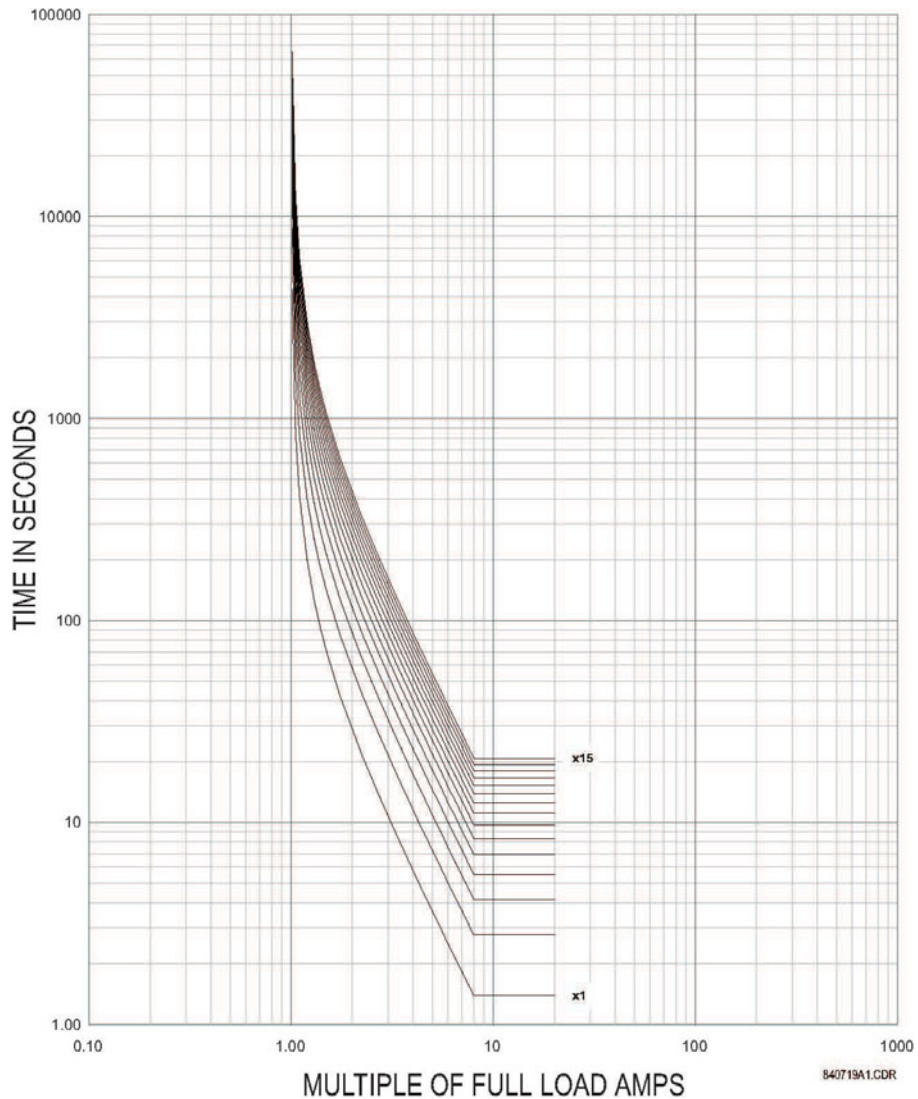

FIGURE 5-7: 369 Standard Overload Curves

Table 5-1: 369 STANDARD OVERLOAD CURVES

PICKUP LEVEL (× FLA)	STANDARD CURVE MULTIPLIERS														
	× 1	× 2	× 3	× 4	× 5	× 6	× 7	× 8	× 9	× 10	× 11	× 12	× 13	× 14	× 15
1.01	4353.6	8707.2	13061	17414	21768	26122	30475	34829	39183	43536	47890	52243	56597	60951	65304
1.05	853.71	1707.4	2561.1	3414.9	4268.6	5122.3	5976.0	6829.7	7683.4	8537.1	9390.8	10245	11098	11952	12806
1.10	416.68	833.36	1250.0	1666.7	2083.4	2500.1	2916.8	3333.5	3750.1	4166.8	4583.5	5000.2	5416.9	5833.6	6250.2
1.20	198.86	397.72	596.58	795.44	994.30	1193.2	1392.0	1590.9	1789.7	1988.6	2187.5	2386.3	2585.2	2784.1	2982.9
1.30	126.80	253.61	380.41	507.22	634.02	760.82	887.63	1014.4	1141.2	1268.0	1394.8	1521.6	1648.5	1775.3	1902.1
1.40	91.14	182.27	273.41	364.55	455.68	546.82	637.96	729.09	820.23	911.37	1002.5	1093.6	1184.8	1275.9	1367.0
1.50	69.99	139.98	209.97	279.96	349.95	419.94	489.93	559.92	629.91	699.90	769.89	839.88	909.87	979.86	1049.9
1.75	42.41	84.83	127.24	169.66	212.07	254.49	296.90	339.32	381.73	392.15	466.56	508.98	551.39	593.81	636.22
2.00	29.16	58.32	87.47	116.63	145.79	174.95	204.11	233.26	262.42	291.58	320.74	349.90	379.05	408.21	437.37
2.25	21.53	43.06	64.59	86.12	107.65	129.18	150.72	172.25	193.78	215.31	236.84	258.37	279.90	301.43	322.96
2.50	16.66	33.32	49.98	66.64	83.30	99.96	116.62	133.28	149.94	166.60	183.26	199.92	216.58	233.24	249.90
2.75	13.33	26.65	39.98	53.31	66.64	79.96	93.29	106.62	119.95	133.27	146.60	159.93	173.25	186.58	199.91
3.00	10.93	21.86	32.80	43.73	54.66	65.59	76.52	87.46	98.39	109.32	120.25	131.19	142.12	153.05	163.98
3.25	9.15	18.29	27.44	36.58	45.73	54.87	64.02	73.16	82.31	91.46	100.60	109.75	118.89	128.04	137.18
3.50	7.77	15.55	23.32	31.09	38.87	46.64	54.41	62.19	69.96	77.73	85.51	93.28	101.05	108.83	116.60
3.75	6.69	13.39	20.08	26.78	33.47	40.17	46.86	53.56	60.25	66.95	73.64	80.34	87.03	93.73	100.42
4.00	5.83	11.66	17.49	23.32	29.15	34.98	40.81	46.64	52.47	58.30	64.13	69.96	75.79	81.62	87.45
4.25	5.12	10.25	15.37	20.50	25.62	30.75	35.87	41.00	46.12	51.25	56.37	61.50	66.62	71.75	76.87
4.50	4.54	9.08	13.63	18.17	22.71	27.25	31.80	36.34	40.88	45.42	49.97	54.51	59.05	63.59	68.14
4.75	4.06	8.11	12.17	16.22	20.28	24.33	28.39	32.44	36.50	40.55	44.61	48.66	52.72	56.77	60.83
5.00	3.64	7.29	10.93	14.57	18.22	21.86	25.50	29.15	32.79	36.43	40.08	43.72	47.36	51.01	54.65
5.50	2.99	5.98	8.97	11.96	14.95	17.94	20.93	23.91	26.90	29.89	32.88	35.87	38.86	41.85	44.84
6.00	2.50	5.00	7.49	9.99	12.49	14.99	17.49	19.99	22.48	24.98	27.48	29.98	32.48	34.97	37.47
6.50	2.12	4.24	6.36	8.48	10.60	12.72	14.84	16.96	19.08	21.20	23.32	25.44	27.55	29.67	31.79
7.00	1.82	3.64	5.46	7.29	9.11	10.93	12.75	14.57	16.39	18.21	20.04	21.86	23.68	25.50	27.32
7.50	1.58	3.16	4.75	6.33	7.91	9.49	11.08	12.66	14.24	15.82	17.41	18.99	20.57	22.15	23.74
8.00	1.39	2.78	4.16	5.55	6.94	8.33	9.71	11.10	12.49	13.88	15.27	16.65	18.04	19.43	20.82
10.00	1.39	2.78	4.16	5.55	6.94	8.33	9.71	11.10	12.49	13.88	15.27	16.65	18.04	19.43	20.82
15.00	1.39	2.78	4.16	5.55	6.94	8.33	9.71	11.10	12.49	13.88	15.27	16.65	18.04	19.43	20.82
20.00	1.39	2.78	4.16	5.55	6.94	8.33	9.71	11.10	12.49	13.88	15.27	16.65	18.04	19.43	20.82



Above 8.0 x Pickup, the trip time for 8.0 is used. This prevents the overload curve from acting as an instantaneous element.

The Standard Overload Curves equation is:

$$\text{time\_to\_trip} = \frac{\text{curve\_multiplier} \times 2.2116623}{0.02530337 \times (\text{pickup} - 1)^2 + 0.05054758 \times (\text{pickup} - 1)} \quad \text{(EQ 5.3)}$$

### Custom Overload Curve:

If the motor starting current begins to infringe on the thermal damage curves, it may be necessary to use a custom curve to ensure successful starting without compromising motor protection. Furthermore, the characteristics of the starting thermal damage curve (locked rotor and acceleration) and the running thermal damage curves may not fit together very smoothly. In this instance, it may be necessary to use a custom curve to tailor protection to the motor thermal limits so the motor may be started successfully and used to its full potential without compromising protection. The distinct parts of the thermal limit curves now become more critical. For these conditions, it is recommended that the 369 custom curve thermal model be used. The custom overload curve of the 369 allows the user to program their own curve by entering trip times for 30 pre-determined current levels. The 369 smooths the areas between these points to make the protection curve.

It can be seen below that if the running overload thermal limit curve were smoothed into one curve with the locked rotor overload curve, the motor could not start at 80% line voltage. A custom curve is required.

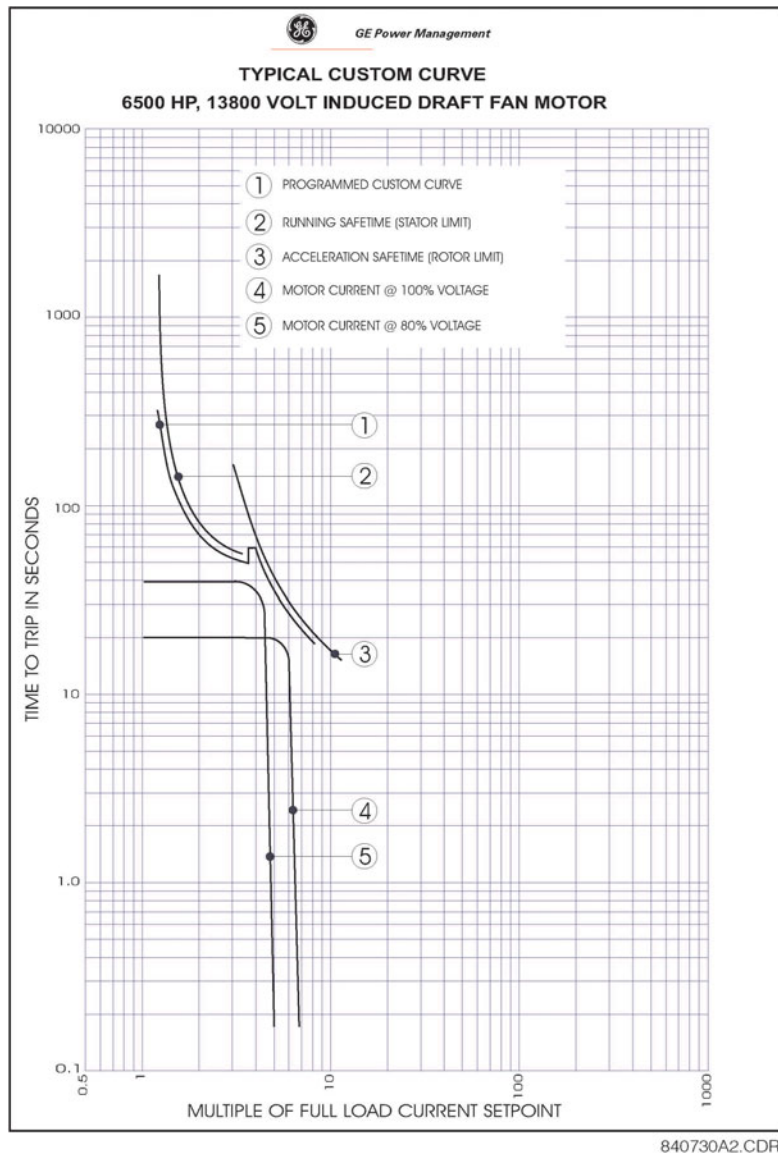

FIGURE 5-8: Custom Curve Example



NOTE

During the interval of discontinuity, the longer of the two trip times is used to reduce the chance of nuisance tripping during motor starts.

### Unbalance Bias

Unbalanced phase currents cause additional rotor heating not accounted for by electromechanical relays and may not be accounted for in some electronic protective relays. When the motor is running, the rotor rotates in the direction of the positive-sequence current at near synchronous speed. Negative-sequence current, having a phase rotation opposite to the positive sequence current, and hence, opposite to the rotor rotation, generates a rotor voltage that produces a substantial rotor current. This induced current has a frequency approximately twice the line frequency: 100 Hz for a 50 Hz system,

120 Hz for a 60 Hz system. Skin effect in the rotor bars at this frequency causes a significant increase in rotor resistance, and therefore a significant increase in rotor heating. This extra heating is not accounted for in the motor manufacturer thermal limit curves, since these curves assume positive-sequence currents only from a perfectly balanced supply and motor design.

The 369 measures the percentage unbalance for the phase currents. The thermal model may be biased to reflect the additional heating caused by negative-sequence current, present during an unbalance when the motor is running. This is done by creating an equivalent motor heating current that takes into account the unbalanced current effect along with the average phase current. This current is calculated as follows:

$$I_{eq} = \frac{I_{avg} \sqrt{1 + k \times (UB\%)^2}}{FLA} \tag{EQ 5.4}$$

- where:  $I_{eq}$  = equivalent unbalance biased heating current
- $I_{avg}$  = average RMS phase current measured
- UB% = unbalance percentage measured (100% = 1, 50% = 0.5, etc.)
- k = unbalance bias k factor

The figure on the left shows motor derating as a function of voltage unbalance as recommended by the American organization NEMA (National Electrical Manufacturers Association). Assuming a typical induction motor with an inrush of  $6 \times FLA$  and a negative sequence impedance of 0.167, voltage unbalances of 1, 2, 3, 4, and 5% equal current unbalances of 6, 12, 18, 24, and 30% respectively. Based on this assumption, the figure on the right below illustrates the amount of motor derating for different values of k entered for the setpoint **UNBALANCE BIAS K FACTOR**. Note that the curve for  $k = 8$  is almost identical to the NEMA derating curve.

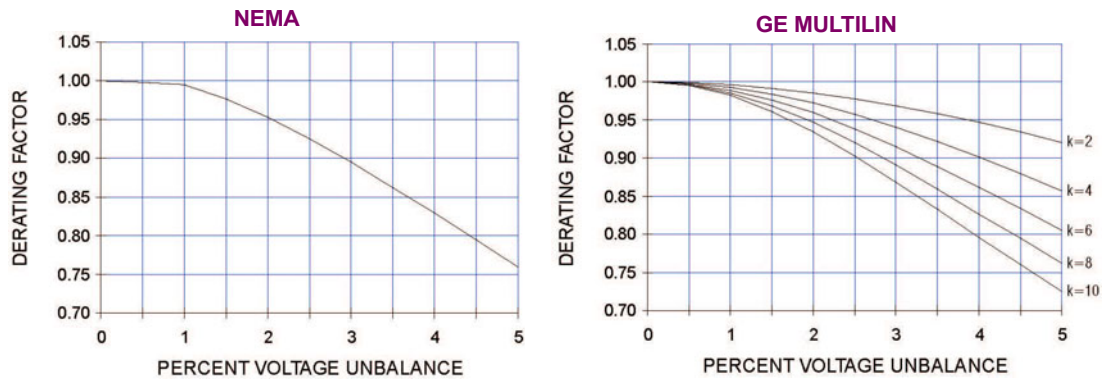

FIGURE 5-9: Medium Motor Derating Factor due to Unbalanced Voltage

If a k value of 0 is entered, the unbalance biasing is defeated and the overload curve will time out against the measured per unit motor current. The k value may be calculated as:

$$k = \frac{175}{I_{LR}^2} \text{ (typical estimate); } k = \frac{230}{I_{LR}^2} \text{ (conservative estimate), where } I_{LR} \text{ is the per unit locked rotor current} \tag{EQ 5.5}$$

The 369 can also learn the unbalance bias k factor. It is recommended that the learned k factor not be enabled until the motor has had at least five successful starts. The calculation of the learned k factor is as follows:

$$k = \frac{175}{(I_{LSC}/FLA)^2} \quad \text{where } I_{LSC} = \text{learned start current, FLA} = \text{Full Load Amps setpoint} \quad \text{(EQ 5.6)}$$

### Motor Cooling

The thermal capacity used quantity is reduced in an exponential manner when the motor is stopped or current is below the overload pickup setpoint. This reduction simulates motor cooling. The motor cooling time constants should be entered for both the stopped and running cases. A stopped motor will normally cool significantly slower than a running motor. Note that the cool time constant is one fifth the total cool time from 100% thermal capacity used down to 0% thermal capacity used.

The 369 can learn and estimate the stopped and running cool time constants for a motor. Calculation of a cool time constant is performed whenever the motor state transitions from starting to running or from running to stopped. The learned cool times are based on the cooling rate of the hottest stator RTD, the hot/cold ratio, the ambient temperature (40 if no ambient RTD), the measured motor load and the programmed service factor or overload pickup. Learned values should only be enabled for motors that have been started, stopped and run at least five times.

Note that any learned cool time constants are mainly based on *stator* RTD information. Cool time, for starting, is typically a rotor limit. The use of stator RTDs can only render an approximation. The learned values should only be used if the real values are not available from the motor manufacturer. Motor cooling is calculated using the following formulas:

$$TC_{used} = (TC_{used\_start} - TC_{used\_end}) \cdot (e^{-t/\tau}) + TC_{used\_end} \quad \text{(EQ 5.7)}$$

$$TC_{used\_end} = I_{eq} \times \left(1 - \frac{\text{hot}}{\text{cold}}\right) \times 100\% \quad \text{(EQ 5.8)}$$

where:  $TC_{used}$  = thermal capacity used  
 $TC_{used\_start}$  = TC used value caused by overload condition  
 $TC_{used\_end}$  = TC used value set by the hot/cold curve ratio when motor is running = '0' when motor is stopped.  
 $t$  = time in minutes  
 $\tau$  = cool time constant (running or stopped)  
 $I_{eq}$  = equivalent motor heating current  
 overload\_pickup = overload pickup setpoint as a multiple of FLA  
 hot/cold = hot/cold curve ratio

### Hot/Cold Curve Ratio

The motor manufacturer will sometimes provide thermal limit information for a hot/cold motor. The 369 thermal model will adapt for these conditions if the Hot/Cold Curve Ratio is programmed. The value entered for this setpoint dictates the level of thermal capacity used that the relay will settle at for levels of current that are below the Overload Pickup Level. When the motor is running at a level that is below the Overload Pickup Level, the thermal capacity used will rise or fall to a value based on the average phase current and the entered Hot/Cold Curve Ratio. Thermal capacity used will either rise at a fixed rate of 5% per minute or fall as dictated by the running cool time constant.

$$TC_{used\_end} = I_{eq} \times \left(1 - \frac{\text{hot}}{\text{cold}}\right) \times 100\% \quad \text{(EQ 5.9)}$$

where:  $TC_{used\_end}$  = Thermal Capacity Used if  $I_{per\_unit}$  remains steady state  
 $I_{eq}$  = equivalent motor heating current  
 hot/cold = **HOT/COLD CURVE RATIO** setpoint

The hot/cold curve ratio may be determined from the thermal limit curves if provided or the hot and cold safe stall times. Simply divide the hot safe stall time by the cold safe stall time. If hot and cold times are not provided, there can be no differentiation and the hot/cold curve ratio should be entered as 1.00.

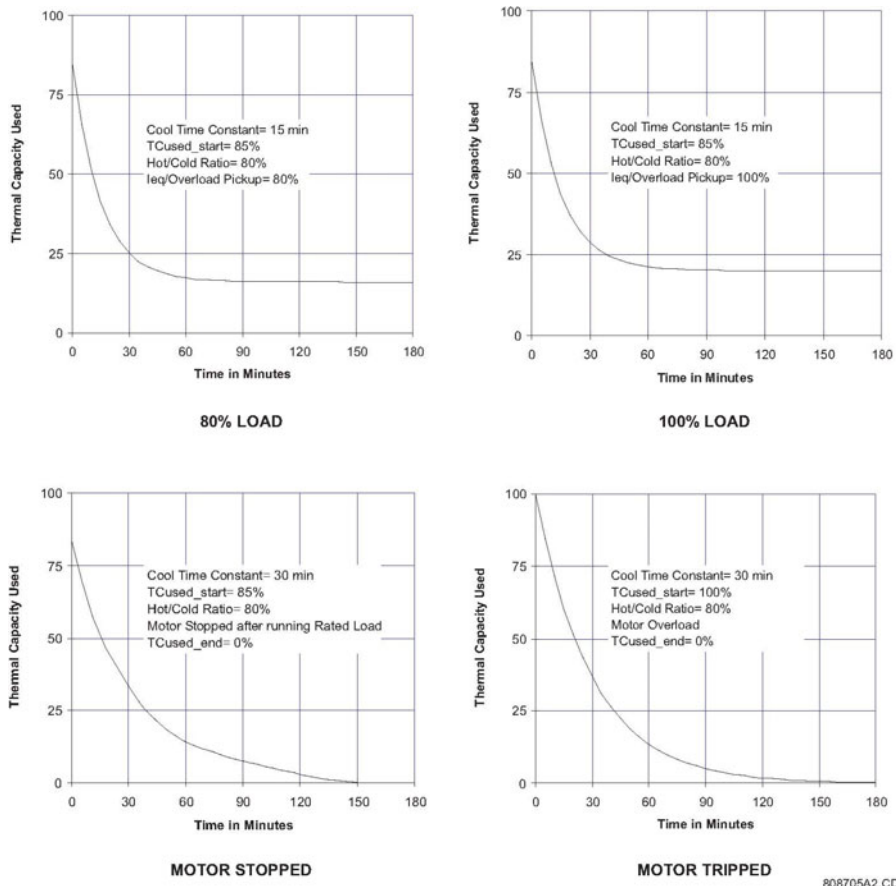

FIGURE 5-10: Thermal Model Cooling

**RTD Bias**

The 369 thermal replica operates as a complete and independent model. The thermal overload curves however, are based solely on measured current, assuming a normal 40°C ambient and normal motor cooling. If there is an unusually high ambient temperature, or if motor cooling is blocked, motor temperature will increase. If the motor stator has embedded RTDs, the 369 RTD bias feature should be used to correct the thermal model.

The RTD bias feature is a two part curve constructed using three points. If the maximum stator RTD temperature is below the RTD Bias Minimum setpoint (typically 40°C), no biasing occurs. If the maximum stator RTD temperature is above the RTD Bias Maximum setpoint (typically at the stator insulation rating or slightly higher), then the thermal memory is fully biased and thermal capacity is forced to 100% used. At values in between, the present thermal capacity used created by the overload curve and other elements of the thermal



model is compared to the RTD Bias thermal capacity used from the RTD Bias curve. If the RTD Bias thermal capacity used value is higher, then that value is used from that point onward. The RTD Bias Center point should be set at the rated running temperature of the motor. The 369 will automatically determine the thermal capacity used value for the center point using the **HOT/COLD SAFE STALL RATIO** setpoint.

$$TC_{used@RTD\_Bias\_Center} = \left(1 - \frac{\text{hot}}{\text{cold}}\right) \times 100\% \quad (\text{EQ 5.10})$$

At temperatures less than the RTD\_Bias\_Center temperature,

$$RTD\_Bias\_TC_{used} = \frac{T_{actual} - T_{min}}{T_{center} - T_{min}} \times TC_{used@RTD\_Bias\_Center} \quad (\text{EQ 5.11})$$

At temperatures greater than the RTD\_Bias\_Center temperature,

$$RTD\_Bias\_TC_{used} = \frac{T_{actual} - T_{center}}{T_{max} - T_{center}} \times (100 - TC_{used@RTD\_Bias\_Center}) + TC_{used@RTD\_Bias\_Center} \quad (\text{EQ 5.12})$$

where: RTD\_Bias\_TCused = TC used due to hottest stator RTD

$T_{actual}$  = Actual present temperature of hottest stator RTD

$T_{min}$  = RTD Bias minimum setpoint (ambient temperature)

$T_{center}$  = RTD Bias center setpoint (motor running temperature)

$T_{max}$  = RTD Bias max setpoint (winding insulation rating temperature)

$TC_{used@RTD\_Bias\_Center}$  = TC used defined by **HOT/COLD SAFE STALL RATIO** setpoint

In simple terms, the RTD bias feature is real feedback of measured stator temperature. This feedback acts as correction of the thermal model for unforeseen situations. Since RTDs are relatively slow to respond, RTD biasing is good for correction and slow motor heating. The rest of the thermal model is required during starting and heavy overload conditions when motor heating is relatively fast.

It should be noted that the RTD bias feature alone cannot create a trip. If the RTD bias feature forces the thermal capacity used to 100%, the motor current must be above the overload pickup before an overload trip occurs. Presumably, the motor would trip on programmed stator RTD temperature setpoint at that time.

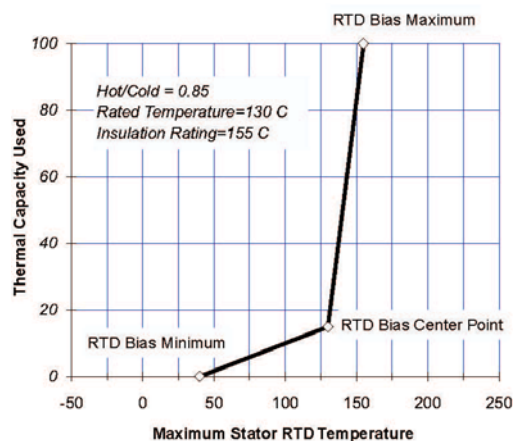

FIGURE 5-11: RTD Bias Curve

### 5.4.4 Overload Alarm

PATH: S3 OVERLOAD PROTECTION ↕↕↕ OVERLOAD ALARM

OVERLOAD ALARM	ENTER	OVERLOAD ALARM: Off	Range: Off, Latched, Unlatched
	LINE ▼	OVERLOAD ALARM LEVEL: 1.01 x FLA	Range: 1.01 to 1.50 in steps of 0.01
	↕	ASSIGN O/L ALARM RELAYS: Alarm	Range: None, Alarm, Aux1, Aux2, or combinations
	↕	OVERLOAD ALARM DELAY: 1 s	Range: 0 to 60.0 s in steps of 0.1
	LINE ▲	OVERLOAD ALARM EVENTS: Off	Range: On, Off

An overload alarm will occur only when the motor is running and the current rises above the programmed **OVERLOAD ALARM LEVEL**. The overload alarm is disabled during a start. An application of an unlatched overload alarm is to signal a PLC that controls the load on the motor, whenever the motor is too heavily loaded.

## 5.5 S4 Current Elements

### 5.5.1 Description

These elements deal with functions that are based on the current readings of the 369 from the external phase and/or ground CTs. All models of the 369 include these features.

### 5.5.2 Short Circuit

PATH: S4 CURRENT ELEMENTS ↓ SHORT CIRCUIT

SHORT CIRCUIT	ENTER	SHORT CIRCUIT TRIP: Off	Range: 50/60 Hz Nominal: Off, Latched, Unlatched Variable: Off, Latched
	LINE	ASSIGN S/C TRIP RELAYS: Trip	Range: None, Trip, Aux1, Aux2, or combinations of them
	↕	SHORT CIRCUIT TRIP LEVEL: 10.0 x CT	Range: 2.0 to 20.0 x CT in steps of 0.1
	↕	ADD S/C TRIP DELAY: 0.00 s	Range: 0 to 255.00 s in steps of 0.01 0 = Instantaneous
	↕	SHORT CIRCUIT TRIP BACKUP: Off	Range: 50/60 Hz Nominal: Off, Latched, Unlatched Variable: Off, Latched
	↕	ASSIGN S/C BACKUP RELAYS: Aux1	Range: None, Aux1, Aux2, or combinations of them
	LINE	ADD S/C BACKUP TRIP DELAY: 0.20 s	Range: 0 to 255.00 s in steps of 0.01 0 = Instantaneous



NOTE

Care must be taken when turning on this feature. If the interrupting device (contactor or circuit breaker) is not rated to break the fault current, this feature should be disabled. Alternatively, this feature may be assigned to an auxiliary relay and connected such that it trips an upstream device that is capable of breaking the fault current.

Once the magnitude of either phase A, B, or C exceeds the Pickup Level × Phase CT Primary for a period of time specified by the delay, a trip will occur. Note the delay is in addition to the 45 ms instantaneous operate time.

There is also a backup trip feature that can be enabled. The backup delay should be greater than the short circuit delay plus the breaker clearing time. If a short circuit trip occurs with the backup on, and the phase current to the motor persists for a period of time that exceeds the backup delay, a second backup trip will occur. It is intended that this second trip be assigned to Aux1 or Aux2 which would be dedicated as an upstream breaker trip relay.

Various situations (e.g. charging a long line to the motor or power factor correction capacitors) may cause transient inrush currents during motor starting that may exceed the Short Circuit Pickup level for a very short period of time. The Short Circuit time delay is adjustable in 10 ms increments. The delay can be fine tuned to an application such that it

still responds very fast, but rides through normal operational disturbances. Normally, the Phase Short Circuit time delay will be set as quick as possible, 0 ms. Time may have to be increased if nuisance tripping occurs.

When a motor starts, the starting current (typically  $6 \times \text{FLA}$  for an induction motor) has an asymmetrical component. This asymmetrical current may cause one phase to see as much as 1.6 times the normal RMS starting current. If the short circuit level was set at 1.25 times the symmetrical starting current, it is probable that there would be nuisance trips during motor starting. As a rule of thumb the short circuit protection is typically set to at least 1.6 times the symmetrical starting current value. This allows the motor to start without nuisance tripping.



Both the main Short Circuit delay and the backup delay start timing when the current exceeds the Short Circuit Pickup level.

### 5.5.3 Mechanical Jam

PATH: S4 CURRENT ELEMENTS ⇓⇓ MECHANICAL JAM

<b>MECHANICAL JAM</b>	ENTER	<b>MECHANICAL JAM ALARM: Off</b>	Range: Off, Latched, Unlatched
	LINE ▼	<b>ASSIGN ALARM RELAYS: Alarm</b>	Range: None, Alarm, Aux1, Aux2, or combinations
	⇕	<b>MECHANICAL JAM ALARM LEVEL: 1.50 x FLA</b>	Range: 1.01 to 6.00 x FLA in steps of 0.01
	⇕	<b>MECHANICAL JAM ALARM DELAY: 1.0 s</b>	Range: 0.5 to 125.0 s in steps of 0.5
	⇕	<b>MECHANICAL JAM ALARM EVENTS: Off</b>	Range: On, Off
	⇕	<b>MECHANICAL JAM TRIP: Off</b>	Range: Off, Latched, Unlatched
	⇕	<b>ASSIGN TRIP RELAYS: Trip</b>	Range: None, Trip, Aux1, Aux2, or combinations of them
	⇕	<b>MECHANICAL JAM TRIP LEVEL: 1.50 x FLA</b>	Range: 1.01 to 6.00 x FLA in steps of 0.01
	LINE ▲	<b>MECHANICAL JAM TRIP DELAY: 1.0 s</b>	Range: 0.5 to 125.0 s in steps of 0.5

After a motor start, once the magnitude of any one of either phase A, B, or C exceeds the Trip/Alarm Pickup Level  $\times$  FLA for a period of time specified by the Delay, a Trip/Alarm will occur. This feature may be used to indicate a stall condition when running. Not only does it protect the motor by taking it off-line quicker than the thermal model (overload curve), it may also prevent or limit damage to the driven equipment that may occur if motor starting torque persists on jammed or broken equipment.

The level for the Mechanical Jam Trip should be set higher than motor loading during normal operations, but lower than the motor stall level. Normally the delay would be set to the minimum time delay, or set such that no nuisance trips occur due to momentary load fluctuations.

## 5.5.4 Undercurrent

### PATH: S4 CURRENT ELEMENTS ⇅⇅⇅ UNDERCURRENT

UNDERCURRENT	ENTER	BLOCK UNDERCURRENT FROM START: 0 s	Range: 0 to 15000 s in steps of 1
	LINE ▼	UNDERCURRENT ALARM: Off	Range: Off, Latched, Unlatched
	⇅	ASSIGN U/C ALARM RELAYS: Alarm	Range: None, Alarm, Aux1, Aux2, or combinations of them
	⇅	UNDERCURRENT ALARM LEVEL: 0.70 x FLA	Range: 0.10 to 0.99 x FLA in steps of 0.01
	⇅	UNDERCURRENT ALARM DELAY: 1 s	Range: 1 to 255 s in steps of 1
	⇅	UNDERCURRENT ALARM EVENTS: Off	Range: On, Off
	⇅	UNDERCURRENT TRIP: Off	Range: Off, Latched, Unlatched
	⇅	ASSIGN U/C TRIP RELAYS: Trip	Range: None, Trip, Aux1, Aux2, or combinations of them
	⇅	UNDERCURRENT TRIP LEVEL: 0.70 x FLA	Range: 0.10 to 0.99 x FLA in steps of 0.01
	LINE ▲	UNDERCURRENT TRIP DELAY: 1 s	Range: 1 to 255 s in steps of 1

If enabled, once the magnitude of either phase A, B or C falls below the pickup level  $\times$  FLA for a period of time specified by the Delay, a trip or alarm will occur. The undercurrent element is an indication of loss of load to the motor. Thus, the pickup level should be set lower than motor loading levels during normal operations. The undercurrent element is active when the motor is starting or running.

The undercurrent element can be blocked upon the initiation of a motor start for a period of time specified by the U/C Block From Start setpoint (e.g. this block may be used to allow pumps to build up head before the undercurrent element trips). A value of 0 means undercurrent protection is immediately enabled upon motor starting (no block). If a value other than 0 is entered, the feature will be disabled from the time a start is detected until the time entered expires.

#### Application Example:

If a pump is cooled by the liquid it pumps, loss of load may cause the pump to overheat. Undercurrent protection should thus be enabled. If the motor loading should never fall below  $0.75 \times$  FLA, even for short durations, the Undercurrent Trip pickup could be set to 0.70 and the Undercurrent Alarm to 0.75. If the pump is always started loaded, the block from start feature should be disabled (programmed as 0).

Time delay is typically set as quick as possible, 1 second.

### 5.5.5 Current Unbalance

PATH: S4 CURRENT ELEMENTS ↓↓↓↓ CURRENT UNBALANCE

<b>CURRENT UNBALANCE</b>	ENTER	<b>BLOCK UNBALANCE FROM START: 0 s</b>	Range: 0 to 5000 s in steps of 1
	LINE ▼	<b>CURRENT UNBALANCE ALARM: Off</b>	Range: Off, Latched, Unlatched
	⇅	<b>ASSIGN U/B ALARM RELAYS: Alarm</b>	Range: None, Alarm, Aux1, Aux2, or combinations of them
	⇅	<b>UNBALANCE ALARM LEVEL: 15 %</b>	Range: 4 to 30% in steps of 1
	⇅	<b>UNBALANCE ALARM DELAY: 1 s</b>	Range: 1 to 255 s in steps of 1
	⇅	<b>UNBALANCE ALARM EVENTS: Off</b>	Range: On, Off
	⇅	<b>CURRENT UNBALANCE TRIP: Off</b>	Range: Off, Latched, Unlatched
	⇅	<b>ASSIGN U/B TRIP RELAYS: Trip</b>	Range: None, Trip, Aux1, Aux2, or combinations of them
	⇅	<b>UNBALANCE TRIP LEVEL: 20 %</b>	Range: 4 to 30% in steps of 1
	LINE ▲	<b>UNBALANCE TRIP DELAY: 1 s</b>	Range: 1 to 255 s in steps of 1

Unbalanced three phase supply voltages are a major cause of induction motor thermal damage. Causes of unbalance can include: increased resistance in one phase due to a pitted or faulty contactor, loose connections, unequal tap settings in a transformer, non-uniformly distributed three phase loads, or varying single phase loads within a plant. The most serious case of unbalance is single phasing – that is, the complete loss of one phase. This can be caused by a utility supply problem or a blown fuse in one phase and can seriously damage a three phase motor. A single phase trip will occur in 2 seconds if the Unbalance trip is on and the level exceeds 30%. A single phase trip will also activate in 2 seconds if the Motor Load is above 30% and at least one of the phase currents is zero. Single phasing protection is disabled if the Unbalance Trip is turned Off.

During balanced conditions in the stator, current in each motor phase is equal, and the rotor current is just sufficient to provide the turning torque. When the stator currents are unbalanced, a much higher current is induced into the rotor due to its lower impedance to the negative sequence current component present. This current is at twice the power supply frequency and produces a torque in the opposite direction to the desired motor output. Usually the increase in stator current is small and timed overcurrent protection takes a long time to trip. However, the much higher induced rotor current can cause extensive rotor damage in a short period of time. Motors can tolerate different levels of current unbalance depending on the rotor design and heat dissipation characteristics.

To prevent nuisance trips/alarms on lightly loaded motors when a much larger unbalance level will not damage the rotor, the unbalance protection will automatically be defeated if the average motor current is less than 30% of the full load current (IFLA) setting. Unbalance is calculated as follows:

$$\begin{aligned} \text{If } I_{avg} \geq I_{FLA}, \text{ Unbalance} &= \frac{|I_{max} - I_{avg}|}{I_{avg}} \times 100 \\ \text{If } I_{avg} < I_{FLA}, \text{ Unbalance} &= \frac{|I_{max} - I_{avg}|}{I_{FLA}} \times 100 \end{aligned} \quad \text{(EQ 5.13)}$$

where:  $I_{avg}$  = average phase current,  
 $I_{max}$  = current in a phase with maximum deviation from  $I_{avg}$ ,  
 $I_{FLA}$  = motor full load amps setting

Unbalance protection is recommended at all times. When setting the unbalance pickup level, it should be noted that a 1% voltage unbalance typically translates into a 6% current unbalance. Therefore, in order to prevent nuisance trips or alarms, the pickup level should not be set too low. Also, since short term unbalances are common, a reasonable delay should be set to avoid nuisance trips or alarms. It is recommended that the unbalance thermal bias feature be used to bias the Thermal Model to account for rotor heating that may be caused by cyclic short term unbalances.

### 5.5.6 Ground Fault

PATH: S4 CURRENT ELEMENTS  $\Downarrow\Downarrow\Downarrow\Downarrow$  GROUND FAULT

GROUND FAULT	ENTER	GROUND FAULT ALARM: Off	Range: 50/60 Hz Nominal: Off, Latched, Unlatched Variable: Off, Latched
	LINE ▼	ASSIGN G/F ALARM RELAYS: Alarm	Range: None, Alarm, Aux1, Aux2, or combinations of them
	↕	GROUND FAULT ALARM LEVEL: 0.10 x CT	Range: 0.10 to 1.00 x CT in steps of 0.01 Only shown if G/F CT is 1A or 5A
	↕	GROUND FAULT ALARM LEVEL: 0.25 A	Range: 0.25 to 25.00 A in steps of 0.01 Only shown if G/F CT is 50:0.025
	↕	GROUND FAULT ALARM DELAY: 0.00 s	Range: 0.00 to 255.00 s in steps of 0.01s
	↕	GROUND FAULT ALARM EVENTS: Off	Range: On, Off
	↕	GROUND FAULT TRIP: Off	Range: 50/60 Hz Nominal: Off, Latched, Unlatched Variable: Off, Latched
	↕	ASSIGN GF TRIP RELAYS: Trip	Range: None, Trip, Aux1, Aux2, or combinations of them
	↕	GROUND FAULT TRIP LEVEL: 0.20 x CT	Range: 0.10 to 1.00 x CT in steps of 0.01 Only shown if Ground Fault CT is 1A or 5A
	↕	GROUND FAULT TRIP LEVEL: 0.25 A	Range: 0.25 to 25.00 A in steps of 0.01 Only shown if Ground Fault CT is 50:0.025
	↕	GROUND FAULT TRIP DELAY: 0.00 s	Range: 0 to 255.00 s in steps of 0.01
	↕	GROUND FAULT TRIP BACKUP: Off	Range: 50/60 Hz Nominal: Off, Latched, Unlatched Variable: Off, Latched
	↕	ASSIGN G/F BACKUP RELAYS: Aux2	Range: None, Aux1, Aux2, or combinations of them



<b>G/F TRIP BACKUP</b> <b>DELAY: 0.20 s</b>
--

Range: 0.00 to 255.00 s in steps of 0.01

Once the magnitude of ground current exceeds the Pickup Level for a period of time specified by the Delay, a trip and/or alarm will occur. There is also a backup trip feature that can be enabled. If the backup is On, and a Ground Fault trip has initiated, and the ground current persists for a period of time that exceeds the backup delay, a second 'backup' trip will occur. It is intended that this second trip be assigned to Aux1 or Aux2 which would be dedicated as an upstream breaker trip relay. The Ground Fault Trip Backup delay must be set to a time longer than the breaker clearing time.



**Care must be taken when turning On this feature. If the interrupting device (contactor or circuit breaker) is not rated to break ground fault current (low resistance or solidly grounded systems), the feature should be disabled. Alternately, the feature may be assigned to an auxiliary relay and connected such that it trips an upstream device that is capable of breaking the fault current.**

Various situations (e.g. contactor bounce) may cause transient ground currents during motor starting that may exceed the Ground Fault Pickup levels for a very short period of time. The delay can be fine tuned to an application such that it still responds very fast, but rides through normal operational disturbances. Normally, the Ground Fault time delays will be set as quick as possible, 0 ms. Time may have to be increased if nuisance tripping occurs.

Special care must be taken when the ground input is wired to the phase CTs in a residual connection. When a motor starts, the starting current (typically  $6 \times \text{FLA}$  for an induction motor) has an asymmetrical component. This asymmetrical current may cause one phase to see as much as 1.6 times the normal RMS starting current. This momentary DC component will cause each of the phase CTs to react differently and the net current into the ground input of the 369 will not be negligible. A 20 ms block of the ground fault elements when the motor starts enables the 369 to ride through this momentary ground current signal.



Both the main Ground Fault delay and the backup delay start timing when the Ground Fault current exceeds the pickup level.



## 5.6 S5 Motor Start/Inhibits

### 5.6.1 Description

These setpoints deal with those functions that prevent the motor from restarting once stopped until a set condition clears and/or a set time expires. None of these functions will trip a motor that is already running.

### 5.6.2 Acceleration Trip

PATH: S5 MOTOR START/INHIBITS ▾ ACCELERATION TRIP

ACCELERATION TRIP	ENTER	ACCELERATION TRIP: Off	<i>Range: Off, Latched, Unlatched</i>
	LINE ▼	ASSIGN TRIP RELAYS: Trip	<i>Range: None, Trip, Aux1, Aux2, or combinations of them</i>
	LINE ▲	ACCELERATION TIME FROM START: 10.0 s	<i>Range: 1.0 to 250.0 s in steps of 0.1</i>

The 369 Thermal Model is designed to protect the motor under both starting and overload conditions. The Acceleration Timer trip feature may be used in addition to that protection. If for example, the motor should always start in 2 seconds, but the safe stall time is 8 seconds, there is no point letting the motor remain in a stall condition for 7 or 8 seconds when the thermal model would take it off line. Furthermore, the starting torque applied to the driven equipment for that period of time could cause severe damage.

If enabled, the Acceleration Timer trip element will function as follows: A motor start is assumed to be occurring when the 369 measures the transition of no motor current to some value of motor current. Typically current will rise quickly to a value in excess of FLA (e.g. 6 x FLA). At this point, the Acceleration Timer will be initialized with the entered value in seconds. If the current does not fall below the overload curve pickup level before the timer expires, an acceleration trip will occur. If the acceleration time of the motor is variable, this feature should be set just beyond the longest acceleration time.



NOTE

**Some motor soft starters may allow current to ramp up slowly while others may limit current to less than Full Load Amps throughout the start. In these cases, as a generic relay that must protect all motors, the 369 cannot differentiate between a motor that has a slow ramp up time and one that has completed a start and gone into an overload condition. Therefore, if the motor current does not rise to greater than full load within 1 second on start, the acceleration timer feature is ignored. In any case, the motor is still protected by the overload curve.**

### 5.6.3 Start Inhibits

#### PATH: S5 MOTOR START/INHIBITS ⇅⇅ START INHIBITS

START INHIBITS	ENTER	ENABLE SINGLE SHOT RESTART: No	Range: No, Yes
	LINE ▼	ENABLE START INHIBIT: No	Range: No, Yes
	⇅	MAX STARTS/HOUR PERMISSIBLE: Off	Range: 1 to 5 in steps of 1, Off (0)
	⇅	TIME BETWEEN STARTS PERMISSIBLE: Off	Range: 1 to 500 min. in steps of 1, Off (0)
	⇅	RESTART BLOCK: Off	Range: 1 to 50000 s in steps of 1, Off (0)
	LINE ▲	ASSIGN BLOCK RELAY: Trip & Aux2	Range: None, Trip, Aux1, Aux2, or combinations

The start inhibit setpoints are individually described below.

- ENABLE SINGLE SHOT RESTART:** Enabling this feature will allow the motor to be restarted immediately after an overload trip has occurred. To accomplish this, a reset will cause the 369 to decrease the accumulated thermal capacity to zero. However, if a second overload trip occurs within one hour of the first, another immediate restart will not be permitted. The displayed lockout time must then be allowed to expire before the motor can be started.
- ENABLE START INHIBIT:** The Start Inhibit feature is intended to help prevent tripping of the motor during a start if there is insufficient thermal capacity for a start. The average value of thermal capacity used from the last five successful starts is multiplied by 1.25 and stored as thermal capacity used on start. This 25% margin is used to ensure that a motor start will be successful. If the number is greater than 100%, 100% is stored as thermal capacity used on start. A successful motor start is one in which phase current rises from 0 to greater than overload pickup and then, after acceleration, falls below the overload curve pickup level. If the Start Inhibit feature is enabled, each time the motor is stopped, the amount of thermal capacity available (100% – Thermal Capacity Used) is compared to the **THERMAL CAPACITY USED ON START**. If the thermal capacity available does not exceed the **THERMAL CAPACITY USED ON START**, or is not equal to 100%, the Start Inhibit will become active until there is sufficient thermal capacity. When an inhibit occurs, the lockout time will be equal to the time required for the motor to cool to an acceptable temperature for a start. This time will be a function of the **COOL TIME CONSTANT STOPPED** programmed. If this feature is turned Off, thermal capacity used must reduce to 15% before an overload lockout resets. This feature should be turned off if the load varies for different starts.
- MAX STARTS/HOUR PERMISSIBLE:** A motor start is assumed to be occurring when the 369 measures the transition of no motor current to some value of motor current. At this point, one of the Starts/Hour timers is loaded with 60 minutes. Even unsuccessful start attempts will be logged as starts for this feature. Once the motor is stopped, the number of starts within the past hour is compared to the number of starts allowable. If the two are the same, an inhibit will occur. If an inhibit occurs, the lockout time will be

equal to one hour less the longest time elapsed since a start within the past hour. An Emergency restart will clear the oldest start time remaining.

- **TIME BETWEEN STARTS PERMISSIBLE:** A motor start is assumed to be occurring when the 369 measures the transition of no motor current to some value of motor current. At this point, the Time Between Starts timer is loaded with the entered time. Even unsuccessful start attempts will be logged as starts for this feature. Once the motor is stopped, if the time elapsed since the most recent start is less than the **TIME BETWEEN STARTS PERMISSIBLE** setpoint, an inhibit will occur. If an inhibit occurs, the lockout time will be equal to the time elapsed since the most recent start subtracted from the **TIME BETWEEN STARTS PERMISSIBLE** setpoint.
- **RESTART BLOCK:** Restart Block may be used to ensure that a certain amount of time passes between stopping a motor and restarting that motor. This timer feature may be very useful for some process applications or motor considerations. If a motor is on a down-hole pump, after the motor stops, the liquid may fall back down the pipe and spin the rotor backwards. It would be very undesirable to start the motor at this time. In another scenario, a motor may be driving a very high inertia load. Once the supply to the motor is disconnected, the rotor may continue to turn for a long period of time as it decelerates. The motor has now become a generator and applying supply voltage out of phase may result in catastrophic failure.
- **ASSIGN BLOCK RELAY:** The relay(s) assigned here will be used for all blocking/inhibit elements in this section. The assigned relay will activate only when the motor is stopped. When a block/inhibit condition times out or is cleared, the assigned relay will automatically reset itself.

#### Notes For All Inhibits And Blocks:

1. In the event of control power loss, all lockout times will be saved. Elapsed time will be recorded and decremented from the inhibit times whether control power is applied or not. Upon control power being re-established to the 369, all remaining inhibits (have not time out) will be re-activated.
2. If the motor is started while an inhibit is active an event titled 'Start while Blocked' will be recorded.

### 5.6.4 Backspin Detection

#### PATH: S5 MOTOR START/INHIBITS ↓↓↓ BACKSPIN DETECTION

<b>BACKSPIN DETECTION</b>	ENTER	<b>ENABLE BACKSPIN START INHIBIT: No</b>	Range: No, Yes Only shown if B option installed
	LINE ▼	<b>MINIMUM PERMISSIBLE FREQUENCY: 0.00 Hz</b>	Range: 0 to 9.99 Hz in steps of 0.01 Shown only if backspin start inhibit is enabled
	↕	<b>PREDICTION ALGORITHM Enabled</b>	Range: Disabled, Enabled Shown only if backspin start inhibit is enabled
	↕	<b>ASSIGN BSD RELAY: Aux2</b>	Range: None, Trip, Aux1, Aux2, or combinations Seen only if backspin start inhibit is enabled
	LINE ▲	<b>NUM OF MOTOR POLES: 2</b>	Range: 2 to 16 in steps of 2 Shown only if backspin start inhibit is enabled

Immediately after the motor is stopped, backspin detection commences and a backspin start inhibit is activated to prevent the motor from being restarted. The backspin frequency is sensed through the BSD voltage input. If the measured frequency is below the programmed **MINIMUM PERMISSIBLE FREQUENCY**, the backspin start inhibit will be removed. The time for the motor to reach the **MINIMUM PERMISSIBLE FREQUENCY** is calculated throughout the backspin state. If the BSD frequency signal is lost prior to reaching the Minimum Permissible Frequency, the inhibit remains active until the prediction time has expired. The calculated Prediction Time and the Backspin State can be viewed in Section 6.3.4 *Backspin Metering* on page 6–208.

### Application:

Backspin protection is typically used on down hole pump motors which can be located several kilometers underground. Check valves are often used to prevent flow reversal when the pump stops. Very often however, the flow reverses due to faulty or non-existent check valves, causing the pump impeller to rotate the motor in the reverse direction. Starting the motor during this period of reverse rotation (back-spinning) may result in motor damage. Backspin detection ensures that the motor can only be started when the motor has slowed to within acceptable limits. Without backspin detection a long time delay had to be used as a start permissive to ensure the motor had slowed to a safe speed.



**These setpoints are only visible when option B has been installed.**

## 5.7 S6 RTD Temperature

### 5.7.1 Description

These setpoints deal with the RTD overtemperature elements of the 369. The Local RTD Protection setpoints will only be seen if the 369 has option R installed. The Remote RTD Protection setpoints will only be seen if the 369 has the RRTD accessory enabled. Both can be enabled and used at the same time and have the same functionality.

### 5.7.2 Local RTD Protection

PATH: S6 RTD TEMPERATURE ↓ LOCAL RTD PROTECTION ↓ LOCAL RTD 1(12)

LOCAL RTD 1	ENTER	RTD 1 APPLICATION: None	Range: None, Stator, Bearing, Ambient, Other
	LINE	RTD 1 TYPE: 100 Ohm Platinum	Range: 10 Ohm Copper, 100 Ohm Nickel, 120 Ohm Nickel, 100 Ohm Platinum.
	↕	RTD 1 NAME: RTD 1	Range: 8 alphanumeric characters
	↕	RTD 1 ALARM: Off	Range: Off, Latched, Unlatched
	↕	RTD 1 ALARM RELAYS: Alarm	Range: None, Alarm, Aux1, Aux2, or combinations
	↕	RTD 1 ALARM LEVEL: 130 °C	Range: 1 to 200°C or 34 to 392°F in steps of 1
	↕	RTD 1 HI ALARM: Off	Range: Off, Latched, Unlatched
	↕	RTD 1 HI ALARM RELAYS: Aux1	Range: None, Alarm, Aux1, Aux2, or combinations
	↕	RTD 1 HI ALARM LEVEL: 130 °C	Range: 1 to 200°C or 34 to 392°F in steps of 1
	↕	RECORD RTD 1 ALARMS AS EVENTS: No	Range: No, Yes
	↕	RTD 1 TRIP: Off	Range: Off, Latched, Unlatched
	↕	RTD 1 TRIP RELAYS: Trip	Range: None, Trip, Aux1, Aux2, or combinations
	↕	RTD 1 TRIP LEVEL: 130 °C	Range: 1 to 200°C or 34 to 392°F in steps of 1
	LINE	ENABLE RTD 1 TRIP VOTING: Off	Range: Off, RTD 1 to RTD12, All Stator



The above setpoints will only be shown if the **RTD 1(12) APPLICATION** setpoint is other than "None"



RTD NAME can not be edited using front panel. EnerVista 369 Setup software should be used to set the RTD NAME.

### 5.7.3 Remote RTD Protection

#### Main Menu

PATH: S6 RTD TEMPERATURE ⇓ REMOTE RTD PROTECTN ⇓ REMOTE RTD MODULE 1(4)

REMOTE RTD MODULE 1	ENTER	RRTD 1 RTD1	See page 5-166
	⇕	RRTD 1 RTD2	See page 5-166
		⇕	
	⇕	RRTD 1 RTD12	See page 5-166
	⇕	RRTD 1 OPEN RTD ALARM: Off	Range: Off, On
	⇕	ASSIGN ALARM RELAYS: Alarm	Range: None, Alarm, Aux1, Aux2, or combinations
	⇕	RRTD 1 OPEN RTD EVENTS: No	Range: No, Yes
	⇕	RRTD 1 SHORT/LOW RTD ALARM: Off	Range: Off, On
	⇕	ASSIGN ALARM RELAYS: Alarm	Range: None, Alarm, Aux1, Aux2, or combinations
	⇕	RRTD 1 SHORT/LOW RTD EVENTS: No	Range: No, Yes

These setpoints are applicable for units with a GE Multilin Remote RTD module.

## Remote RTD 1(12)

PATH: S6 RTD TEMPERATURE ⇅⇅ REMOTE RTD PROTECTN ⇅ REMOTE RTD MODULE 1(4) ⇅⇅ RRTD 1 RTD 1(12)

RRTD 1 RTD # 1	ENTER	<b>RTD 1 APPLICATION:</b> None	<i>Range: None, Stator, Bearing, Ambient, Other</i>
	LINE	<b>RRTD 1 RTD1 TYPE:</b> 100 Ohm Platinum	<i>Range: 10 Ohm Copper, 100 Ohm Nickel, 120 Ohm Nickel, 100 Ohm Platinum</i>
	⇅	<b>RRTD 1 RTD1 NAME:</b> RRTD1	<i>Range: 8 character alphanumeric. Seen only if RRTD 1 APPLICATION is other than "None"</i>
	⇅	<b>RRTD 1 RTD1 ALARM:</b> Off	<i>Range: Off, Latched, Unlatched. Seen only if RRTD 1 APPLICATION is other than "None"</i>
	⇅	<b>RRTD 1 RTD1 ALARM RELAYS:</b> Alarm	<i>Range: None, Alarm, Aux1, Aux2, or combinations. Seen only if RRTD 1 APPLICATION is not "None"</i>
	⇅	<b>RRTD 1 RTD1 ALARM LEVEL:</b> 130 °C	<i>Range: 1 to 200°C or 34 to 392°F in steps of 1. Seen only if RRTD 1 APPLICATION is other than</i>
	⇅	<b>RRTD 1 RTD1 HI ALARM:</b>	<i>Range: Off, Latched, Unlatched. Seen only if RRTD 1 APPLICATION is other than "None".</i>
	⇅	<b>RRTD1 RTD1 HI ALARM RELAY:</b> Aux1	<i>Range: None, Alarm, Aux1, Aux2, or combinations. Seen only if RRTD 1 APPLICATION is not "None".</i>
	⇅	<b>RRTD 1 RTD1 HI ALARM LEVEL:</b> 130 °C	<i>Range: 1 to 200°C or 34 to 392°F in steps of 1. Seen only if RRTD 1 APPLICATION is other than</i>
	⇅	<b>RRTD 1 RTD1 ALARMS AS EVENTS:</b> No	<i>Range: No, Yes. Seen only if RRTD 1 APPLICATION is other than "None".</i>
	⇅	<b>RRTD 1 RTD1 TRIP:</b> Off	<i>Range: Off, Latched, Unlatched. Seen only if RRTD 1 APPLICATION is other than "None".</i>
	⇅	<b>RRTD 1 RTD1 TRIP RELAYS:</b> Trip	<i>Range: None, Trip, Aux1, Aux2, or combinations. Seen only if RRTD 1 APPLICATION is not "None".</i>
	⇅	<b>RRTD 1 RTD1 TRIP LEVEL:</b> 130 °C	<i>Range: 1 to 200°C or 34 to 392°F in steps of 1. Seen only if RRTD 1 APPLICATION is other than</i>
	LINE	<b>RRTD 1 RTD1 TRIP VOTING:</b> Off	<i>Range: Off, RRTD 1 to 12, All Stator. Seen only if RRTD 1 APPLICATION is other than "None"</i>

- **RTD 1(12) APPLICATION:** Each individual RTD may be assigned an application. A setting of "None" turns an individual RTD off. Only RTDs with the application set to "Stator" are used for RTD biasing of the thermal model. If an RTD application is set to "Ambient", then it is used in calculating the learned cool time of the motor.
- **RTD 1(12) TYPE:** Each RTD is individually assigned the RTD type it is connected to. Multiple types may be used with a single 369.
- **RTD 1(12) NAME:** Each RTD may have 8 character name assigned to it. This name is used in alarm and trip messages. RTD NAME can not be edited using front panel. EnerVista 369 Setup software should be used to set the RTD NAME.
- **RTD 1(12) ALARM, RTD 1(12) HI ALARM, and RTD 1(12) TRIP:** Each RTD can be programmed for separate Alarm, Hi Alarm and Trip levels and relays. Trips are

automatically stored as events. Alarms and Hi Alarms are stored as events only if the Record Alarms as Events setpoint for that RTD is set to Yes.

- **RTD 1(12) TRIP VOTING:** This feature provides added RTD trip reliability in situations where malfunction and nuisance tripping is common. If enabled, the RTD trips only if the RTD (or RTDs) to be voted with are also above their trip level. For example, if RTD 1 is set to vote with All Stator RTDs, the 369 will only trip if RTD 1 is above its trip level and any one of the other stator RTDs is also above its own trip level. RTD voting is typically only used on Stator RTDs and typically done between adjacent RTDs to detect hot spots.

Stator RTDs can detect heating due to non overload (current) conditions such as blocked or inadequate cooling and ventilation or high ambient temperature as well as heating due to overload conditions. Bearing or other RTDs can detect overheating of bearings or auxiliary equipment.

Table 5-2: Rtd Resistance to Temperature

TEMPERATURE		RTD RESISTANCE (IN OHMS)			
°C	°F	100 Ohm Pt DIN 43760	120 Ohm Ni	100 Ohm Ni	10 Ohm Cu
-40	-40	84.27	92.76	79.13	7.49
-30	-22	88.22	99.41	84.15	7.88
-20	-4	92.16	106.15	89.23	8.26
-10	14	96.09	113.00	94.58	8.65
0	32	100.00	120.00	100.0	9.04
10	50	103.90	127.17	105.6	9.42
20	68	107.79	134.52	111.2	9.81
30	86	111.67	142.06	117.1	10.19
40	104	115.54	149.79	123.0	10.58
50	122	119.39	157.74	129.1	10.97
60	140	123.24	165.90	135.3	11.35
70	158	127.07	174.25	141.7	11.74
80	176	130.89	182.84	148.3	12.12
90	194	134.70	191.64	154.9	12.51
100	212	138.50	200.64	161.8	12.90
110	230	142.29	209.85	168.8	13.28
120	248	146.06	219.29	176.0	13.67
130	266	149.82	228.96	183.3	14.06
140	284	153.58	238.85	190.9	14.44
150	302	157.32	248.95	198.7	14.83
160	320	161.04	259.30	206.6	15.22
170	338	164.76	269.91	214.8	15.61
180	356	168.47	280.77	223.2	16.00
190	374	172.46	291.96	231.6	16.39
200	392	175.84	303.46	240.0	16.78



### 5.7.4 Open RTD Alarm

PATH: S6 RTD TEMPERATURE ↓↓↓ OPEN LOCAL RTD ALARM

OPEN LOCAL RTD ALARM	ENTER	OPEN LOCAL RTD ALARM: Off	Range: Off, Latched, Unlatched
	LINE ▼	ASSIGN ALARM RELAYS: Alarm	Range: None, Alarm, Aux1, Aux2, or combinations
	LINE ▲	OPEN RTD ALARM EVENTS: No	Range: No, Yes

The 369 has an Open RTD Sensor Alarm. This alarm will look at all RTDs that have been assigned an application other than “None” and determine if an RTD connection has been broken. When a broken sensor is detected, the assigned output relay will operate and a message will appear on the display identifying the RTD that is broken. It is recommended that if this feature is used, the alarm be programmed as latched so that intermittent RTDs are detected and corrective action may be taken.

### 5.7.5 Short/Low Temp RTD Alarm

PATH: S6 RTD TEMPERATURE ↓↓↓↓ SHORT/LOW RTD ALARM

SHORT/LOW RTD ALARM	ENTER	SHORT/LOW TEMP RTD ALARM: Off	Range: Off, Latched, Unlatched
	LINE ▼	ASSIGN ALARM RELAYS: Alarm	Range: None, Alarm, Aux1, Aux2, or combinations
	LINE ▲	SHORT/LOW TEMP ALARM EVENTS: No	Range: No, Yes

The 369 has an RTD Short/Low Temperature alarm. This function tracks all RTDs that have an application other than “None” to determine if an RTD has either a short or a very low temperature (less than  $-40^{\circ}\text{C}$ ). When a short/low temperature is detected, the assigned output relay will operate and a message will appear on the display identifying the RTD that caused the alarm. It is recommended that if this feature is used, the alarm be programmed as latched so that intermittent RTDs are detected and corrective action may be taken.

### 5.7.6 Loss of RRTD Comms Alarm

PATH: S6 RTD TEMPERATURE ↓↓↓↓↓ LOSS OF RRTD COMMS

LOSS OF RRTD COMMS



LOSS OF RRTD COMMS  
ALARM: OFF

Range: Off, Latched, Unlatched



ASSIGN ALARM RELAYS:  
Alarm

Range: None, Alarm, Aux1, Aux2, or combinations



LOSS OF RRTD COMMS  
EVENTS: No

Range: No, Yes

The 369, if connected to a RRTD module, will monitor communications between them. If for some reason communications is lost or interrupted the 369 can issue an alarm indicating the failure. This feature is useful to ensure that the remote RTDs are continuously being monitored.

## 5.8 S7 Voltage Elements

### 5.8.1 Description

These elements are not used by the 369 unless the M or B option is installed and the **VT CONNECTION TYPE** setpoint (see Section 5.3.2: CT/VT Setup on page –122) is set to something other than “None”.

### 5.8.2 Undervoltage

PATH: S7 VOLTAGE ELEMENTS ▾ UNDERVOLTAGE

UNDERVOLTAGE	ENTER	U/V ACTIVE IF MOTOR STOPPED: No	Range: No, Yes
	LINE ▼	UNDERVOLTAGE ALARM: Off	Range: Off, Latched, Unlatched
	⇅	ASSIGN ALARM RELAYS: Alarm	Range: None, Alarm, Aux1, Aux2 or combinations
	⇅	STARTING U/V ALARM PICKUP: 0.85xRATED	Range: 0.50 to 0.99 × RATED in steps of 0.01
	⇅	RUNNING U/V ALARM PICKUP: 0.85xRATED	Range: 0.50 to 0.99 × RATED in steps of 0.01
	⇅	UNDERVOLTAGE ALARM DELAY: 3.0 S	Range: 0.0 to 255.0 s in steps of 0.1
	⇅	UNDERVOLTAGE ALARM EVENTS: Off	Range: Off, On
	⇅	UNDERVOLTAGE TRIP: Off	Range: Off, Latched, Unlatched
	⇅	ASSIGN TRIP RELAYS: Trip	Range: None, Trip, Aux1, Aux2 or combinations
	⇅	STARTING U/V TRIP PICKUP: 0.80xRATED	Range: 0.50 to 0.99 × RATED in steps of 0.01
	⇅	RUNNING U/V TRIP PICKUP: 0.80xRATED	Range: 0.50 to 0.99 × RATED in steps of 0.01
	LINE ▲	UNDERVOLTAGE TRIP DELAY: 1.0s	Range: 0.0 to 255.0 s in steps of 0.1

If enabled, an undervoltage trip or alarm occurs once the magnitude of either  $V_{ab}$ ,  $V_{bc}$ , or  $V_{ca}$  falls below the running pickup level while running or the starting pickup level while starting, for a period of time specified by the alarm or trip delay (pickup levels are multiples of motor nameplate voltage).

An undervoltage on a running motor with a constant load results in increased current. The relay thermal model typically picks up this condition and provides adequate protection. However, this setpoint may be used in conjunction with time delay to provide additional protection that may be programmed for advance warning by tripping.

The **U/V ACTIVE IF MOTOR STOPPED** setpoint may be used to prevent nuisance alarms or trips when the motor is stopped. If "No" is programmed the undervoltage element will be blocked from operating whenever the motor is stopped (no phase current and starter status indicates breaker or contactor open). If the load is high inertia, it may be desirable to ensure that the motor is tripped off line or prevented from starting in the event of a total loss or decrease in line voltage. Programming "Yes" for the block setpoint will ensure that the motor is tripped and may be restarted only after the bus is re-energized.

A typical application of this feature is with an undervoltage of significant proportion that persists while starting a synchronous motor which may prevent it from coming up to rated speed within the rated time. This undervoltage may be an indication of a system fault. To protect a synchronous motor from being restarted while out of step it may be necessary to use undervoltage to take the motor offline before a reclose is attempted.

### 5.8.3 Overvoltage

**PATH: S7 VOLTAGE ELEMENTS ⇓⇓ OVERVOLTAGE**

<b>OVERVOLTAGE</b>		<b>OVERVOLTAGE ALARM: Off</b>	<i>Range: Off, Latched, Unlatched</i>
		<b>ASSIGN ALARM RELAYS: Alarm</b>	<i>Range: None, Alarm, Aux1, Aux2 or combinations</i>
	⇕	<b>OVERVOLTAGE ALARM PICKUP: 1.05xRATED</b>	<i>Range: 1.01 to 1.25 x RATED in steps of 0.01</i>
	⇕	<b>OVERVOLTAGE ALARM DELAY: 3.0s</b>	<i>Range: 0.0 to 255.0 s in steps of 0.1</i>
	⇕	<b>OVERVOLTAGE ALARM EVENTS: Off</b>	<i>Range: Off, On</i>
	⇕	<b>OVERVOLTAGE TRIP: Off</b>	<i>Range: Off, Latched, Unlatched</i>
	⇕	<b>ASSIGN TRIP RELAYS: Trip</b>	<i>Range: None, Trip, Aux1, Aux2, or combinations</i>
	⇕	<b>OVERVOLTAGE TRIP PICKUP: 1.10xRATED</b>	<i>Range: 1.01 to 1.25 x RATED in steps of 0.01</i>
		<b>OVERVOLTAGE TRIP DELAY: 1.0s</b>	<i>Range: 0.0 to 255.0 s in steps of 0.1</i>

If enabled, once the magnitude of either  $V_{ab}$ ,  $V_{bc}$ , or  $V_{ca}$  rises above the Pickup Level for a period of time specified by the Delay, a trip or alarm will occur (pickup levels are multiples of motor nameplate voltage).

An overvoltage on running motor with a constant load will result in decreased current. However, iron and copper losses increase, causing an increase in motor temperature. The current overload relay will not pickup this condition and provide adequate protection. Therefore, the overvoltage element may be useful for protecting the motor in the event of a sustained overvoltage condition.



**The Undervoltage and Overvoltage alarms and trips are activated based upon the phase to phase voltage regardless of the VT connection type.**

## 5.8.4 Phase Reversal

PATH: S7 VOLTAGE ELEMENTS ⇓⇓⇓ PHASE REVERSAL

PHASE REVERSAL	ENTER	PHASE REVERSAL TRIP: Off	<i>Range: Off, Latched, Unlatched</i>
	LINE ▼	ASSIGN TRIP RELAYS: Trip	<i>Range: None, Trip, Aux1, Aux2, or combinations</i>

The 369 Relay can detect reversed phases on the motor. When enabled, this element detects the phase sequence of both the three-phase voltages and the three-phase currents as measured by the relay. If the measured three-phase voltages are greater than 50% of the motor rated voltage the Phase Reversal element will ignore the currents and perform only voltage phase reversal detection.

If the three-phase voltages are not greater than 50% of the motor rated voltage, or voltages are not available on relay terminals, the Phase reversal element will be activated after the measured currents are above 5% of the motor FLA. When the Two-speed Motor feature is enabled, and Speed 1 is active, the Phase Reversal element will be activated when currents are greater than 5% FLA of the Speed 1 FLA setpoint. When Speed 2 is active, the Phase Reversal element will be activated after the currents become greater than 5% FLA of the Speed 2 FLA setpoint.

The element detects the phase reversal condition within 500-700ms and will issue a trip and block the motor start.

The setting of the phase sequence under **S2 SYSTEM SETUP/ CT/VT SETUP/SYSTEM PHASE SEQUENCE** should match the phase sequence of the three-phase voltages measured on the relay terminals. For Two-Speed Motor applications, the setting under **S2 SYSTEM SETUP/ CT/VT SETUP/SYSTEM PHASE SEQUENCE** should match the phase sequence of the currents measured by the relay terminals when in Speed 1.

If the Two-Speed Motor feature is used for Forward and Reverse motor applications, the setting of the phase sequence under **S2 SYSTEM SETUP/CT/VT SETUP/SPEED2 SYSTEM PHASE SEQUENCE** will be opposite to the setting of the phase sequence under **S2 SYSTEM SETUP/ CT/VT SETUP/SYSTEM PHASE SEQUENCE**.

When the voltage phase reversal detection is active, the phase rotation of the measured voltages is compared only to **S2 SYSTEM SETUP/ CT/VT SETUP/SYSTEM PHASE SEQUENCE** setting, whether the Two-Speed Motor feature is enabled or not.



NOTE

If the two-speed feature is used for Forward/Reverse motor applications, the phase sequence of VT input to the 369 and the **SYSTEM PHASE SEQUENCE** setpoint in the 369 relay must match the phase sequence required for Forward rotation of the motor. For correct operation of Phase Reversal trip, the phase sequence of the VT input connections should not be altered in reverse rotation of the motor.

When the phase reversal detection based on currents is active, the phase rotation of the measured currents is compared to **S2 SYSTEM SETUP/ CT/VT SETUP/SYSTEM PHASE SEQUENCE** setting when in Speed 1, and to **S2 SYSTEM SETUP/CT/VT SETUP/SPEED2 SYSTEM PHASE SEQUENCE**, when in Speed 2.

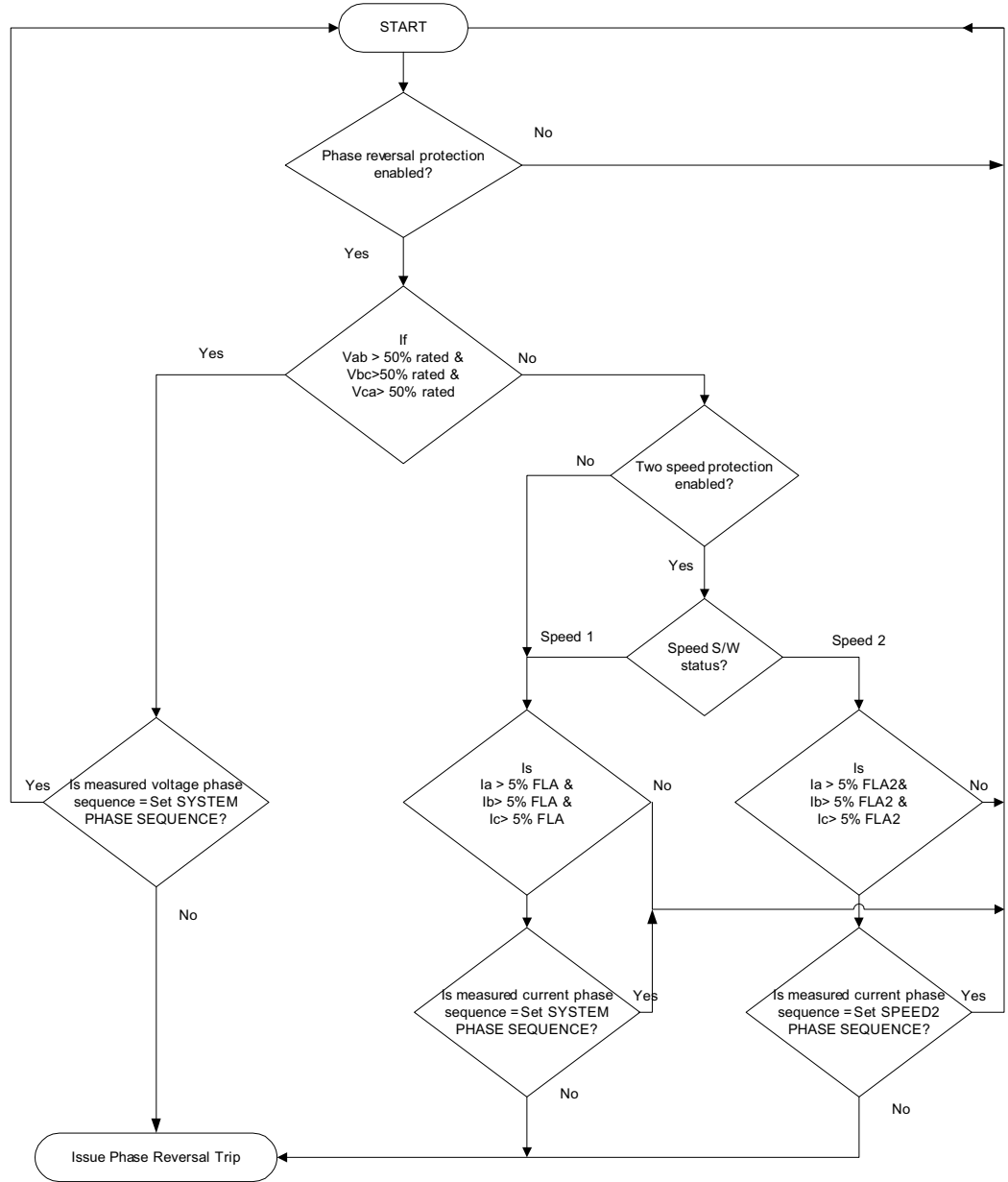

## 5.8.5 Underfrequency

PATH: S7 VOLTAGE ELEMENTS  $\Downarrow\Downarrow\Downarrow\Downarrow$  UNDERFREQUENCY

UNDERFREQUENCY	ENTER	BLOCK UNDERFREQUENCY FROM START:	Range: 0 to 5000 s in steps of 1
	LINE ▼	UNDERFREQUENCY ALARM: Off	Range: Off, Latched, Unlatched
	↕	ASSIGN ALARM RELAYS: Alarm	Range: None, Alarm, Aux1, Aux2, or combinations
	↕	UNDERFREQUENCY ALARM LEVEL: 59.50 Hz	Range: 20.00 to 70.00 Hz in steps of 0.01
	↕	UNDERFREQUENCY ALARM DELAY: 1.0s	Range: 0.0 to 255.0 s in steps of 0.1
	↕	UNDERFREQUENCY ALARM EVENTS: Off	Range: Off, On
	↕	UNDERFREQUENCY TRIP: Off	Range: Off, Latched, Unlatched
	↕	ASSIGN TRIP RELAYS: Trip	Range: None, Trip, Aux1, Aux2, or combinations
	↕	UNDERFREQUENCY TRIP LEVEL: 59.50 Hz	Range: 20.00 to 70.00 Hz in steps of 0.01
	LINE ▲	UNDERFREQUENCY TRIP DELAY: 1.0s	Range: 0.0 to 255.0 s in steps of 0.1

Once the frequency of the phase AN or AB voltage (depending on wye or delta connection) falls below the underfrequency pickup level, a trip or alarm will occur.

This feature may be useful for load shedding applications on large motors. It could also be used to load shed an entire feeder if the trip was assigned to an upstream breaker. Underfrequency can also be used to detect loss of power to a synchronous motor. Due to motor generation, sustained voltage may prevent quick detection of power loss. Therefore, to quickly detect the loss of system power, the decaying frequency of the generated voltage as the motor slows can be used.

The Underfrequency element is not active when the motor is stopped.

### 5.8.6 Overfrequency

PATH: S7 VOLTAGE ELEMENTS ↓↓↓↓ OVERFREQUENCY

<b>OVERFREQUENCY</b>	ENTER	<b>BLOCK OVERFREQUENCY FROM START: 1 s</b>	<i>Range: 0 to 5000 s in steps of 1</i>
	▼	<b>OVERFREQUENCY ALARM: Off</b>	<i>Range: Off, Latched, Unlatched</i>
	⇅	<b>ASSIGN ALARM RELAYS: Alarm</b>	<i>Range: None, Alarm, Aux1, Aux2, or combinations</i>
	⇅	<b>OVERFREQUENCY ALARM LEVEL: 60.50 Hz</b>	<i>Range: 20.00 to 70.00 Hz in steps of 0.01</i>
	⇅	<b>OVERFREQUENCY ALARM DELAY: 1.0s</b>	<i>Range: 0.0 to 255.0 s in steps of 0.1</i>
	⇅	<b>OVERFREQUENCY ALARM EVENTS: Off</b>	<i>Range: Off, On</i>
	⇅	<b>OVERFREQUENCY TRIP: Off</b>	<i>Range: Off, Latched, Unlatched</i>
	⇅	<b>ASSIGN TRIP RELAYS: Trip</b>	<i>Range: None, Trip, Aux1, Aux2, or combinations</i>
	⇅	<b>OVERFREQUENCY TRIP LEVEL: 60.50 Hz</b>	<i>Range: 20.00 to 70.00 Hz in steps of 0.01</i>
	▲	<b>OVERFREQUENCY TRIP DELAY: 1.0s</b>	<i>Range: 0.0 to 255.0 s in steps of 0.1</i>

Once the frequency of the phase AN or AB voltage (depending on wye or delta connection) rises above the overfrequency pickup level, a trip or alarm will occur.

This feature may be useful for load shedding applications on large motors. It could also be used to load shed an entire feeder if the trip was assigned to an upstream breaker.

The Overfrequency element is not active when the motor is stopped.



## 5.9 S8 Power Elements

### 5.9.1 Description

These protective elements rely on CTs and VTs being installed and setpoints programmed. The power elements are only used if the 369 has option M or B installed. By convention, an induction motor consumes Watts and vars. This condition is displayed on the 369 as +Watts and +vars. A synchronous motor can consume Watts and vars or consume Watts and generate vars. These conditions are displayed on the 369 as +Watts, +vars, and +Watts, -vars respectively.

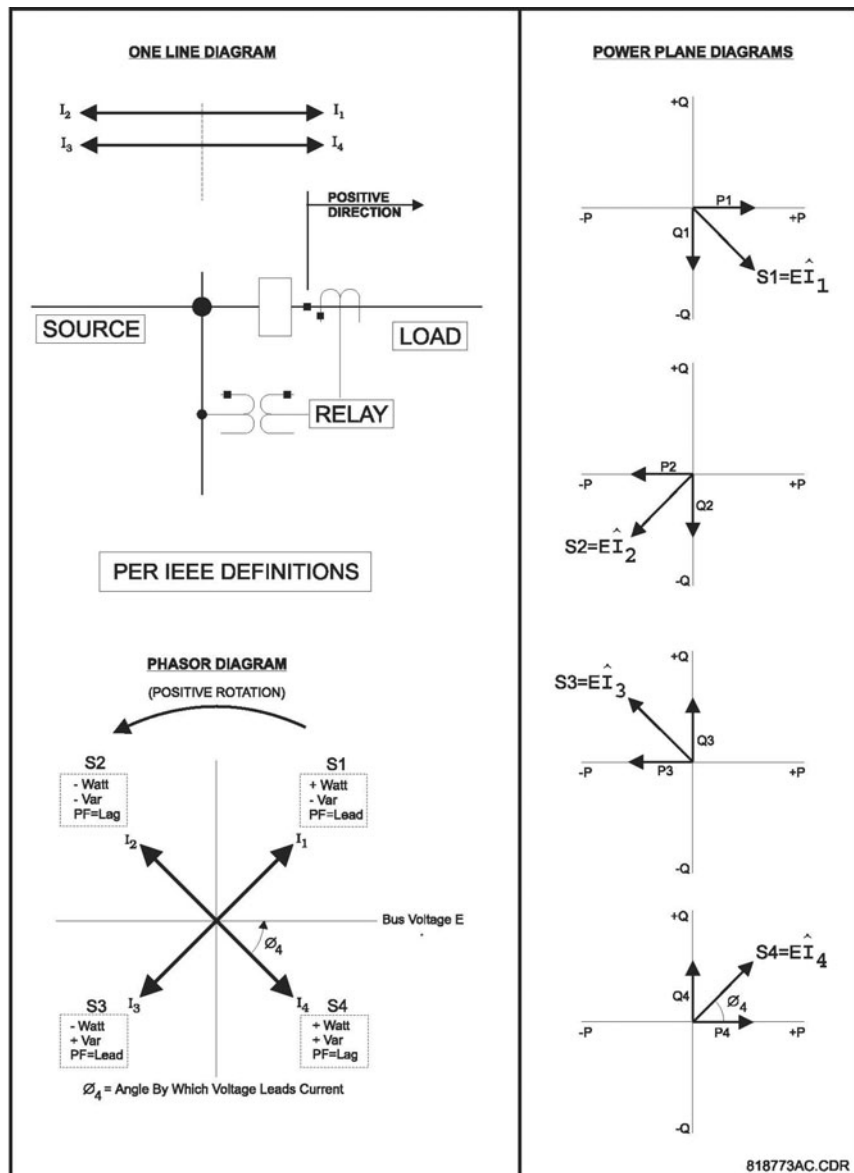

FIGURE 5-12: Power Measurement Conventions

In Two-Speed Motor protection involving Forward/Reverse motor application, in motor reverse direction the phase sequence of the three-phase voltage input is corrected internally for the purpose of power metering. The following power elements may not perform correctly if the phase sequence of the three-phase voltages measured by the relay is different than the **SYSTEM PHASE SEQUENCE** setting:

- LAG POWER FACTOR
- POSITIVE REACTIVE POWER
- NEGATIVE REACTIVE POWER
- UNDERPOWER
- REVERSE POWER

### 5.9.2 Lead Power Factor

**PATH: S8 POWER ELEMENTS ▾ LEAD POWER FACTOR**

<b>LEAD POWER FACTOR</b>	<b>ENTER</b>	<b>BLOCK LEAD PF FROM START: 1 s</b>	<i>Range: 0 to 5000 s in steps of 1</i>
	<b>LINE</b> ▼	<b>LEAD POWER FACTOR ALARM: Off</b>	<i>Range: Off, Latched, Unlatched</i>
	↕	<b>ASSIGN ALARM RELAYS: Alarm</b>	<i>Range: None, Alarm, Aux1, Aux2 or combinations</i>
	↕	<b>LEAD POWER FACTOR ALARM LEVEL: 0.30</b>	<i>Range: 0.05 to 0.99 in steps of 0.01</i>
	↕	<b>LEAD POWER FACTOR ALARM DELAY: 1.0s</b>	<i>Range: 0.1 to 255.0 s in steps of 0.1</i>
	↕	<b>LEAD POWER FACTOR ALARM EVENTS: Off</b>	<i>Range: Off, On</i>
	↕	<b>LEAD POWER FACTOR TRIP: Off</b>	<i>Range: Off, Latched, Unlatched</i>
	↕	<b>ASSIGN TRIP RELAYS: Trip</b>	<i>Range: None, Trip, Aux1, Aux2 or combinations</i>
	↕	<b>LEAD POWER FACTOR TRIP LEVEL: 0.30</b>	<i>Range: 0.05 to 0.99 in steps of 0.01</i>
	<b>LINE</b> ▲	<b>LEAD POWER FACTOR TRIP DELAY: 1.0s</b>	<i>Range: 0.1 to 255.0 s in steps of 0.1</i>

If the 369 is applied on a synchronous motor, it is desirable not to trip or alarm on power factor until the field has been applied. Therefore, this feature can be blocked until the motor comes up to speed and the field is applied. From that point forward, the power factor trip and alarm elements will be active. Once the power factor is less than the lead level, for the specified delay, a trip or alarm will occur indicating a lead condition.

The lead power factor alarm can be used to detect over-excitation or loss of load.

### 5.9.3 Lag Power Factor

#### PATH: S8 POWER ELEMENTS ↕ ↕ LAG POWER FACTOR

LAG POWER FACTOR	ENTER	BLOCK LAG PF FROM START: 1 s	Range: 0 to 5000 s in steps of 1
	LINE	LAG POWER FACTOR ALARM: Off	Range: Off, Latched, Unlatched
	↕	ASSIGN ALARM RELAYS: Alarm	Range: None, Alarm, Aux1, Aux2, or combinations
	↕	LAG POWER FACTOR ALARM LEVEL: 0.85	Range: 0.05 to 0.99 in steps of 0.01
	↕	LAG POWER FACTOR ALARM DELAY: 1.0s	Range: 0.1 to 255.0 s in steps of 0.1
	↕	LAG POWER FACTOR ALARM EVENTS: Off	Range: Off, On
	↕	LAG POWER FACTOR TRIP: Off	Range: Off, Latched, Unlatched
	↕	ASSIGN TRIP RELAYS: Trip	Range: None, Trip, Aux1, Aux2 or combinations
	↕	LAG POWER FACTOR TRIP LEVEL: 0.80	Range: 0.05 to 0.99 in steps of 0.01
	LINE	LAG POWER FACTOR TRIP DELAY: 1.0s	Range: 0.1 to 255.0 s in steps of 0.1

If the 369 is applied on a synchronous motor, it is desirable not to trip or alarm on power factor until the field has been applied. Therefore, this feature can be blocked until the motor comes up to speed and the field is applied. From that point forward, the power factor trip and alarm elements will be active. Once the power factor is less than the lag level, for the specified delay, a trip or alarm will occur indicating lag condition.

The power factor alarm can be used to detect loss of excitation and out of step for a synchronous motor.

### 5.9.4 Positive Reactive Power

#### PATH: S8 POWER ELEMENTS ↕ ↕ ↕ POSITIVE REACTIVE POWER

POSITIVE REACTIVE POWER (kvar)	ENTER	BLOCK +kvar ELEMENT FROM START: 1 s	Range: 0 to 5000 s in steps of 1
	LINE	POSITIVE kvar ALARM: Off	Range: Off, Latched, Unlatched
	↕	ASSIGN ALARM RELAYS: Alarm	Range: None, Alarm, Aux1, Aux2 or combinations
	↕	POSITIVE kvar ALARM LEVEL: 10 kvar	Range: 1 to 25000 kvar in steps of 1
	↕	POSITIVE kvar ALARM DELAY: 1.0 s	Range: 0.1 to 255.0 s in steps of 0.1

⇅	POSITIVE kvar ALARM EVENTS: Off	Range: Off, On
⇅	POSITIVE kvar TRIP:	Range: Off, Latched, Unlatched
⇅	ASSIGN TRIP RELAYS: Trip	Range: None, Trip, Aux1, Aux2 or combinations
⇅	POSITIVE kvar TRIP LEVEL: 25 kvar	Range: 1 to 25000 kvar in steps of 1
▲ LINE	POSITIVE kvar TRIP DELAY: 1.0 s	Range: 0.1 to 255.0 s in steps of 0.1

If the 369 is applied on a synchronous motor, it is desirable not to trip or alarm on kvar until the field has been applied. Therefore, this feature can be blocked until the motor comes up to speed and the field is applied. From that point forward, the kvar trip and alarm elements will be active. Once the kvar level exceeds the positive level, for the specified delay, a trip or alarm will occur indicating a positive kvar condition. The reactive power alarm can be used to detect loss of excitation and out of step.

### 5.9.5 Negative Reactive Power

PATH: S8 POWER ELEMENTS ↓↓↓↓ NEGATIVE REACTIVE POWER

NEGATIVE REACTIVE POWER (kvar)	ENTER	BLOCK -kvar ELEMENT FROM START: 1 s	Range: 0 to 5000 s in steps of 1
	▼ LINE	NEGATIVE kvar ALARM: Off	Range: Off, Latched, Unlatched
	⇅	ASSIGN ALARM RELAYS: Alarm	Range: None, Alarm, Aux1, Aux2, or combinations
	⇅	NEGATIVE kvar ALARM LEVEL: 10 kvar	Range: 1 to 25000 kvar in steps of 1
	⇅	NEGATIVE kvar ALARM DELAY: 1.0 s	Range: 0.1 to 255.0 s in steps of 0.1
	⇅	NEGATIVE kvar ALARM EVENTS: Off	Range: Off, On
	⇅	NEGATIVE kvar TRIP: Off	Range: Off, Latched, Unlatched
	⇅	ASSIGN TRIP RELAYS: Trip	Range: None, Trip, Aux1, Aux2, or combinations
	⇅	NEGATIVE kvar TRIP LEVEL: 25 kvar	Range: 1 to 25000 kvar in steps of 1
	▲ LINE	NEGATIVE kvar TRIP DELAY: 1.0s	Range: 0.1 to 255.0 s in steps of 0.1

When using the 369 on a synchronous motor, it is desirable not to trip or alarm on kvar until the field has been applied. As such, this feature can be blocked until the motor comes up to speed and the field is applied. From that point forward, the kvar trip and alarm

elements will be active. Once the kvar level exceeds the negative level for the specified delay, a trip or alarm occurs, indicating a negative kvar condition. The reactive power alarm can be used to detect overexcitation or loss of load.

### 5.9.6 Underpower

PATH: S8 POWER ELEMENTS ↓↓↓↓↓ UNDERPOWER

UNDERPOWER	ENTER	BLOCK UNDERPOWER FROM START: 1 s	Range: 0 to 15000 s in steps of 1
	▼	UNDERPOWER ALARM: Off	Range: Off, Latched, Unlatched
	↕	ASSIGN ALARM RELAYS: Alarm	Range: None, Alarm, Aux1, Aux2 or combinations
	↕	UNDERPOWER ALARM LEVEL: 2 kW	Range: 1 to 25000 kW in steps of 1
	↕	UNDERPOWER ALARM DELAY: 1 s	Range: 0.5 to 255.0 s in steps of 0.5
	↕	UNDERPOWER ALARM EVENTS: Off	Range: Off, On
	↕	UNDERPOWER TRIP: Off	Range: Off, Latched, Unlatched
	↕	ASSIGN TRIP RELAYS: Trip	Range: None, Trip, Aux1, Aux2, or combinations
	↕	UNDERPOWER TRIP LEVEL: 1 kW	Range: 1 to 25000 kW in steps of 1
	▲	UNDERPOWER TRIP DELAY: 1 s	Range: 0.5 to 255.0 s in steps of 0.5

If enabled, a trip or alarm occurs when the magnitude of three-phase total real power falls below the pickup level for a period of time specified by the delay. The underpower element is active only when the motor is running and will be blocked upon the initiation of a motor start for a period of time defined by the **BLOCK UNDERPOWER FROM START** setpoint (e.g. this block may be used to allow pumps to build up head before the underpower element trips or alarms). A value of 0 means the feature is not blocked from start; otherwise the feature is disabled when the motor is stopped and also from the time a start is detected until the time entered expires. The pickup level should be set lower than motor loading during normal operations.

Underpower may be used to detect loss of load conditions. Loss of load conditions will not always cause a significant loss of current. Power is a more accurate representation of loading and may be used for more sensitive detection of load loss or pump cavitation. This may be especially useful for detecting process related problems.

## 5.9.7 Reverse Power

PATH: S8 POWER ELEMENTS ↓↓↓↓↓ REVERSE POWER

REVERSE POWER	ENTER	BLOCK REVERSE POWER FROM START: 1 s	<i>Range: 0 to 50000 s in steps of 1</i>
	LINE ▼	REVERSE POWER ALARM: Off	<i>Range: Off, Latched, Unlatched</i>
	↕	ASSIGN ALARM RELAYS: Alarm	<i>Range: None, Alarm, Aux1, Aux2, or combination</i>
	↕	REVERSE POWER ALARM LEVEL: 1 kW	<i>Range: 1 to 25000 kW in steps of 1</i>
	↕	REVERSE POWER ALARM DELAY: 1.0 s	<i>Range: 0.5 to 30.0 s in steps of 0.5</i>
	↕	REVERSE POWER ALARM EVENTS: Off	<i>Range: Off, On</i>
	↕	REVERSE POWER TRIP: Off	<i>Range: Off, Latched, Unlatched</i>
	↕	ASSIGN TRIP RELAYS: Trip	<i>Range: None, Trip, Aux1, Aux2, or combinations</i>
	↕	REVERSE POWER TRIP LEVEL: 1 kW	<i>Range: 1 to 25000 kW in steps of 1</i>
	LINE ▲	REVERSE POWER TRIP DELAY: 1.0 s	<i>Range: 0.5 to 30 s in steps of 0.5</i>

If enabled, once the magnitude of three-phase total real power exceeds the pickup level in the reverse direction (negative kW) for a period of time specified by the delay, a trip or alarm will occur.



NOTE

The minimum power measurement magnitude is determined by the phase CT minimum of 5% rated CT primary. If the reverse power level is set below this, a trip or alarm will only occur once the phase current exceeds the 5% cutoff.

## 5.10 S9 Digital Inputs

### 5.10.1 Digital Input Functions

#### Description

Any of the digital inputs may be selected and programmed as a separate General Switch, Digital Counter, or Waveform Capture Input. The **xxxxx** term in the following menus refers to the configurable switch input function – either the Spare Switch, Emergency Restart, Differential Switch, Speed Switch, or Remote Reset inputs described in the following sections.

#### General

<b>xxxxxx SW FUNCTION:</b> General		<b>GENERAL SWITCH</b> <b>NAME: General</b>	Range: 12 character alphanumeric Only seen if function is selected as General
MESSAGE	↕	<b>GENERAL SWITCH</b> <b>TYPE: NO</b>	Range: NO (normally open), NC (normally closed) Only seen if function is selected as General
MESSAGE	↕	<b>BLOCK INPUT FROM</b> <b>START: 0 s</b>	Range: 0 to 5000 s in steps of 1 Only seen if function is selected as General
MESSAGE	↕	<b>GENERAL SWITCH</b> <b>ALARM: Off</b>	Range: Off, Latched, Unlatched Only seen if function is selected as General
MESSAGE	↕	<b>ASSIGN ALARM RELAYS:</b> <b>Alarm</b>	Range: None, Alarm, Aux1, Aux2, or combinations Only seen if function is selected as General
MESSAGE	↕	<b>GENERAL SWITCH</b> <b>ALARM DELAY: 5.0 s</b>	Range: 0.1 to 5000.0 s in steps of 0.1 Only seen if function is selected as General
MESSAGE	↕	<b>RECORD ALARMS AS</b> <b>EVENTS: No</b>	Range: No, Yes Only seen if function is selected as General
MESSAGE	↕	<b>GENERAL SWITCH</b> <b>TRIP: Off</b>	Range: Off, Latched, Unlatched Only seen if function is selected as General
MESSAGE	↕	<b>ASSIGN TRIP RELAYS:</b> <b>Trip</b>	Range: None, Trip, Aux1, Aux2, or combinations Only seen if function is selected as General
MESSAGE		<b>GENERAL SWITCH</b> <b>TRIP DELAY: 5.0 s</b>	Range: 0.1 to 5000.0 s in steps of 0.1 Only seen if function is selected as General









GENERAL SWITCH NAME can not be edited using front panel. EnerVista 369 Setup software should be used to set the GENERAL SWITCH NAME.

The above selections will be shown if the in the corresponding menu if **SPARE SW FUNCTION**, **EMERGENCY FUNCTION**, **DIFF SW FUNCTION**, or **SPEED SW FUNCTION** setpoints are set to “General”. Refer to the individual sections for Spare Switch, Emergency Restart, Differential Switch, Speed Switch, or Remote Reset below for additional function-specific setpoints.



## Digital Counter

<b>xxxxx SW FUNCTION:</b> <b>Digital Counter</b>		<b>COUNTER</b> <b>NAME: Counter</b>	Range: 8 character alphanumeric Only seen if function is Digital Counter
MESSAGE		<b>COUNTER</b> <b>UNITS: Units</b>	Range: 6 character alphanumeric Only seen if function is Digital Counter
MESSAGE		<b>COUNTER</b> <b>TYPE: Increment</b>	Range: Increment, Decrement Only seen if function is Digital Counter
MESSAGE		<b>DIGITAL COUNTER</b> <b>ALARM: Off</b>	Range: Off, Latched, Unlatched Only seen if function is Digital Counter
MESSAGE		<b>ASSIGN ALARM RELAYS:</b> <b>Alarm</b>	Range: None, Alarm, Aux1, Aux2, or combinations. Only seen if function is Digital Counter
MESSAGE		<b>COUNTER ALARM LEVEL:</b> <b>100</b>	Range: 0 to 65535 in steps of 1 Only seen if function is Digital Counter
MESSAGE		<b>RECORD ALARMS AS</b> <b>EVENTS: No</b>	Range: No, Yes Only seen if function is Digital Counter

The above selections will be shown if the **SPARE SW FUNCTION, EMERGENCY FUNCTION, DIFF SW FUNCTION, or SPEED SW FUNCTION** setpoints are set to “Digital Counter”. Refer to the individual sections for Spare Switch, Emergency Restart, Differential Switch, Speed Switch, or Remote Reset below for additional function-specific setpoints.

Only one digital input may be selected as a digital counter at a time. User defined units and counter name may be defined and these will appear on all counter related actual value and alarm messages. To clear a digital counter alarm, the alarm level must be increased or the counter must be cleared or preset to a lower value.

## Waveform Capture



The Waveform Capture setting for the digital inputs allows the 369 to capture a waveform upon command (contact closure). The captured waveforms can then be displayed via the EnerVista 369 Setup program.

## DeviceNet Control

This function is available for the DeviceNet option only. The digital input set with the DeviceNet control function and the switch status closed allows motor start, motor stop, and fault reset commands through DeviceNet communications.

### 5.10.2 Spare Switch

PATH: S9 DIGITAL INPUTS ↓ SPARE SWITCH

<b>SPARE SWITCH</b>		 <b>SPARE SW FUNCTION:</b> Off	Range: Off, Starter Status, General, Digital Counter, Waveform Capture, DeviceNet Control
MESSAGE	⇕	<b>STARTER AUX CONTACT</b> TYPE: 52a	Range: 52a, 52b Only seen if FUNCTION is "Starter Status"
MESSAGE	⇕	<b>STARTER OPERATION</b> MONITOR DELAY: 3 s	Range: OFF, 0 to 60 s in steps of 1 Only seen if FUNCTION is "Starter Status"
MESSAGE	⇕	<b>STARTER OPERATION</b> TYPE: Off	Range: Off, Latched, Unlatched. Only seen if <b>SPARE SW FUNCTION</b> is "Starter Status" and <b>STARTER OPERATION MONITOR</b>
MESSAGE		<b>ASSIGN RELAYS:</b> None	Range: None, Trip, Alarm, Aux1, Aux2, or combinations. Only seen if <b>SPARE SW FUNCTION</b> is "Starter Status" and <b>STARTER OPERATION MONITOR DELAY</b> is not "Off".

See Section 5.10.1: Digital Input Functions for an explanation of the spare switch functions.

It is recommended that the auxiliary contact from the main breaker for starter status monitoring is wired to the Spare Switch digital input terminals 51 and 52 for the following reasons:

- To avoid undesired operation of START/INHIBIT elements during speed switching.
- To ensure applying the **SPEED2 ACCEL. TIMER FROM 1-2**, when switched from Speed 1 to Speed 2. If the breaker status is not monitored, the 369 relay may detect **MOTOR STOPPED** status, and apply **ACCEL. TIMER FROM START**, when switching to Speed 2.
- To ensure Learned values such as Learned Starting Thermal Capacity, Learned Starting Current, and Learned Acceleration Time, are correctly calculated irrespective of speed switching.

In addition to regular selections, the Spare Switch may be used as a starter status contact input. An auxiliary '52a' type contact follows the state of the main contactor or breaker and an auxiliary '52b' type contact is in the opposite state. This feature is recommended for use on all motors. It is essential for proper operation of start inhibits (i.e., starts/hour, time between starts, start inhibit, restart block, backspin start inhibit), especially when the motor may be run lightly or unloaded.

A motor stop condition is detected when the current falls below 5% of CT. When **SPARE SWITCH** is programmed as "Starter Status", motor stop conditions are detected when the current falls below 5% of CT **and** the breaker is open. Enabling the Starter Status and wiring the breaker contactor to the Spare Switch eliminates nuisance lockouts initiated by the 369 if the motor (synchronous or induction) is running unloaded or idling, and if the **STARTS/HOUR, TIME BETWEEN STARTS, START INHIBIT, RESTART BLOCK, and BACKSPIN START INHIBIT** are programmed.

In addition, there may be applications where current is briefly present after the breaker is opened on a motor stop (for example, discharge from power factor correction capacitors). In such a case, the 369 will detect this current as an additional start. To prevent this from occurring, the **STARTER OPERATION MONITOR DELAY** setpoint is used. If this setpoint is programmed to any value other than "OFF", a motor start is logged only if current above

5% of the CT is present *and* the breaker is closed (for an “52a” type contact). If the breaker is open (for an “52a” type contact) and the current above 5% of CT is present for longer than the **STARTER OPERATION MONITOR DELAY** time, then a trip or alarm will occur (according to the relay settings). If the trip relay is assigned under the **ASSIGN RELAYS** setpoint, then a trip will occur and a trip event will be recorded; otherwise, an alarm will occur and an alarm event recorded. If the **STARTER OPERATION MONITOR DELAY** is “OFF”, this functionality will be disabled.



The Access switch is predefined and is non programmable.

### 5.10.3 Emergency Restart

PATH: S9 DIGITAL INPUTS ⇓⇓ EMERGENCY RESTART

<b>EMERGENCY RESTART</b>		<b>EMERGENCY FUNCTION:</b> <b>Emergency Restart</b>	<i>Range: Off, Emergency Restart, General, Digital Counter, Waveform Capture, DeviceNet Control, Speed Switch<sup>1</sup></i>
--------------------------	--	--	---

1.Shown only if two-speed motor protection is enabled

See Section 5.10.1: *Digital Input Functions on page –184* for an explanation of the emergency restart functions. In addition to the normal selections, the Emergency Restart Switch may be used as a emergency restart input to the 369 to override protection for the motor.

When the emergency restart switch is closed all trip and alarm functions are reset. Thermal capacity used is set to zero and all protective elements are disabled until the switch is opened. Starts per hour are also reduced by one each time the switch is closed.

	<b>SPEED SWITCH TIME</b> <b>DELAY: 2.0 s</b>	<i>Range: 0.5 to 100.0 seconds in steps of 0.5 s Only seen if FUNCTION is "Speed Switch"</i>
	<b>SPEED SW TRIP RELAY:</b> <b>Trip</b>	<i>Range: None, Trip, Aux1, Aux 2, or combinations Only seen if FUNCTION is "Speed Switch"</i>

Refer to 5.10.5: *Speed Switch* for setting details. The Speed switch function uses the input from terminals 55-56, but applies different Speed Switch Time Delays for Speed 1 and Speed 2. Refer to section 5.13.4: *Speed 2 Acceleration* for the Speed 2 Speed Switch time delay setting



### 5.10.4 Differential Switch

PATH: S9 DIGITAL INPUTS ⇓⇓⇓ DIFFERENTIAL SWITCH

<b>DIFFERENTIAL SWITCH</b>		<b>DIFF SW FUNCTION:</b> <b>Differential Switch</b>	<i>Range: Off, Differential Switch, General, Digital Counter, Waveform Capture, DeviceNet Control, Speed Switch<sup>1</sup>.</i>
		<b>DIFF SW TRIP RELAY:</b> <b>Trip</b>	<i>Range: None, Trip, Aux1, Aux2 or combinations Only seen if FUNCTION is "Differential Switch".</i>

1.Shown only if two-speed motor protection is enabled



See Section 5.10.1: *Digital Input Functions on page -184* for an explanation of differential switch functions. In addition to the normal selections, the Differential Switch may be used as a contact input for a separate external 86 (differential trip) relay. Contact closure will cause the 369 relay to issue a differential trip.

	<b>SPEED SWITCH TIME</b> <b>DELAY: 2.0 s</b>	<i>Range: 0.5 to 100.0 seconds in steps of 0.5 s</i> <i>Only seen if FUNCTION is "Speed Switch"</i>
	<b>SPEED SW TRIP RELAY:</b> <b>Trip</b>	<i>Range: None, Trip, Aux1, Aux 2, or combinations</i> <i>Only seen if FUNCTION is "Speed Switch"</i>

Refer to 5.10.5: *Speed Switch* for setting details. The Speed switch function uses the input from terminals 55-56, but applies different Speed Switch Time Delays for Speed 1 and Speed 2. Refer to section 5.13.4: *Speed 2 Acceleration* for the Speed 2 Speed Switch time delay setting

### 5.10.5 Speed Switch

**PATH: S9 DIGITAL INPUTS ↓↓↓↓ SPEED SWITCH**

SPEED SWITCH		<b>SPEED SW FUNCTION:</b> <b>Speed Switch</b>	<i>Range: Off, Speed Switch, General, Digital Counter, Waveform Capture, DeviceNet Control</i>
		<b>SPEED SWITCH TIME</b> <b>DELAY: 2.0s</b>	<i>Range: 0.5 to 100.0s in steps of 0.5</i> <i>Only seen if FUNCTION is "Speed Switch"</i>
		<b>SPEED SW TRIP RELAY:</b> <b>Trip</b>	<i>Range: None, Trip, Aux1, Aux2 or combinations</i> <i>Only seen if FUNCTION is "Speed Switch"</i>

See Section 5.10.1: *Digital Input Functions* for an explanation of Speed Switch functions. In addition to the normal selections, the Speed Switch may be used as an input for an external Speed Switch. This allows the 369 to utilize a speed device for locked rotor protection. During a motor start, if no contact closure occurs within the programmed time delay, a trip will occur. The speed input must be opened for a Speed Switch trip to be reset

SPEED SWITCH		<b>SPEED SW FUNCTION:</b> <b>Two Speed Monitor</b>
--------------	---	---

Upon enabling the 2-speed motor application (**ENABLE TWO-SPEED MOTOR = Yes**), this input is no longer programmable but signifies the motor speed at any given time. "Open" is recognized as Speed 1, and "closed" is recognized as Speed 2. The Speed Switch (terminals 55-56) is automatically designated for two-speed motor protection and will display message "Two Speed Monitor". Under this application, the switch cannot be assigned to perform any other function.

The 369 relay monitors the following five stages of the motor: "Stopped", "Starting", "Running", "Overload", and "Tripped". Flow chart on status detection for single speed motor application is found under **APPLICATIONS/MOTOR STATUS DETECTION** chapter of this manual.

To determine the status of the two-speed motor when switching in Speed 1, Speed 2, Speed 1-2, or from Speed 2-1, the relay uses the following information: Breaker status – auxiliary contact wired to relay’s Spare Switch terminals 51-52, output from motor’s Speed 2 contactor wired to Speed Switch terminals 55-56, and motor phase currents.

For motor status detection when switching from start in Speed 2, refer to chapter 7.6.1 Motor Status Detection which outlines the motor status, when switching from start in Speed 1.

By maintaining breaker “closed”, and motor status **RUNNING** in Speed 1, switching from Speed 1 to Speed 2 will not change the status of the motor. The relay will still show status **RUNNING**, even when during speed switching, both Speed 1 and Speed 2 contactors are open, and the motor current is below 5% of the CT primary set for Speed 1. Upon detection of Speed Switch contact input “closed”, the relay applies the Speed 2 settings for CT primary and FLA. The **SPEED2 ACCEL TIMER FROM START** and **ACCEL TIMER FROM SPEED 1-2** start upon detection of Speed Switch status “closed”.

### 5.10.6 Remote Reset

**PATH: S9 DIGITAL INPUTS ↓↓↓↓ REMOTE RESET**

<b>REMOTE RESET</b>		<b>REMOTE SW FUNCTION:</b> Remote Reset	<i>Range: Off, Remote Reset, General, Digital Counter, Waveform Capture, DeviceNet Control, Speed Switch<sup>1</sup></i>
---------------------	---	--	--

1.Shown only if two-speed motor protection is enabled.

See the following section for an explanation of remote reset functions. In addition to the normal selections, the Remote Reset may be used as a contact input to reset the relay.

	<b>SPEED SWITCH TIME DELAY:</b> 2.0 s	<i>Range: 0.5 to 100.0 seconds in steps of 0.5 s Only seen if FUNCTION is "Speed Switch"</i>
	<b>SPEED SW TRIP RELAY:</b> Trip	<i>Range: None, Trip, Aux1, Aux 2, or combinations Only seen if FUNCTION is "Speed Switch"</i>

Refer to 5.10.5: *Speed Switch* for setting details. The Speed switch function uses the input from terminals 55-56, but applies different Speed Switch Time Delays for Speed 1 and Speed 2. Refer to section 5.13.4: *Speed 2 Acceleration* for the Speed 2 Speed Switch time delay setting

## 5.11 S10 Analog Outputs

### 5.11.1 Analog Outputs

PATH: S10 ANALOG OUTPUTS ↓ ANALOG OUTPUT 1(4)

ANALOG OUTPUT 1	ENTER	ANALOG OUTPUT 1: DISABLED	Range: Disabled, Enabled
	LINE ▼	ANALOG OUTPUT 1 RANGE: 0-1 mA	Range: 0-1mA, 0-20 mA, 4-20 mA
	⇕	ANALOG OUTPUT 1: Phase A Current	Range: See Analog Output selection table
	⇕	ANALOG OUTPUT 1 MIN: 0 A	Range: See Analog Output selection table
	▲ LINE	ANALOG OUTPUT 1 MAX: 100 A	Range: See Analog Output selection table

The analog output parameters are indicated in the following table:

Table 5-3: Analog Output Parameters

PARAMETER NAME	RANGE /UNITS	STEP	DEFAULT	
			MINIMUM	MAXIMUM
Phase A Current	0 to 65535 A	1	0	100
Phase B Current	0 to 65535 A	1	0	100
Phase C Current	0 to 65535 A	1	0	100
Avg. Phase Current	0 to 65535 A	1	0	100
AB Line Voltage	0 to 65000 V	1	3200	4500
BC Line Voltage	0 to 65000 V	1	3200	4500
CA Line Voltage	0 to 65000 V	1	3200	4500
Avg. Line Voltage	0 to 65000 V	1	3200	4500
Phase AN Voltage	0 to 65000 V	1	1900	2500
Phase BN Voltage	0 to 65000 V	1	1900	2500
Phase CN Voltage	0 to 65000 V	1	1900	2500
Avg. Phase Voltage	0 to 65000 V	1	1900	2500
Hottest Stator RTD	-40 to +200°C or -40 to +392°F	1	0	200
RTD #1 to 12	-40 to +200°C or -40 to +392°F	1	-40	200
Power Factor	-0.99 to 1.00	0.01	0.01	0.80

Table 5-3: Analog Output Parameters

PARAMETER NAME	RANGE /UNITS	STEP	DEFAULT	
			MINIMUM	MAXIMUM
Reactive Power	-32000 to 32000 kvar	1	0	750
Real Power	-32000 to 32000 kW	1	0	1000
Apparent Power	0 to 65000 kVA	1	0	1250
Thermal Capacity Used	0 to 100%	1	0	100
Relay Lockout Time	0 to 999 minutes	1	0	150
Motor Load	0.00 to 20.00 x FLA	0.01	0.00	1.25
MWhrs	0 to 65535 MWhrs	1	0	65535

## 5.12 S11 369 Testing

### 5.12.1 Test Output Relays

PATH: S11 369 TESTING ▾ TEST OUTPUT RELAYS

<b>TEST OUTPUT RELAYS</b>	ENTER	<b>FORCE TRIP RELAY:</b> Disabled	<i>Range: Disabled, Energized, De-energized</i>
	LINE ▼	<b>FORCE TRIP RELAY</b> <b>DURATION: Static</b>	<i>Range: Static, 1 to 300 s in steps of 1</i>
	⇅	<b>FORCE AUX1 RELAY:</b> Disabled	<i>Range: Disabled, Energized, De-energized</i>
	⇅	<b>FORCE AUX1 RELAY</b> <b>DURATION: Static</b>	<i>Range: Static, 1 to 300 s in steps of 1</i>
	⇅	<b>FORCE AUX2 RELAY:</b> Disabled	<i>Range: Disabled, Energized, De-energized</i>
	⇅	<b>FORCE AUX2 RELAY:</b> <b>DURATION: Static</b>	<i>Range: Static, 1 to 300 s in steps of 1</i>
	⇅	<b>FORCE ALARM RELAY:</b> Disabled	<i>Range: Disabled, Energized, De-energized</i>
	LINE ▲	<b>FORCE ALARM RELAY</b> <b>DURATION: Static</b>	<i>Range: Static, 1 to 300 s in steps of 1</i>

The Test Output Relay feature provides a method of performing checks on all relay contact outputs. This feature is not meant for control purposes during operation of the motor. For control purposes, the force output relays functionality (refer to *Force Output Relays* on page 5–139) is used.

The forced state, if enabled (energized or de-energized), forces the selected relay into the programmed state for as long as the programmed duration. After the programmed duration expires, the forced relay will return to its non-forced physical state. The 369 will continue to remain in Test Mode until the "Force Relay" setpoint has been set back to "Disabled" for any relays being tested. If the duration is programmed as Static, the forced state will remain in effect until changed or disabled. If control power to the 369 is interrupted, any forced relay condition will be removed.

When the relays in this feature are programmed to any value other than "Disabled", the In Service LED on the front panel will turn on. This provides notification that the relay is not currently operating in a normal condition.



The OUTPUT STATUS LED on the front display panel of the 369 is lit when the respective output relay is in an energized state.



## 5.12.2 Test Analog Outputs

PATH: S11 369 TESTING ⇅⇅ TEST ANALOG OUTPUTS

TEST ANALOG OUTPUTS	ENTER	FORCE ANALOG OUTPUT 1: Off	Range: Off, 1 to 100% in steps of 1
	LINE ▼	FORCE ANALOG OUTPUT 2: Off	Range: Off, 1 to 100% in steps of 1
	↕	FORCE ANALOG OUTPUT 3: Off	Range: Off, 1 to 100% in steps of 1
	LINE ▲	FORCE ANALOG OUTPUT 4: Off	Range: Off, 1 to 100% in steps of 1

The Test Analog Output setpoints may be used during startup or testing to verify that the analog outputs are functioning correctly. It may also be used when the motor is running to give manual or communication control of an analog output. Forcing an analog output **overrides** its normal functionality.

When the Force Analog Outputs Function is enabled, the output will reflect the forced value as a percentage of the range 4 to 20 mA, 0 to 20 mA, or 0 to 1 mA. Selecting Off will place the analog output channels back in service, reflecting the parameters programmed to each.

## 5.13 S12 Two-speed Motor

### 5.13.1 Description

The two-speed motor feature provides adequate protection for a two-speed motor. This assumes the following values can differ between the two speeds: **SPEED SWITCH** status, CT primary, motor FLA, and the phase sequence. The relay accommodates these differences in the following protection functions: **THERMAL MODEL, OVERLOAD CURVES, OVERLOAD ALARM, SHORT CIRCUIT, MECHANICAL JAM, UNDERCURRENT, CURRENT UNBALANCE,** and **ACCELERATION TRIP.**

In order to utilize this feature the digital inputs signifying motor energization (breaker) and speed are wired as explained under **SETPOINTS/S9 DIGITAL INPUT FUNCTIONS** chapter of this manual. Also, the enable setpoint for this function under **SYSTEM SETUP / CT/VT SETUP/ENABLE 2-SPEED MOTOR** is set to 'Yes', and the fundamental motor parameters as referring to Speeds 1 and 2 are programmed under **SYSTEM SETUP / CT/VT SETUP.**

The Speed 2 settings are provided under the following extra menu and share the same function settings, that is under Speed 2. A given function will respond the same way as under Speed 1.

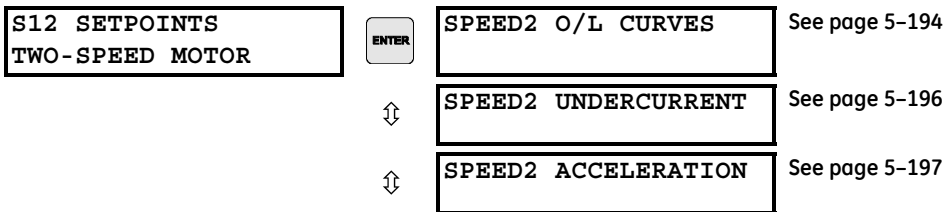

The relay allows for separate settings of the three listed features independently for Speed 1 and Speed 2. Note that the Speed 1 settings are provided under:

**S3 OVERLOAD PROTECTION/THERMAL MODEL** with setting of overload pickup level corresponding to the FLA of Speed 1.

**S3 OVERLOAD PROTECTION/OVERLOAD CURVE** with selection of curve type corresponding to Speed 1 thermal overload,

**S4 CURRENT ELEMENTS/UNDERCURRENT** with settings for undercurrent alarm and trip expressed in times FLA of Speed 1, and

**S5 MOTOR START/INHIBIT/ACCELERATION TRIP** setting of the acceleration timer from start referring to start in Speed 1.

### 5.13.2 Speed 2 Overload Curves

**PATH: S12 TWO-SPEED MOTOR ↓SPEED2 O/L CURVES**

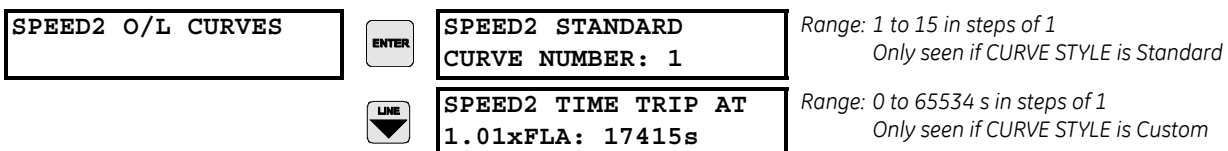

⇕	<b>SPEED2 TIME TRIP AT 1.05xFLA: 3415 s</b>	Range: 0 to 65534 s in steps of 1 Only seen if CURVE STYLE is Custom
⇕	<b>SPEED2 TIME TRIP AT 1.10xFLA: 1667 s</b>	Range: 0 to 65534 s in steps of 1 Only seen if CURVE STYLE is Custom
⇕	<b>SPEED2 TIME TRIP AT 1.20xFLA: 795 s</b>	Range: 0 to 65534 s in steps of 1 Only seen if CURVE STYLE is Custom
⇕	<b>SPEED2 TIME TRIP AT 1.30xFLA: 507 s</b>	Range: 0 to 65534 s in steps of 1 Only seen if CURVE STYLE is Custom
⇕	<b>SPEED2 TIME TRIP AT 1.40xFLA: 365 s</b>	Range: 0 to 65534 s in steps of 1 Only seen if CURVE STYLE is Custom
⇕	<b>SPEED2 TIME TRIP AT 1.50xFLA: 280 s</b>	Range: 0 to 65534 s in steps of 1 Only seen if CURVE STYLE is Custom
⇕	<b>SPEED2 TIME TRIP AT 1.75xFLA: 170 s</b>	Range: 0 to 65534 s in steps of 1 Only seen if CURVE STYLE is Custom
⇕	<b>SPEED2 TIME TRIP AT 2.00xFLA: 117 s</b>	Range: 0 to 65534 s in steps of 1 Only seen if CURVE STYLE is Custom
⇕	<b>SPEED2 TIME TRIP AT 2.25xFLA: 86 s</b>	Range: 0 to 65534 s in steps of 1 Only seen if CURVE STYLE is Custom
⇕	<b>SPEED2 TIME TRIP AT 2.50xFLA: 67 s</b>	Range: 0 to 65534 s in steps of 1 Only seen if CURVE STYLE is Custom
⇕	<b>SPEED2 TIME TRIP AT 2.75xFLA: 53 s</b>	Range: 0 to 65534 s in steps of 1 Only seen if CURVE STYLE is Custom
⇕	<b>SPEED2 TIME TRIP AT 3.00xFLA: 44 s</b>	Range: 0 to 65534 s in steps of 1 Only seen if CURVE STYLE is Custom
⇕	<b>SPEED2 TIME TRIP AT 3.25xFLA: 37 s</b>	Range: 0 to 65534 s in steps of 1 Only seen if CURVE STYLE is Custom
⇕	<b>SPEED2 TIME TRIP AT 3.50xFLA: 31 s</b>	Range: 0 to 65534 s in steps of 1 Only seen if CURVE STYLE is Custom
⇕	<b>SPEED2 TIME TRIP AT 3.75xFLA: 27 s</b>	Range: 0 to 65534 s in steps of 1 Only seen if CURVE STYLE is Custom
⇕	<b>SPEED2 TIME TRIP AT 4.00xFLA: 23 s</b>	Range: 0 to 65534 s in steps of 1 Only seen if CURVE STYLE is Custom
⇕	<b>SPEED2 TIME TRIP AT 4.25xFLA: 21 s</b>	Range: 0 to 65534 s in steps of 1 Only seen if CURVE STYLE is Custom
⇕	<b>SPEED2 TIME TRIP AT 4.50xFLA: 18 s</b>	Range: 0 to 65534 s in steps of 1 Only seen if CURVE STYLE is Custom
⇕	<b>SPEED2 TIME TRIP AT 4.75xFLA: 16 s</b>	Range: 0 to 65534 s in steps of 1 Only seen if CURVE STYLE is Custom
⇕	<b>SPEED2 TIME TRIP AT 5.00xFLA: 15 s</b>	Range: 0 to 65534 s in steps of 1 Only seen if CURVE STYLE is Custom
⇕	<b>SPEED2 TIME TRIP AT 5.50xFLA: 12 s</b>	Range: 0 to 65534 s in steps of 1 Only seen if CURVE STYLE is Custom
⇕	<b>SPEED2 TIME TRIP AT 6.00xFLA: 10 s</b>	Range: 0 to 65534 s in steps of 1 Only seen if CURVE STYLE is Custom

⇅	<b>SPEED2 TIME TRIP AT 6.50xFLA: 9 s</b>	Range: 0 to 65534 s in steps of 1 Only seen if CURVE STYLE is Custom
⇅	<b>SPEED2 TIME TRIP AT 7.00xFLA: 7 s</b>	Range: 0 to 65534 s in steps of 1 Only seen if CURVE STYLE is Custom
⇅	<b>SPEED2 TIME TRIP AT 7.50xFLA: 6 s</b>	Range: 0 to 65534 s in steps of 1 Only seen if CURVE STYLE is Custom
⇅	<b>SPEED2 TIME TRIP AT 8.00xFLA: 6 s</b>	Range: 0 to 65534 s in steps of 1 Only seen if CURVE STYLE is Custom
⇅	<b>SPEED2 TIME TRIP AT 10.0xFLA: 6 s</b>	Range: 0 to 65534 s in steps of 1 Only seen if CURVE STYLE is Custom
⇅	<b>SPEED2 TIME TRIP AT 15.0xFLA: 6 s</b>	Range: 0 to 65534 s in steps of 1 Only seen if CURVE STYLE is Custom
	<b>SPEED2 TIME TRIP AT 20.0xFLA: 6 s</b>	Range: 0 to 65534 s in steps of 1 Only seen if CURVE STYLE is Custom

The overload curve selection for Speed 2 is done identically to the selection for Speed 1 or regular single-speed applications as described under **S3 OVERLOAD PROTECTION** chapter of the manual. The function setting for Speed 1 found under **S3 OVERLOAD PROTECTION** controls the response of the thermal protection under Speed 2 as well. Note that the relay will apply individual CT primary setting, individual FLA and potentially different curve for Speeds 1 and 2. This creates enough flexibility (degrees of freedom) to accommodate the 2-speed applications in a natural way without an awkward workarounds. Note that the thermal model integrates the thermal capacity continuously when switching between the speeds and thus potentially different CT primaries, FLAs and curves.



When two speed motor protection is selected and used for Forward/Reverse motor rotation, it is required that switching between the speeds goes through a stage of no current (motor slows down or stops). Then it is followed by a start in the opposite direction. Switching in opposite direction, while motor is running is not recommended.

### 5.13.3 Speed 2 Undercurrent

PATH: S12 TWO-SPEED MOTOR ↓SPEED2 UNDERCURRENT

<b>SPEED2 UNDERCURRENT</b>		<b>BLOCK SPEED2 U/C FROM START: 0 s</b>	Range: 0 to 15000 seconds in steps of 1
	⇅	<b>SPEED2 U/C ALARM: Off</b>	Range: Off, Latched, Unlatched
	⇅	<b>ASSIGN SPEED2 U/C RELAYS: Alarm</b>	Range: None, Alarm, Aux1, Aux2, or combinations of them
	⇅	<b>SPEED2 U/C ALARM: LEVEL: 0.70 x FLA</b>	Range: 0.10 to 0.99 x FLA in steps of 1
	⇅	<b>SPEED2 U/C ALARM: DELAY: 1 s</b>	Range: 1 to 255 seconds in steps of 1
	⇅	<b>SPEED2 U/C ALARM EVENTS: Off</b>	Range: On, Off

⇅	<b>SPEED2 U/C</b> <b>TRIP: Off</b>	Range: Off, Latched, Unlatched
⇅	<b>ASSIGN SPEED2 U/C</b> <b>RELAYS: Trip</b>	Range: None, Trip, Aux1, Aux2, or combinations of them
⇅	<b>SPEED2 U/C TRIP</b> <b>LEVEL: 0.70 X FLA</b>	Range: 0.10 to 0.99 x FLA in steps of 1
⇅	<b>SPEED2 U/C TRIP</b> <b>DELAY: 1 s</b>	Range: 1 to 255 seconds in steps of 1

The **SPEED2 UNDERCURRENT** protection is a separate protection for Speed 2, and has the same menu structure as the undercurrent protection for Speed 1 under **S4 CURRENT ELEMENTS/ UNDERCURRENT**. This protection is enabled when the setting under **S2 SYSTEM SETUP /CT/VT SETUP/ENABLE 2-SPEED MOTOR PROTECTION** is programmed as "Yes," and the physical **DIGITAL INPUTS/SPEED SWITCH =1**(closed).

When in Speed 2, the 369 will detect undercurrent conditions and initiate an alarm if any phase current drops below the **SPEED2 U/C ALARM LEVEL** setting for the time delay selected under **SPEED2 U/C ALARM DELAY**.

A trip will be initiated if the level of any phase current drops below the **SPEED2 U/C TRIP LEVEL** for the time delay selected under **SPEED2 U/C TRIP DELAY** time delay.

Additionally, **SPEED2 UNDERCURRENT** protection can be blocked during start in Speed 2, when selecting a time delay under **BLOCK SPEED2 U/C FROM START**. The timer starts timing out when the motor status as detected by the 369 changes from "Stopped" to "Starting."

Note that a motor status of "Stopped" will also be detected by the 369 during the switching from Speed 1 to Speed 2 if the status of the breaker is detected as "open" and the motor current drops below 5% of **SPEED2 CT** primary setting.

When switching from Speed 2 to Speed 1 (Speed Switch status detected as "open"), the **SPEED2 UNDERCURRENT** protection becomes inactive and the Speed 1 undercurrent protection found under **S4 CURRENT ELEMENTS / UNDERCURRENT** is then used by the 369.

#### 5.13.4 Speed 2 Acceleration

PATH: S12 TWO-SPEED MOTOR ↓**SPEED2 ACCELERATION**

<b>SPEED2 ACCELERATION</b>	ENTER	<b>SPEED2 ACCEL. TIMER</b> <b>FROM START: 10 S</b>	Range: 2.0 to 250.0 seconds in steps of 0.1 s
⇅		<b>ACCEL. TIMER FROM</b> <b>SPEED1 - 2: 10 s</b>	Range: 2.0 to 250.0 seconds in steps of 0.1 s
⇅		<b>SPEED SW SPEED2 TIME</b> <b>DELAY: 2.0 s</b>	Range: 0.5 to 100.0 seconds in steps of 0.5 s

The timer **SPEED2 ACCEL. TIMER FROM START** will start timing out, when the previous status of the motor was detected "STOPPED," the status of the Speed Switch contact is detected close (Speed 2), or the starting current is above 5%CT setting for Speed 2.

The timer **ACCEL. TIMER FROM SPEED1-2** will start timing out, when the previous status of the motor was detected “RUNNING”, or “OVERLOAD”, and the Speed Switch contact is detected closed (Speed 2),

The 369 relay will ignore any Mechanical Jam during the transition from Speed 1 to Speed 2, until the motor current drops below Speed 2 Overload PKP setting, or during the time of Speed1-2 acceleration timer. At that point the Mechanical Jam feature will be enabled with Speed 2 FLA.

When using the Two Speed Motor feature in a Forward/Reverse motor rotation application, switching between speeds will result in a state with no current (motor slows down to a stop) followed by a start in the opposite direction. In this application, the **ACCEL. TIMER FROM SPEED1-2** could be programmed with the same value as **SPEED2 ACCEL. TIMER FROM START**.

The **SPEED SW SPEED2 TIME DELAY** setting is available only if the “SPEED SWITCH” function is assigned to one of the DIGITAL INPUTS under setpoints **S9 DIGITAL INPUTS**.

**SPEED2 ACCEL. TIMER FROM START** and **ACCEL. TIMER FROM SPEED1-2** become functional only if the acceleration time at Speed 1 (see *S5 section 5.6.2: Acceleration Trip*) is enabled.











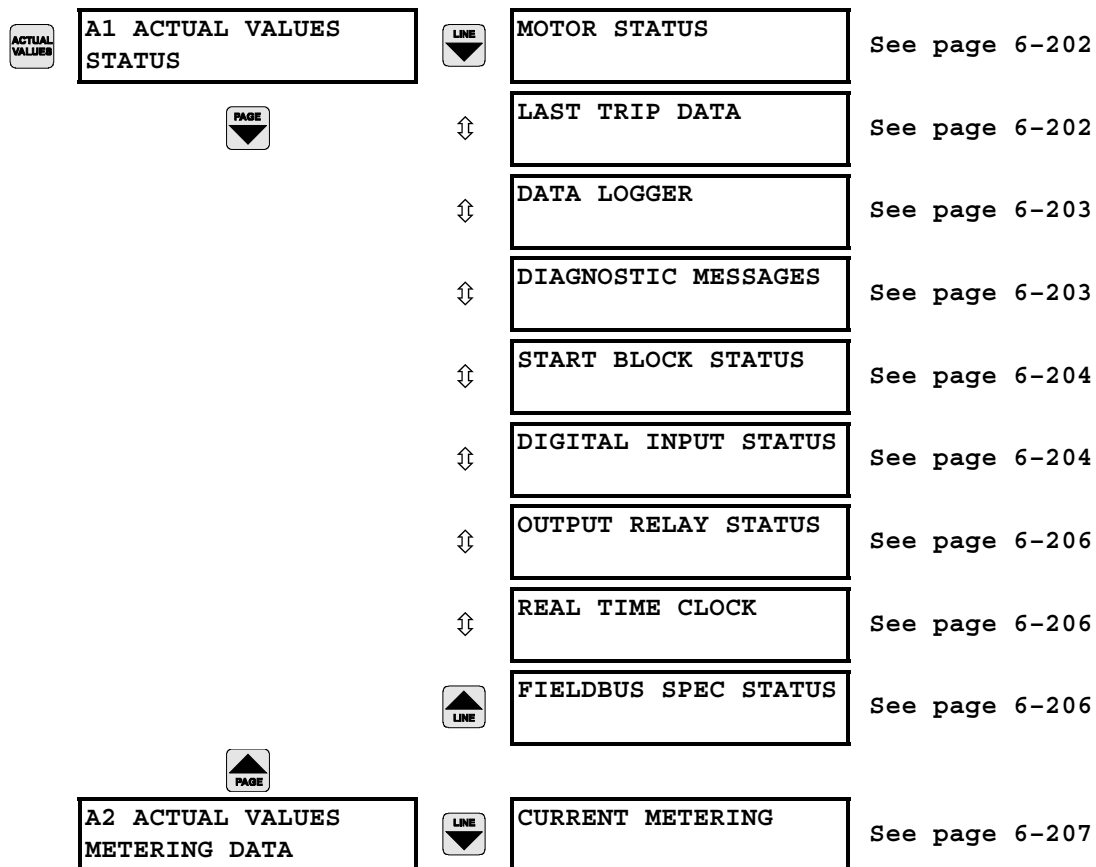







# 369 Motor Management Relay

## Chapter 6: Actual Values

### 6.1 Overview

#### 6.1.1 Actual Values Main Menu



	⇕	VOLTAGE METERING <sup>1</sup>	See page 6-207
	⇕	POWER METERING <sup>1</sup>	See page 6-208
	⇕	BACKSPIN METERING	See page 6-208
	⇕	LOCAL RTD <sup>2</sup>	See page 6-209
	⇕	REMOTE RTD <sup>3</sup>	See page 6-209
	⇕	OVERALL STATOR RTD <sup>4</sup>	See page 6-210
	⇕	DEMAND METERING	See page 6-210
		PHASORS	See page 6-211
		A3 ACTUAL VALUES LEARNED DATA	
		MOTOR DATA	See page 6-213
	⇕	LOCAL RTD MAXIMUMS	See page 6-214
		REMOTE RTD MAXIMUMS	See page 6-215
		A4 ACTUAL VALUES STATISTICAL DATA	
		TRIP COUNTERS	See page 6-216
		MOTOR STATISTICS	See page 6-217
		A5 ACTUAL VALUES EVENT RECORD	
		EVENT: 512	See page 6-219
	⇕	EVENT: 511	
	⇕	⇕	
	⇕	EVENT: 2	
		EVENT: 1	
		A6 ACTUAL VALUES RELAY INFORMATION	
		MODEL INFORMATION	See page 6-220



**FIRMWARE VERSION**

See page 6-220

1. Only shown if option M or B is installed
2. Only shown if option R is installed
3. Only shown if Channel 3 Application is programmed as RRTD
4. Only shown if option R is installed or Channel 3 Application is programmed as RRTD

## 6.2 A1 Status

### 6.2.1 Motor Status

PATH: A1 STATUS ↓ MOTOR STATUS

<b>MOTOR STATUS</b>	ENTER	<b>MOTOR STATUS:</b> Stopped	Range: Stopped, Starting, Running, Overload, Tripped
	LINE ▼	<b>MOTOR THERMAL CAPACITY USED:</b> 0%	Range: 0 to 100% in steps of 1
	⇕	<b>ESTIMATED TRIP TIME ON OVERLOAD:</b> Never	Range: Never, 0 to 65500 s in steps of 1
	▲ LINE	<b>MOTOR SPEED:</b> Low Speed	Range: Low Speed, High Speed Only shown if "Enable 2-Speed Motor Protection" is enabled.

These messages describe the status of the motor at the current point in time. The Motor Status message indicates the current state of the motor.

MOTOR STATE	DEFINITION
Stopped	phase current = 0 A and starter status input = breaker/contactors open
Starting	motor previously stopped and phase current has gone from 0 to > FLA
Running	FLA > phase current > 0 <b>or</b> starter status input = breaker/contactors closed and motor was previously running
Overload	motor previously running and phase current now > FLA
Tripped	a trip has been issued and not cleared

The Motor Thermal Capacity Used message indicates the current level which is used by the overload and cooling algorithms. The Estimated Trip Time On Overload is only active for the Overload motor status.



In Forward/Reverse motor applications, MOTOR SPEED is indicated as "Low Speed" for Forward rotation, and "High Speed" for Reverse rotation of motor.

### 6.2.2 Last Trip Data

PATH: A1 STATUS ↓↓ LAST TRIP DATA

<b>LAST TRIP DATA</b>	ENTER	<b>CAUSE OF LAST TRIP:</b> No Trip to date	Range: No Trip to Date, cause of trip
	LINE ▼	<b>LAST TRIP TIME:</b> 00:00:00	Range: hour: min: seconds
	⇕	<b>LAST TRIP DATE:</b> Feb 28 2007	Range: month day year

⇅	<b>SPEED OF LAST TRIP:</b> Low Speed	Range: Not Programmed, Low Speed, High Speed
⇅	A: 0      B: 0 C: 0      A Pretrip	Range: 0 to 100000 A in steps of 1
⇅	<b>MOTOR LOAD</b> Pretrip 0.00 x FLA	Range: 0.00 to 20.00 in steps of 0.01
⇅	<b>CURRENT UNBALANCE</b> Pretrip: 0%	Range: 0 to 100% in steps of 1
⇅	<b>GROUND CURRENT</b> Pretrip: 0.0 Amps	Range: 0.0 to 5000.0 Amps in steps of 0.1
⇅	<b>HOTTEST STATOR RTD:</b> Local RTD: 12 76°C	Range: Local, RRTD1, RRTD2, RRTD3, RRTD4 No RTD = open, Shorted = shorted RTD -40 to 200°C or -40 to 392°F
⇅	Vab: 0 Vbc: 0 Vca: 0 V Pretrip	Range: 0 to 20000 in steps of 1 Only shown if VT CONNECTION is programmed
⇅	Van: 0 Vbn: 0 Vcn: 0 V Pretrip	Range: 0 to 20000 in steps of 1 Only shown if VT CONNECTION is "Wye"
⇅	<b>SYSTEM FREQUENCY</b> Pretrip: 0.00 Hz	Range: 0.00, 15.00 to 120.00 in steps of 0.01 Only shown if VT CONNECTION is programmed
⇅	0 kW 0 kVA 0 kvar Pretrip	Range: -50000 to +50000 in steps of 1 Only shown if VT CONNECTION is programmed
	<b>POWER FACTOR</b> Pretrip: 1.00	Range: 0.00 lag to 1 to 0.00 lead Only shown if VT CONNECTION is programmed

Immediately prior to a trip, the 369 takes a snapshot of the metered parameters along with the cause of trip and the date and time and stores this as pre-trip values. This allows for ease of troubleshooting when a trip occurs. Instantaneous trips on starting (< 50 ms) may not allow all values to be captured. These values are overwritten when the next trip occurs. The event record shows details of the last 40 events including trips.

### 6.2.3 Data Logger

PATH: ACTUAL VALUE ↓ A1 ACTUAL VALUES STATUS ↓↓ DATA LOGGER

<b>DATA LOGGER</b>		Log Status: Running Memory Used: 100%	Line 1 Range: Stopped, Running Line 2 Range: 0 to 100%
--------------------	---	--	---

### 6.2.4 Diagnostic Messages

PATH: A1 STATUS ↓↓↓ DIAGNOSTIC MESSAGES

<b>DIAGNOSTIC MESSAGES</b>		No Trips or Alarms are Active	Range: No Trips or Alarms are Active, active alarm name and level, active trip name
----------------------------	---	----------------------------------	--

Any active trips or alarms may be viewed here. If there is more than one active trip or alarm, using the Line Up and Down keys will cycle through all the active alarm messages. If the Line Up and Down keys are not pressed, the active messages will automatically cycle. The current level causing the alarm is displayed along with the alarm name.

### 6.2.5 Start Block Status

PATH: A1 STATUS ↓↓⇅⇅ START BLOCK STATUS





START BLOCK STATUS	ENTER	OVERLOAD LOCKOUT TIMER: None	Range: 1 to 9999 min. in steps of 1
	LINE ▼	START INHIBIT TIMER: None	Range: 1 to 500 min. in steps of 1
	⇅	STARTS/HOUR TIMERS: 0 0 0 0 0 min	Range: 1 to 60 min. in steps of 1
	⇅	TIME BETWEEN STARTS TIMER: None	Range: 1 to 500 min. in steps of 1
	LINE ▲	RESTART BLOCK TIMER: None	Range: 1 to 50000 s in steps of 1

- **OVERLOAD LOCKOUT TIMER:** Determined from the thermal model, this is the remaining amount of time left before the thermal capacity available will be sufficient to allow another start and the start inhibit will be removed.
- **START INHIBIT TIMER:** If enabled this timer will indicate the remaining time for the Thermal Capacity to reduce to a level to allow for a safe start according to the Start Inhibit setpoints.
- **STARTS/HOUR TIMER:** If enabled this display will indicate the number of starts within the last hour by showing the time remaining in each. The oldest start will be on the left. Once the time of one start reaches 0, it is no longer considered a start within the hour and is removed from the display and any remaining starts are shifted over to the left.
- **TIME BETWEEN STARTS TIMER:** If enabled this timer will indicate the remaining time from the last start before the start inhibit will be removed and another start may be attempted. This time is measure from the beginning of the last motor start.
- **RESTART BLOCK TIMER:** If enabled this display will reflect the amount of time since the last motor stop before the start block will be removed and another start may be attempted.

### 6.2.6 Digital Input Status

PATH: A1 STATUS ↓↓⇅⇅⇅ DIGITAL INPUT STATUS

DIGITAL INPUT STATUS	ENTER	EMERGENCY RESTART: Open	Range: Open, Closed Note: Programmed input name displayed
	LINE ▼	DIFFERENTIAL RELAY: Open	Range: Open, Closed Note: Programmed input name displayed

	<b>SPEED SWITCH:</b> Open	Range: Open, Closed Note: Programmed input name displayed
	<b>RESET:</b> Open	Range: Open, Closed Note: Programmed input name displayed
	<b>ACCESS:</b> Open	Range: Open, Closed Note: Programmed input name displayed
	<b>SPARE:</b> Open	Range: Open, Closed Note: Programmed input name displayed

The present state of the digital inputs will be displayed here.

### 6.2.7 Output Relay Status

PATH: A1 STATUS ↓↓↓↓↓ OUTPUT RELAY STATUS

OUTPUT RELAY STATUS	ENTER	TRIP: De-energized	Range: Energized, De-energized
	LINE ↓	ALARM: De-energized	Range: Energized, De-energized
	↕	AUX 1: De-energized	Range: Energized, De-energized
	LINE ▲	AUX 2: De-energized	Range: Energized, De-energized

The present state of the output relays will be displayed here. Energized indicates that the NO contacts are now closed and the NC contacts are now open. De-energized indicates that the NO contacts are now open and the NC contacts are now closed.

### 6.2.8 Real Time Clock

PATH: A1 STATUS ↓↓↓↓↓ REAL TIME CLOCK

REAL TIME CLOCK	ENTER	DATE: 02/28/2007 TIME: 00:00:00	Range: month/day/year, hour: minute: second
-----------------	-------	------------------------------------	---

The date and time from the 369 real time clock may be viewed here.

### 6.2.9 FieldBus Specification Status

PATH: A1 STATUS ↓↓↓↓↓ FIELDBUS SPEC STATUS

FIELDBUS SPEC STATUS	ENTER	EXPLICIT STATUS: Nonexistent	Range: Nonexistent, Configuring, Established, Timed Out, Deleted
	LINE ↓	IO POLLED STATUS: Nonexistent	Range: Nonexistent, Configuring, Established, Timed Out, Deleted
	LINE ▲	NETWORK STATUS: Power Off/Not Online	Range: Power Off/Not Online, Online/Connected, Link Failure



When the device is on the non-connected bus, the **NETWORK STATUS** message will continually cycle between “Power Off/Not Online” and “Online/Connected”.

## 6.3 A2 Metering Data

### 6.3.1 Current Metering

PATH: A2 METERING DATA ↓ CURRENT METERING

CURRENT METERING	ENTER	A: 0      B: 0 C: 0      Amps	Range: 0 to 65535 A in steps of 1
	LINE	AVERAGE PHASE CURRENT: 0 Amps	Range: 0 to 65535 A in steps of 1
	↕	MOTOR LOAD: 0.00 X FLA	Range: 0.00 to 20.00 x FLA in steps of 0.01
	↕	CURRENT UNBALANCE: 0%	Range: 0 to 100% in steps of 1
	↕	U/B BIASED MOTOR LOAD: 0.00 x FLA	Range: 0.00 to 20.00 x FLA in steps of 0.01. Only visible if unbalance biasing is enabled in thermal
	LINE	GROUND CURRENT: 0.0 Amps	Range: 0 to 6553.5 A in steps of 0.1 (for 1A/5A CT) 0.00 to 25.00 A in steps of 0.01 (for 50:0.025 A CT)

All measured current values are displayed here. Note that the unbalance level is de-rated below FLA. See the unbalance setpoints in Section 5.4.2 *Thermal Model* on page 5–142 for more details.

### 6.3.2 Voltage Metering

PATH: A2 METERING DATA ↓↓ VOLTAGE METERING

VOLTAGE METERING	ENTER	Vab: 0      Vbc: 0 Vca: 0      V RMS $\phi$ - $\phi$	Range: 0 to 65535 V in steps of 1 Only shown if VT CONNECTION is programmed
	LINE	AVERAGE LINE VOLTAGE: 0 V	Range: 0 to 65535 V in steps of 1 Only shown if VT CONNECTION is programmed
	↕	Va: 0      Vb: 0 Vc: 0      V RMS $\phi$ -N	Range: 0 to 65535 V in steps of 1 Only shown if a Wye connection programmed
	↕	AVERAGE PHASE VOLTAGE: 0 V	Range: 0 to 65535 V in steps of 1 Only shown if a Wye connection programmed
	LINE	SYSTEM FREQUENCY: 0.00 Hz	Range: 0.00, 15.00 to 120.00 Hz in steps of 0.01

Measured voltage parameters will be displayed here. These displays are only visible if option M or B has been installed.

### 6.3.3 Power Metering

PATH: A2 METERING DATA ⇓⇓⇓ POWER METERING

POWER METERING	ENTER	POWER FACTOR: 1.00	Range: 0.00 to 1.00 lag or lead
	LINE	REAL POWER: 0 kW	Range: -32000 to 32000 kW in steps of 1
	⇕	REAL POWER: 0 hp	Range: 0 to 42912 hp in steps of 1
	⇕	REACTIVE POWER: 0 kvar	Range: -32000 to 32000 kvar in steps of 1
	⇕	APPARENT POWER: 0 kVA	Range: 0 to 65000 kVA in steps of 1
	⇕	POSITIVE WATTHOURS: 0 MWh	Range: 0 to 65535 MWh or 0 to 999 kWh in steps of 1
	⇕	POSITIVE VARHOURS: 0 Mvarh	Range: 0 to 65535 Mvarh or 0 to 999 kvarh in steps of 1
	LINE	NEGATIVE VARHOURS: 0 Mvarh	Range: 0 to 65535 Mvarh or 0 to 999 kvarh in steps of 1

These actual values are only shown if the **VT CONNECTION TYPE** setpoint has been programmed (i.e., is not set to “None”). The values for three phase power metering, consumption and generation are displayed here. The energy values displayed here will be in units of MWh/Mvarh or kWh/kvarh, depending on the **S1 369 SETUP ⇒ DISPLAY PREFERENCES ⇒ ENERGY UNIT DISPLAY** setpoint. The energy registers will roll over to zero and continue accumulating once their respective maximums have been reached. The MWh/Mvarh registers will continue accumulating after their corresponding kWh/kvarh registers have rolled over. The actual energy is a summation of both the kilo and Mega values.

These displays are only visible if option M or B has been installed.

### 6.3.4 Backspin Metering

PATH: A2 METERING DATA ⇓⇓⇓⇓ BACKSPIN METERING

BACKSPIN METERING	ENTER	BACKSPIN FREQUENCY: Low Signal	Range: Low Signal, 1 to 120 Hz in steps of 0.01 Only shown if option B installed and enabled.
	LINE	BACKSPIN DETECTION STATE:	Range: Motor Running, No Backspin, Slowdown, Acceleration, Backspinning, Prediction, Soon to Restart. Seen only if Backspin Start Inhibit is enabled
	LINE	BACKSPIN PREDICTION TIMER: 30 s	Range: 0 to 50000 s in steps of 1. Shown only if Backspin Start Inhibit is enabled and predication timer is enabled.

Backspin metering parameters are displayed here. These values are shown if option B has been installed and the **ENABLE BACKSPIN START INHIBIT** setting is “Yes”.



### 6.3.5 Local RTD

PATH: A2 METERING DATA ↓↓↓↓ LOCAL RTD

LOCAL RTD	ENTER	HOTTEST STATOR RTD NUMBER: 1	Range: None, 1 to 12 in steps of 1
	LINE	HOTTEST STATOR RTD TEMPERATURE: 40 °C	Range: -40 to 200°C or -40 to 392°F No RTD = open, Shorted = shorted RTD
	↕	RTD #1 TEMPERATURE: 40 °C	Range: -40 to 200°C or -40 to 392°F No RTD = open, Shorted = shorted RTD
	↕	RTD #2 TEMPERATURE: 40 °C	Range: -40 to 200°C or -40 to 392°F No RTD = open, Shorted = shorted RTD
	↕	RTD #12 TEMPERATURE: 40 °C	Range: -40 to 200°C or -40 to 392°F No RTD = open, Shorted = shorted RTD
	LINE	RTD #12 TEMPERATURE: 40 °C	Range: -40 to 200°C or -40 to 392°F No RTD = open, Shorted = shorted RTD

The temperature level of all 12 internal RTDs are displayed here if the 369 has option R enabled. The programmed name of each RTD (if changed from the default) appears as the first line of each message. These displays are only visible if option R has been installed.

### 6.3.6 Remote RTD

PATH: A2 METERING DATA ↓↓↓↓ REMOTE RTD ↓ REMOTE RTD MODULE 1(4)

REMOTE RTD MODULE 1	ENTER	MOD 1 HOTTEST STATOR NUMBER: 0	Range: None, 1 to 12 in steps of 1
	LINE	MOD 1 HOTTEST STATOR TEMPERATURE: 40 °C	Range: -40 to 200°C or -40 to 392°F No RTD = open, Shorted = shorted RTD
	↕	RRTD 1 RTD #1 TEMPERATURE: 40 °C	Range: -40 to 200°C or -40 to 392°F No RTD = open, Shorted = shorted RTD
	↕	RRTD 1 RTD #2 TEMPERATURE: 40 °C	Range: -40 to 200°C or -40 to 392°F No RTD = open, Shorted = shorted RTD
	↕	RRTD 1 RTD #12 TEMPERATURE: 40 °C	Range: -40 to 200°C or -40 to 392°F No RTD = open, Shorted = shorted RTD
	LINE	RRTD 1 RTD #12 TEMPERATURE: 40 °C	Range: -40 to 200°C or -40 to 392°F No RTD = open, Shorted = shorted RTD

The temperature level of all 12 remote RTDs will be displayed here if programmed and connected to a RRTD module. The name of each RRTD (if changed from the default) will appear as the first line of each message. These displays are only visible if option R has been installed.

If communications with the RRTD module is lost, the **RRTD MODULE COMMUNICATIONS LOST** message will be displayed.

### 6.3.7 Overall Stator RTD

PATH: A2 METERING DATA ↓↓↓↓↓ OVERALL STATOR RTD

OVERALL STATOR RTD	ENTER	HOTTEST OVERALL STATOR TEMP: 70 °C	Range: -40 to 200°C or -40 to 392°F No RTD = open, Shorted = shorted RTD
	LINE	HOTTEST STATOR RTD: Local 369 RTD#: 4	Range: No RTD, Local 369, RRTD#1 to RRTD#4 (for RTD Name), 1 to 12 in steps of 1 (for RTD #)

### 6.3.8 Demand Metering

PATH: A2 METERING DATA ↓↓↓↓↓ DEMAND METERING

DEMAND METERING	ENTER	CURRENT DEMAND: 0 Amps	Range: 0 to 65535 A in steps of 1
	LINE	REAL POWER DEMAND: 0 kW	Range: 0 to 32000 kW in steps of 1 Only shown if VT CONNECTION programmed
	↕	REACTIVE POWER DEMAND: 0 kvar	Range: 0 to 32000 kvar in steps of 1 Only shown if VT CONNECTION programmed
	↕	APPARENT POWER DEMAND: 0 kVA	Range: 0 to 65000 kVA in steps of 1 Only shown if VT CONNECTION programmed
	↕	PEAK CURRENT DEMAND: 0 Amps	Range: 0 to 65535 A in steps of 1
	↕	PEAK REAL POWER DEMAND: 0 kW	Range: 0 to 32000 kW in steps of 1 Only shown if VT CONNECTION programmed
	↕	PEAK REACTIVE POWER DEMAND: 0 kvar	Range: 0 to 32000 kvar in steps of 1 Only shown if VT CONNECTION programmed
	LINE	PEAK APPARENT POWER DEMAND: 0 kVA	Range: 0 to 65000 kVA in steps of 1 Only shown if VT CONNECTION programmed

The values for current and power demand are displayed here. Peak demand information can be cleared using the **CLEAR PEAK DEMAND** command located in **S1 369 SETUP ↓ CLEAR/PRESET DATA**. Demand is only shown for positive real (kW) and reactive (kvar) powers. Only the current demand will be visible if options M or B are not installed.

### 6.3.9 Phasors

PATH: A2 METERING DATA ▾ ▾ ▾ ▾ ▾ ▾ ▾ ▾ PHASORS

<b>PHASORS</b>	ENTER	<b>Ia PHASOR:</b> 0 Degrees Lag	Range: 0 to 359 degrees in steps of 1
	LINE ▼	<b>Ib PHASOR:</b> 0 Degrees Lag	Range: 0 to 359 degrees in steps of 1
	↕	<b>Ic PHASOR:</b> 0 Degrees Lag	Range: 0 to 359 degrees in steps of 1
	↕	<b>Vax PHASOR:</b> 0 Degrees Lag	Range: 0 to 359 degrees in steps of 1 Only shown if VT CONNECTION is programmed Van if WYE connection, Vab if Open Delta Connection
	↕	<b>Vbx PHASOR:</b> 0 Degrees Lag	Range: 0 to 359 degrees in steps of 1 Only shown if VT CONNECTION is programmed Vbn if WYE connection, Vbc if Open Delta Connection
	LINE ▲	<b>Vcx PHASOR:</b> 0 Degrees Lag	Range: 0 to 359 degrees in steps of 1 Only shown if VT CONNECTION is programmed Vcn if WYE connection, Vca if Open Delta Connection

All angles shown are with respect to the reference phasor. The reference phasor is based on the VT connection type. In the event that option M has not been installed,  $V_{an}$  for Wye is 0 V, or  $V_{ab}$  for Delta is 0 V,  $I_a$  will be used as the reference phasor

Reference Phasor	VT Connection Type
$I_a$	None
$V_{an}$	Wye
$V_{ab}$	Delta

Note that the phasor display is not intended to be used as a protective metering element. Its prime purpose is to diagnose errors in wiring connections.

To aid in wiring, the following tables can be used to determine if VTs and CTs are on the correct phase and their polarity is correct. Problems arising from incorrect wiring are extremely high unbalance levels (CTs), erroneous power readings (CTs and VTs), or phase reversal trips (VTs). To correct wiring, simply start the motor and record the phasors. Using the following tables along with the recorded phasors, system rotation, VT connection type, and motor power factor, the correct phasors can be determined. Note that  $V_a$  ( $V_{ab}$  if delta) is always assumed to be  $0^\circ$  and is the reference for all angle measurements.

Common problems include:

- Phase currents  $180^\circ$  from proper location (CT polarity reversed)
- Phase currents or voltages  $120^\circ$  or  $240^\circ$  out (CT/VT on wrong phase.)

**Table 6-1: Three Phase Wye VT Connection**

<b>ABC ROTATION</b>	<b>72.5° = 0.3 PF LAG</b>	<b>45° = 0.7 PF LAG</b>	<b>0° = 1.00 PF</b>	<b>-45° = 0.7 PF LEAD</b>	<b>-72.5° = 0.2 PF LEAD</b>
Van	0	0	0	0	0
Vbn	120	120	120	120	120
Vcn	240	240	240	240	240
Ia	72.5	45	0	315	287.5
Ib	192.5	165	120	75	47.5
Ic	312.5	285	240	195	167.5
KW	+	+	+	+	+
kVar	+	+	0	-	-
kVA	+	+	+ (= kW)	+	+

<b>ACB ROTATION</b>	<b>72.5° = 0.3 PF LAG</b>	<b>45° = 0.7 PF LAG</b>	<b>0° = 1.00 PF</b>	<b>-45° = 0.7 PF LEAD</b>	<b>-72.5° = 0.2 PF LEAD</b>
Van	0	0	0	0	0
Vbn	240	240	240	240	240
Vcn	120	120	120	120	120
Ia	72.5	45	0	315	287.5
Ib	312.5	285	240	195	167.5
Ic	192.5	165	120	75	47.5
kW	+	+	+	+	+
kvar	+	+	0	-	-
kVA	+	+	+ (= kW)	+	+

**Table 6-2: Three Phase Open Delta VT Connection**

<b>ABC ROTATION</b>	<b>72.5° = 0.3 PF LAG</b>	<b>45° = 0.7 PF LAG</b>	<b>0° = 1.00 PF</b>	<b>-45° = 0.7 PF LEAD</b>	<b>-72.5° = 0.3 PF LEAD</b>
Vab	0	0	0	0	0
Vbc	120	120	120	120	120
Vca	240	240	240	240	240
Ia	102.5	75	30	345	317.5
Ib	222.5	195	150	105	77.5
Ic	342.5	315	270	225	197.5
kW	+	+	+	+	+
kvar	+	+	0	-	-
kVA	+	+	+ (= kW)	+	+

<b>ACB ROTATION</b>	<b>72.5° = 0.3 PF LAG</b>	<b>45° = 0.7 PF LAG</b>	<b>0° = 1.00 PF</b>	<b>-45° = 0.7 PF LEAD</b>	<b>-72.5° = 0.3 PF LEAD</b>
Vab	0	0	0	0	0
Vbc	240	240	240	240	240
Vca	120	120	120	120	120
Ia	42.5	15	330	285	257.5
Ib	282.5	255	210	165	137.5
Ic	162.5	135	90	45	17.5
kW	+	+	+	+	+
kvar	+	+	0	-	-
kVA	+	+	+ (= kW)	+	+

## 6.4 A3 Learned Data

### 6.4.1 Description

This page contains the data the 369 learns to adapt itself to the motor protected.

### 6.4.2 Motor Data

PATH: A3 LEARNED DATA ↓ MOTOR DATA

MOTOR DATA	ENTER	LEARNED ACCELERATION TIME: 0.0 s	Range: 1.0 to 250.0 s in steps of 0.1
	LINE ▼	LEARNED STARTING CURRENT: 0 A	Range: 0 to 100000 A in steps of 1
	⇕	LEARNED STARTING CAPACITY: 85%	Range: 0 to 100% in steps of 1
	⇕	LEARNED RUNNING COOL TIME CONST.: 0 min	Range: 0 to 500 min in steps of 1
	⇕	LEARNED STOPPED COOL TIME CONST.: 0 min	Range: 0 to 500 min in steps of 1
	⇕	LAST STARTING CURRENT: 0 A	Range: 0 to 100000 A in steps of 1
	⇕	LAST STARTING CAPACITY: 85%	Range: 0 to 100% in steps of 1%
	⇕	LAST ACCELERATION TIME: 0.0 s	Range: 1.0 to 250.0 s in steps of 0.1
	⇕	AVERAGE MOTOR LOAD LEARNED: 0.00 X FLA	Range: 0.00 to 20.00 x FLA in steps of 0.01
	⇕	LEARNED UNBALANCE k FACTOR: 0	Range: 0 to 29 in steps of 1
	⇕	AVG. RUN TIME AFTER START: 14 hours, 22 min	Range: 65535 days, 1440 minutes
	⇕	DATE OF RECORD Feb 14 2007	Range: month/day/year
	LINE ▲	NUMBER OF RECORDS 250	Range: 0 to 65535

The learned values for acceleration time and starting current are the average of the individual values acquired for the last five successful starts. The value for starting current is used when learned k factor is enabled.

The learned value for starting capacity is the amount of thermal capacity required for a start determined by the 369 from the last five successful motor starts. The last five learned start capacities are averaged and a 25% safety margin factored in. This guarantees enough thermal capacity available to start the motor. The Start Inhibit feature, when enabled, uses this value in determining lockout time.

The learned cool time constants and unbalance *k* factor are displayed here. The learned value is the average of the last five measured constants. These learned cool time constants are used only when the **ENABLE LEARNED COOL TIMES** thermal model setpoint is "Yes". The learned unbalance *k* factor is the average of the last five calculated *k* factors. The learned *k* factor is only used when unbalance biasing of thermal capacity is set on and to learned.

Note that learned values are calculated even when features requiring them are turned off. The learned features should not be used until at least five successful motor starts and stops have occurred.

Starting capacity, starting current, and acceleration time values are displayed for the last start. The average motor load while running is also displayed here. The motor load is averaged over a 15 minute sliding window.

Clearing motor data (see Section 5.2.10: Clear/Preset Data on page –120) resets these values to their default settings.

### 6.4.3 Local RTD Maximums

PATH: A3 LEARNED DATA ⇓⇓ LOCAL RTD MAXIMUMS

LOCAL RTD MAXIMUMS	ENTER	RTD #1 MAXIMUM TEMPERATURE: 40 °C	Range: -40 to 200°C or -40 to 392°F No RTD = open, Shorted = shorted RTD
	LINE	RTD #2 MAXIMUM TEMPERATURE: 40 °C	Range: -40 to 200°C or -40 to 392°F No RTD = open, Shorted = shorted RTD
	⇕	RTD #3 MAXIMUM TEMPERATURE: 40 °C	Range: -40 to 200°C or -40 to 392°F No RTD = open, Shorted = shorted RTD
	⇕	RTD #12 MAXIMUM TEMPERATURE: 40 °C	Range: -40 to 200°C or -40 to 392°F No RTD = open, Shorted = shorted RTD

The maximum temperature level of all 12 internal RTDs will be displayed here if the 369 has option R enabled. The programmed name of each RTD (if changed from the default) will appear as the first line of each message.

These displays are only visible if option R has been installed and RTDs have been programmed.

### 6.4.4 Remote RTD Maximums

PATH: A3 LEARNED DATA ↓↓↓ REMOTE RTD MAXIMUMS ↓ RRTD #1(4)



RRTD #1	ENTER	<b>RTD #1 MAXIMUM</b> <b>TEMPERATURE: 40 °C</b>	<i>Range: -40 to 200°C or -40 to 392°F</i> <i>No RTD = open, Shorted = shorted RTD</i>
	LINE ▼	<b>RTD #2 MAXIMUM</b> <b>TEMPERATURE: 40 °C</b>	<i>Range: -40 to 200°C or -40 to 392°F</i> <i>No RTD = open, Shorted = shorted RTD</i>
	↕	<b>RTD #3 MAXIMUM</b> <b>TEMPERATURE: 40 °C</b>	<i>Range: -40 to 200°C or -40 to 392°F</i> <i>No RTD = open, Shorted = shorted RTD</i>
	↕	<b>RTD #12 MAXIMUM</b> <b>TEMPERATURE: 40 °C</b>	<i>Range: -40 to 200°C or -40 to 392°F</i> <i>No RTD = open, Shorted = shorted RTD</i>

The maximum temperature level of the 12 remote RTDs for each RRTD will be displayed here if the 369 has been programmed and connected to a RRTD module. The programmed name of each RTD (if changed from the default) will appear as the first line of each message. If an RRTD module is connected and no RRTDs are programmed, the display reads **NO RRTDS PROGRAMMED** when an attempt is made to enter this actual values page.

## 6.5 A4 Statistical Data

### 6.5.1 Trip Counters

PATH: A4 STATISTICAL DATA ▾ TRIP COUNTERS

<div style="border: 1px solid black; padding: 2px; margin-bottom: 5px;">TRIP COUNTERS</div> <div style="margin-bottom: 5px;">  </div> <div style="margin-bottom: 5px;">  </div> <div style="margin-bottom: 5px;">⇅</div> <div style="margin-bottom: 5px;">⇅</div> <div style="margin-bottom: 5px;">⇅</div> <div style="margin-bottom: 5px;">⇅</div> <div style="margin-bottom: 5px;">⇅</div> <div style="margin-bottom: 5px;">⇅</div> <div style="margin-bottom: 5px;">⇅</div> <div style="margin-bottom: 5px;">⇅</div> <div style="margin-bottom: 5px;">⇅</div> <div style="margin-bottom: 5px;">⇅</div> <div style="margin-bottom: 5px;">⇅</div> <div style="margin-bottom: 5px;">⇅</div> <div style="margin-bottom: 5px;">⇅</div>	TOTAL NUMBER OF TRIPS: 0	<i>Range: 0 to 50000 in steps of 1</i>
	INCOMPLETE SEQUENCE TRIPS: 0	<i>Range: 0 to 50000 in steps of 1</i>
	SWITCH TRIPS: 0	<i>Range: 0 to 50000 in steps of 1</i>
	OVERLOAD TRIPS: 0	<i>Range: 0 to 50000 in steps of 1</i>
	SHORT CIRCUIT TRIPS: 0	<i>Range: 0 to 50000 in steps of 1</i>
	MECHANICAL JAM TRIPS: 0	<i>Range: 0 to 50000 in steps of 1</i>
	UNDERCURRENT TRIPS: 0	<i>Range: 0 to 50000 in steps of 1</i>
	CURRENT UNBALANCE TRIPS: 0	<i>Range: 0 to 50000 in steps of 1</i>
	SINGLE PHASE TRIPS: 0	<i>Range: 0 to 50000 in steps of 1</i>
	GROUND FAULT TRIPS: 0	<i>Range: 0 to 50000 in steps of 1</i>
	ACCELERATION TRIPS: 0	<i>Range: 0 to 50000 in steps of 1</i>
	STATOR RTD TRIPS <sup>1</sup> : 0	<i>Range: 0 to 50000 in steps of 1</i>
	BEARING RTD TRIPS <sup>1</sup> : 0	<i>Range: 0 to 50000 in steps of 1</i>
	OTHER RTD TRIPS <sup>1</sup> : 0	<i>Range: 0 to 50000 in steps of 1</i>
	AMBIENT RTD TRIPS <sup>1</sup> : 0	<i>Range: 0 to 50000 in steps of 1</i>
UNDERVOLTAGE TRIPS <sup>2</sup> : 0	<i>Range: 0 to 50000 in steps of 1</i>	
OVERVOLTAGE TRIPS <sup>2</sup> : 0	<i>Range: 0 to 50000 in steps of 1</i>	
PHASE REVERSAL TRIPS: 0	<i>Range: 0 to 50000 in steps of 1</i>	





⇅	UNDERFREQUENCY TRIPS: 0	Range: 0 to 50000 in steps of 1
⇅	OVERFREQUENCY TRIPS: 0	Range: 0 to 50000 in steps of 1
⇅	LEAD POWER FACTOR TRIPS <sup>3</sup> : 0	Range: 0 to 50000 in steps of 1
⇅	LAG POWER FACTOR TRIPS <sup>3</sup> : 0	Range: 0 to 50000 in steps of 1
⇅	POSITIVE REACTIVE TRIPS <sup>3</sup> : 0	Range: 0 to 50000 in steps of 1
⇅	NEGATIVE REACTIVE TRIPS <sup>3</sup> : 0	Range: 0 to 50000 in steps of 1
⇅	UNDERPOWER TRIPS <sup>3</sup> : 0	Range: 0 to 50000 in steps of 1
⇅	REVERSE POWER TRIPS <sup>3</sup> : 0	Range: 0 to 50000 in steps of 1
	TRIP COUNTERS LAST CLEARED: 02/28/2007	Range: 0 to 50000 in steps of 1

- 1. Only shown if option R installed or Channel 3 Application is programmed as RRTD
- 2. Only shown if option M or B are installed
- 3. Only shown if option M or B are installed and VT CONNECTION is programmed

The number of trips by type is displayed here. When the total reaches 50000, the counter resets to 0 on the next trip and continues counting. This information can be cleared with the setpoints in the **CLEAR/PRESET DATA** section of setpoints page one. The date the counters are cleared will be recorded.

### 6.5.2 Motor Statistics

PATH: A4 STATISTICAL DATA ⇅⇅ MOTOR STATISTICS

<b>MOTOR STATISTICS</b>		NUMBER OF MOTOR STARTS: 0	Range: 0 to 50000 in steps of 1
		NUMBER OF EMERGENCY RESTARTS: 0	Range: 0 to 50000 in steps of 1
	⇅	MOTOR RUNNING HOURS: 0 hrs	Range: 0 to 100000 in steps of 1
	⇅	AUTORESTART START ATTEMPTS: 0	Range: 0 to 50000 in steps of 1
	⇅	TIME TO AUTORESTART: 0	Range: 0 to 50000 in steps of 1
		COUNTER: 0 Units	Range: 0 to 65535 Units in steps of 1 Shown if Counter set to a digital input













**NUMBER OF MOTOR STARTS**, and **NUMBER OF EMERGENCY RESTARTS** values display the number of motor starts and emergency restarts respectively. This information is useful for troubleshooting a motor failure or in understanding the history and use of a motor for maintenance purposes. When any of these counters reaches 50000, they are automatically reset to 0.

The **MOTOR RUNNING HOURS** indicates the elapsed time since the 369 determined the motor to be in a running state (current applied and/or starter status indicating contactor/breaker closed). The **NUMBER OF MOTOR STARTS**, **NUMBER OF EMERGENCY RESTARTS**, and **MOTOR RUNNING HOURS** counters can be cleared with the **S1 369 SETUP ↴ CLEAR/PRESET DATA ↴ CLEAR MOTOR DATA** setpoint.

## 6.6 A5 Event Record

### 6.6.1 Event Records

PATH: A5 EVENT RECORD ▾ EVENT 01

EVENT 01		<b>TIME OF EVENT 01</b> 00:00:00:00	Time: hours / minutes / seconds / hundreds of seconds
		<b>DATE OF EVENT 01</b> Feb. 28, 2007	Date: month / day / year
		<b>MOTOR SPEED DURING EVENT:</b> High Speed	Range: Not Programmed, Low Speed, High Speed
		A: 0      B: 0 C: 0      A    E: 01	Range: 0 to 65535 A in steps of 1
		<b>MOTOR LOAD</b> 0.00 X FLA    E: 01	Range: 0.00 to 20.00 x FLA in steps of 0.01
		<b>CURRENT UNBALANCE:</b> 0%            E: 01	Range: 0 to 100% in steps of 1
		<b>GROUND CURRENT:</b> 0.0 Amps    E: 01	Range: 0.0 to 5000.0 A steps of 0.1 (1A/5A CT) 0.00 to 25.00 A steps of 0.01 (50: 0.025 A CT)
		<b>HOTTEST STATOR RTD:</b> Local RTD: 12 76°C	Range: Local, RRTD1, RRTD2, RRTD3, RRTD4 No RTD = open, Shorted = shorted RTD -40 to 200°C or -40 to 392°F
		Vab: 0 Vbc: 0 Vca: 0 V    E: 01	Range: 0 to 20000 V in steps of 1 Only shown if VT CONNECTION is "Delta"
		Van: 0 Vbn: 0 Vcn: 0 V    E: 01	Range: 0 to 20000 V in steps of 1 Only shown if VT CONNECTION is "Wye"
		<b>SYSTEM FREQUENCY:</b> 0.00 Hz    E: 01	Range: 0.00, 15.00 to 120 Hz in steps of 1 Only shown if VT CONNECTION is programmed
		0 kW      0 kVA 0 kvar    E: 01	Range: -50000 to +50000 in steps of 1 Only shown if VT CONNECTION is programmed
		<b>POWER FACTOR:</b> 1.00       E: 01	Range: 0.00 lag to 1 to 0.00 lead Only shown if VT CONNECTION is programmed

A breakdown of the last 512 events is available here along with the cause of the event and the date and time. All trips automatically trigger an event. Alarms only trigger an event if turned on for that alarm. Loss or application of control power, service alarm and emergency restart opening and closing also triggers an event. After 512 events have been recorded, the oldest one is removed when a new one is added. The event record may be cleared in the setpoints page 1, clear/preset data, clear event record section.

### 6.6.2 Model Information

PATH: A6 RELAY INFORMATION ↓ MODEL INFORMATION

<b>MODEL INFORMATION</b>	ENTER	<b>SERIAL NUMBER:</b> MXXXXXXXXX	<i>Range: See Autolabel for details</i>
	LINE ▼	<b>INSTALLED OPTIONS:</b> 369-HI-R-M-0-P1-0-E	<i>Range: HI/LO, R/O, M/B/O, F/O, P/P1/E/D/O, H/O, E/O</i>
	↕	<b>MANUFACTURE DATE:</b> Feb. 28 2007	<i>Range: month/day/year</i>
	LINE ▲	<b>LAST CALIBRATION DATE:</b> Feb. 28 2007	<i>Range: month/day/year</i>

The relay model and manufacturing information may be viewed here. The last calibration date is the date the relay was last calibrated at GE Multilin.

### 6.6.3 Firmware Version

PATH: A6 RELAY INFORMATION ↓↓ FIRMWARE VERSION

<b>FIRMWARE VERSION</b>	ENTER	<b>FIRMWARE REVISION:</b> 320	
	LINE ▼	<b>BUILD DATE &amp; TIME:</b> Mar 18, 2008 15:39:40	
	↕	<b>BOOT REVISION:</b> 100	
	LINE ▲	<b>FIELDBUS CARD SW REVISION:</b> 112	<i>Note: Only shown with the Profibus (P or P1), Modbus/TCP (E), and DeviceNet (D) options.</i>

This information reflects the revisions of the software currently running in the 369 Relay. This information should be noted and recorded before calling for technical support or service.



# 369 Motor Management Relay

## Chapter 7: Applications

### 7.1 269-369 Comparison

#### 7.1.1 369 and 269plus Comparison

Table 7-1: Comparison Between 369 Relay and 269plus

369	269Plus
All options can be turned on or added in the field	Must be returned for option change or add other devices
Current and optional voltage inputs are included on all relays	Current inputs only. Must use additional meter device to obtain voltage and power measurements.
Optional 12 RTDs with an additional 12 RTDs available with the RRTD. All RTDs are individually configured (100P, 100N, 120N, 10C)	10 RTDs not programmable, must be specified at time of order.
Fully programmable digital inputs	No programmable digital inputs
4 programmable analog outputs assignable to 33 parameters	1 Analog output programmable for 5 parameters
1 RS232 (19.2K baud), 3 RS485 (1200 TO 19.2K baud programmable) communication ports. Also Optional profibus port and optional fiber optics port	1 RS485 Communication port (2400 baud maximum)
Flash memory firmware upgrade thru PC software and comm port	EPROM must be replaced to change firmware
EVENT RECORDER: time and date stamp last 512 events. Records all trips and selectable alarms	Displays cause of last trip and last event

**Table 7-1: Comparison Between 369 Relay and 269plus**

<b>369</b>	<b>269Plus</b>
OSCILLOGRAPHY: up to 64 cycles at 16 samples/cycle for last event(s)	N/A
Programmable text message(s)	N/A
Backspin frequency detection and backspin timer	Backspin timer
Starter failure indication	N/A
Measures up to 20 x CT at 16 samples/cycle	Measures up to 12 x CT at 12 samples/cycle
15 standard overload curves	8 standard overload curves
Remote display is standard	Remote display with mod

---

## 7.2 369 FAQs

### 7.2.1 Frequently Asked Questions (FAQs)

#### 1. What is the difference between Firmware and Software?

Firmware is the program running inside the relay, which is responsible for all relay protection and control elements. Software is the program running on the PC, which is used to communicate with the relay and provide relay control remotely in a user friendly format.

#### 2. How can I obtain copies of the latest manual and PC software?

**I need it now!:** via the GE Multilin website at <http://www.GEindustrial.com/multilin>

**I guess I can wait:** fax a request to the GE Multilin Literature department at (905) 201-2113

#### 3. Cannot communicate through the front port (RS232).

Check the following settings:

- Communication Port (COM1, COM2, COM3 etc.) on PC or PLC
- Parity settings must match between the relay and the master (PC or PLC)
- Baud rate setting on the master (PC or PLC) must match RS232 baud rate on the 369 relay.
- Cable has to be a straight through cable, do not use null modem cables where pin 2 and 3 are transposed
- Check the pin outs of RS232 cable (TX - pin 2, RX - pin 3, GND - pin 5)

#### 4. Cannot communicate with RS485.

Check the following settings:

- Communication Port (COM1, COM2, COM3 etc.) on PC or PLC
- Parity settings must match between the relay and the master (PC or PLC)
- Baud rate must match between the relay and the master
- Slave address polled must match between the relay and the master
- Is terminating filter circuit present?
- Are you communicating in half duplex? (369 communicates in half duplex mode only)
- Is wiring correct? (“+” wire should go to “+” terminal of the relay, and “-” goes to “-” terminal)
- Is the RS485 cable shield grounded? (shielding diminishes noise from external EM radiation)

Check the appropriate communication port LED on the relay. The LED should be solidly lit when communicating properly. The LED will blink on and off when the relay has communication difficulties and the LED will be off if no activity detected on communication lines.

#### 5. Can the 4 wire RS485 (full duplex) be used with 369?

No, the 369 communicates in 2-wire half duplex mode only. However, there are commercial RS485 converters that will convert a 4 wire to a 2 wire system.

**6. Cannot store setpoint into the relay.**

Check and ensure the ACCESS switch is shorted, and check for any PASSCODE restrictions.

**7. The 369 relay displays incorrect power reading, yet the power system is balanced. What could be the possible reasons?**

It is highly possible that the secondary wiring to the relay is not correct. Incorrect power can be read when any of the A, B, or C phases are swapped, a CT or VT is wired backwards, or the relay is programmed as ABC sequence when the power system is actually ACB and vice versa. The easiest way to verify is to check the voltage and the current phasor readings on the 369 relay and ensure that each respective voltage and current angles match.

**8. What are the merits of a residual ground fault connection versus a core balance connection?**

The use of a zero sequence (core balance) CT to detect ground current is recommended over the G/F residual connection. This is especially true at motor starting. During across-the-line starting of large motors, care must be taken to prevent the high inrush current from operating the ground element of the 369. This is especially true when using the residual connection of 2 or 3 CTs.

In a residual connection, the unequal saturation of the current transformers, size and location of motor, size of power system, resistance in the power system from the source to the motor, type of iron used in the motor core & saturation density, and residual flux levels may all contribute to the production of a false residual current in the secondary or relay circuit. The common practice in medium and high voltage systems is to use low resistance grounding. By using the "doughnut CT" scheme, such systems offer the advantages of speed and reliability without much concern for starting current, fault contribution by the motor, or false residual current.

When a zero sequence CT is used, a voltage is generated in the secondary winding only when zero sequence current is flowing in the primary leads. Since virtually all motors have their neutrals ungrounded, no zero sequence current can flow in the motor leads unless there is a ground fault on the motor side.

**9. Can I use an 86 lockout on the 369?**

Yes, but if an external 86 lockout device is used and connected to the 369, ensure the 369 is reset *prior* to attempting to reset the lockout switch. If the 369 is still tripped, it will immediately re-trip the lockout switch. Also, if the lockout switch is held reset, the high current draw of the switch coil may cause damage to itself and/or the 369 output relay.

**10. Can I assign more than one output relay to be blocked when using Start Inhibits?**

Yes, but keep in mind that if two output relays are wired in series to inhibit a start it is possible that another element could be programmed to control one or both of the relays. If this is happening and the other element is programmed with a longer delay time, this will make it seem as if the Start Inhibit is not working properly when in fact, it is.

**11. Can I name a digital input?**

Yes. By configuring the digital input as "General" a menu will appear that will allow naming.



**12. Can I apply an external voltage to the digital inputs on the 369?**

No. The 369 uses an internal voltage to operate the digital inputs. Applying an external voltage may cause damage to the internal circuitry.

**13. Can I upload setpoint files from previous versions to the latest version of firmware?**

Yes, with the exception of setpoint files from versions 1.10 and 1.12. Unfortunately these setpoint files must be rewritten, as they are not compatible.

**14. What method does the 369 use to calculate current unbalance?**

The 369 uses the NEMA method. Previous revisions of the 369 manual have incorrectly included a functional test that measured the ratio of negative sequence current to positive sequence current. The NEMA method is as follows:

$$\text{If } I_{avg} \geq I_{FLA}, \text{ then Unbalance} = \frac{I_{max} - I_{avg}}{I_{avg}} \times 100$$

where:  $I_{avg}$  = average phase current

$I_{max}$  = current in a phase with maximum deviation from  $I_{avg}$

$I_{FLA}$  = motor full load amps setting

$$\text{If } I_{avg} < I_{FLA}, \text{ then Unbalance} = \frac{I_{max} - I_{avg}}{I_{FLA}} \times 100$$

To prevent nuisance trips/alarms on lightly loaded motors when a much larger unbalance level will not damage the rotor, the unbalance protection will automatically be defeated if the average motor current is less than 30% of the full load current ( $I_{FLA}$ ) setting.

**15. I need to update the options for my 369/RRTD in the field, can I do this?**

Yes. All options of the 369/RRTD can be turned on or added in the field. To do this contact the factory.

**16. Can I test my output relays?**

Yes, but keep in mind that the output relays cannot be forced into a different state while the motor is running.

**17. Is the communication interface for Profibus RS232 or RS485?**

It is RS485. The 9-pin connector on the rear of the 369 is the connector used by the manufacturer of the Profibus card and although it is a DB-9, the electrical interface is RS485.

**18. Can I use the options enabler code to upgrade my 369 in the field to get the Profibus option?**

Yes, but keep in mind that there is a Profibus card that is required and is not installed in units that were not ordered from the factory with the Profibus option.

**19. Can the 369 be used as a remote unit, similar to the 269 remote?**

Yes. Every 369 can be used as remote. When ordering the 369, an external 15 foot cable must be ordered.

**20. Can the RRTD module be used as a standalone unit?**

Yes. The RRTD unit with the IO option, has 4 output relays, 6 digital inputs and 4 analog outputs. With this option the RRTD can provide temperature protection.

**21. Why is there a filter ground and a safety ground connection? Why are they separate?**

The safety ground ensures operator safety with regards to hazardous shocks; the filter ground protects the internal electronic circuitry from transient noise.

These two grounds are separated for hi-pot (dielectric strength) testing purposes. Both grounds should be tied to the ground bus external to the relay.

**22. 369 doesn't communicate with ethernet after change in IP address, what should I do?**

Cycle the power supply to the 369. In order to make the new IP address active the power supply of the 369 must be recycled after changing or setting the IP address of the relay.

## 7.3 369 Do's and Dont's

### 7.3.1 Do's and Dont's

#### Do's

##### **Always check the power supply rating before applying power to the relay**

Applying voltage greater than the maximum rating to the power supply (e.g. 120 V AC to the low-voltage rated power supply) could result in component damage to the relay's power supply. This will result in the unit no longer being able to power up.

##### **Ensure that the 369 nominal phase current of 1 A or 5 A matches the secondary rating and the connections of the connected CTs**

Unmatched CTs may result in equipment damage or inadequate protection.

##### **Ensure that the source CT and VT polarity match the relay CT and VT polarity**

Polarity of the Phase CTs is critical for power measurement, and residual ground current detection (if used). Polarity of the VTs is critical for correct power measurement and voltage phase reversal operation.

##### **Properly ground the 369**

Connect both the Filter Ground (terminal 123) and Safety Ground (terminal 126) of the 369 directly to the main GROUND BUS. The benefits of proper grounding of the 369 are numerous, e.g,

- Elimination of nuisance tripping
- Elimination of internal hardware failures
- Reliable operation of the relay
- Higher MTBF (Mean Time Between Failures)
- It is recommended that a tinned copper braided shielding and bonding cable be used. A Belden 8660 cable or equivalent should be used as a minimum to connect the relay directly to the ground bus.

##### **Grounding of Phase and Ground CTs**

All Phase and Ground CTs must be grounded. The potential difference between the CT's ground and the ground bus should be minimal (ideally zero).

It is highly recommended that the two CT leads be twisted together to minimize noise pickup, especially when the highly sensitive 50:0.025 Ground CT sensor is used.

#### RTDs

Consult the application notes of the 369 Instruction Manual for the full description of the 369 RTD circuitry and the different RTD wiring schemes acceptable for proper operation. However, for best results the following recommendations should be adhered to:

1. Use a 3 wire twisted, shielded cable to connect the RTDs from the motor to the 369. The shields should be connected to the proper terminals on the back of the 369.
2. RTD shields are internally connected to the 369 ground (terminal #126) and must not be grounded anywhere else.
3. RTD signals can be characterized as very small, sensitive signals. Therefore, cables carrying RTD signals should be routed as far away as possible from power carrying cables such as power supply and CT cables.
4. If after wiring the RTD leads to the 369, the RTD temperature displayed by the Relay is zero, then check for the following conditions:
  - a. Shorted RTD
  - b. RTD hot and compensation leads are reversed, i.e. hot lead in compensation terminal and compensation lead in hot terminal.

#### RS485 Communications Port

The 369 can provide direct or remote communications (via a modem). An RS232 to RS485 converter is used to tie it to a PC/PLC or DCS system. The 369 uses the Modicon MODBUS<sup>®</sup> RTU protocol (functions 03, 04, and 16) to interface with PCs, PLCs, and DCS systems.

RS485 communications was chosen to be used with the 369 because it allows communications over long distances of up to 4000 ft. However, care must be taken for it to operate properly and trouble free. The recommendations listed below must be followed to obtain reliable communications:

1. A twisted, shielded pair (preferably a 24 gauge Belden 9841 type or 120 equivalent) must be used and routed away from power carrying cables, such as power supply and CT cables.
2. No more than 32 devices can co-exist on the same link. If however, more than 32 devices should be daisy chained together, a REPEATER must be used. Note that a repeater is just another RS232 to RS485 converter device. The shields of all 369 units should also be daisy chained together and grounded at the MASTER (PC/PLC) only. This is due to the fact that if shields are grounded at different points, a potential difference between grounds might exist resulting in placing one or more of the transceiver chips (chip used for communications) in an unknown state, i.e. not receiving nor sending. The corresponding 369 communications might be erroneous, intermittent or unsuccessful.
3. Two sets of 120 ohm/ 0.5 W resistor and 1 nF / 50 V capacitor in series must be used (value matches the characteristic impedance of the line). One set at the 369 end, connected between the positive and negative terminals (#46 & #47 on 369) and the second at the other end of the communications link. This is to prevent reflections and ringing on the line. If a different value resistor is used, it runs the risk of over loading the line and communications might be erroneous, intermittent or totally unsuccessful.
4. It is highly recommended that connection from the 369 communication terminals be made directly to the interfacing Master Device (PC/PLC/DCS), without the use of stub lengths and/or terminal blocks. This is also to minimize ringing and reflections on the line.

## Don'ts

### **Don't apply direct voltage to the Digital Inputs.**

There are 6 switch inputs (Spare Input; Differential Input; Speed Switch; Access; Emergency Restart; External Reset) that are designed for dry contact connections only. Applying direct voltage to the inputs, it may result in component damage to the digital input circuitry.

### **Grounding of the RTDs should not be done in two places.**

When grounding at the 369, only one Return lead need be grounded as all are hard-wired together internally. No error will be introduced into the RTD reading by grounding in this manner.

Running more than one RTD Return lead back will cause significant errors as two or more parallel paths for return have been created.

### **Don't reset an 86 Lockout switch before resetting the 369.**

If an external 86 lockout device is used and connected to the 369, ensure that the 369 is reset **prior** to attempting to reset the lockout switch. If the 369 is still tripped, it will immediately re-trip the lockout switch. Also if the lockout switch is held reset, the high current draw of the lockout switch coil may cause damage to itself and/or the 369 output relay.

## 7.4 CT Specification and Selection

### 7.4.1 CT Specification

#### 369 CT Withstand

Withstand is important when the phase or ground CT has the capability of driving a large amount of current into the interposing CTs in the relay. This typically occurs on retrofit installations when the CTs are not sized to the burden of the relay. Electronic relays typically have low burdens ( $m\Omega$ ), while the older electromechanical relays have typically high burdens ( $1\ \Omega$ ).

For high current ground faults, the system will be either low resistance or solidly grounded. The limiting factor that determines the ground fault current that can flow in these types of systems is the source capacity. Withstand is **not** important for ground fault on high resistance grounded systems. On these systems, a resistor makes the connection from source to ground at the source (generator, transformer). The resistor value is chosen so that in the event of a ground fault, the current that flows is limited to a low value, typically 5, 10, or 20 A.

Since the potential for very large faults exists (ground faults on high resistance grounded systems excluded), the fault must be cleared as quickly as possible. It is therefore recommended that the time delay for short circuit and high ground faults be set to instantaneous. Then the duration for which the 369 CTs subjected to high withstand will be less than 250 ms (369 reaction time is less than 50ms + breaker clearing time).



**Care must be taken to ensure that the interrupting device is capable of interrupting the potential fault. If not, some other method of interrupting the fault should be used, and the feature in question should be disabled (e.g. a fused contactor relies on fuses to interrupt large faults).**

The 369 CTs were subjected to high currents for 1 second bursts. The CTs were capable of handling 500 A (500 A relates to a 100 times the CT primary rating). If the time duration required is less than 1 second, the withstand level will increase.

#### CT Size and Saturation

The rating (as per ANSI/IEEE C57.13.1) for relaying class CTs may be given in a format such as: 2.5C100, 10T200, T100, 10C50, or C200. The number preceding the letter represents the maximum ratio correction; no number in this position implies that the CT accuracy remains within a 10% ratio correction from 0 to 20 times rating.

The letter is an indication of the CT type:

- A 'C' (formerly L) represents a CT with a low leakage flux in the core where there is no appreciable effect on the ratio when used within the limits dictated by the class and rating. The 'C' stands for calculated; the actual ratio correction should be different from the calculated ratio correction by no more than 1%. A 'C' type CT is typically a bushing, window, or bar type CT with uniformly distributed windings.
- A 'T' (formerly H) represents a CT with a high leakage flux in the core where there is significant effect on CT performance. The 'T' stands for test; since the ratio correction is unpredictable, it is to be determined by test. A 'T' type CT is typically primary wound

with unevenly distributed windings. The subsequent number specifies the **secondary terminal voltage** that may be delivered by the full winding at 20 times rated secondary current without exceeding the ratio correction specified by the first number of the rating. (Example: a 10C100 can develop 100 V at  $20 \times 5$  A, therefore an appropriate external burden would be  $1 \Omega$  or *less* to allow 20 times rated secondary current with less than 10% ratio correction.) Note that the voltage rating is at the secondary terminals of the CT and the internal voltage drop across the secondary resistance must be accounted for in the design of the CT. There are seven voltage ratings: 10, 20, 50, 100, 200, 400, and 800. If a CT comes close to a higher rating, but does not meet or exceed it, then the CT must be rated to the lower value.

In order to determine how much current CTs can output, the secondary resistance of the CT is required. This resistance will be part of the equation as far as limiting the current flow. This is determined by the maximum voltage that may be developed by the CT secondary divided by the entire secondary resistance, CT secondary resistance included.

## 7.4.2 CT Selection

The 369 phase CT should be chosen such that the FLA (FLC) of the motor falls within 50 to 100% of the CT primary rating. For example, if the FLA of the motor is 173 A, a primary CT rating of 200, 250, or 300 can be chosen (200 being the better choice). This provides maximum protection of the motor.

The CT selected must then be checked to ensure that it can drive the attached burden (relay and wiring and any auxiliary devices) at maximum fault current levels without saturating. There are essentially two ways of determining if the CT is being driven into saturation:

### 1. Use CT secondary resistance

Burden = CT secondary resistance + Wire resistance + Relay burden resistance

$$\text{CT secondary voltage} = \text{Burden} \times \frac{I_{\text{fault maximum}}}{\text{CT ratio}}$$

#### Example:

Maximum fault level = 6 kA

369 burden =  $0.003 \Omega$

CT = 300:5

CT secondary resistance =  $0.088 \Omega$

Wire length (1 lead) = 50 m

Wire Size =  $4.00 \text{ mm}^2$

Ohms/km =  $4.73 \Omega$

$$\therefore \text{Burden} = 0.088 + (2 \times 50)(4.73 / 1000) + 0.003 = 0.564 \Omega$$

$$\therefore \text{CT secondary voltage} = 0.564 \times (6000 / (300 / 5)) = 56.4 \text{ V}$$

Using the excitation curves for the 300:5 CT we see that the knee voltage is at 70 V, therefore this CT is acceptable for this application.

### 2. Use CT class

Burden = Wire resistance + Relay burden resistance

$$\text{CT secondary voltage} = \text{Burden} \times \frac{I_{\text{fault maximum}}}{\text{CT ratio}}$$

**Example:**

Maximum fault level = 6 kA, 369 burden = 0.003  $\Omega$ , CT = 300:5, CT class = C20,  
Wire length (1 lead) = 50 m, Wire Size = 4.00 mm<sup>2</sup>, Ohms/km = 4.73  $\Omega$

$$\therefore \text{Burden} = (2 \times 50) \times (4.73/1000) + 0.003 = 0.476 \Omega$$

$$\therefore \text{CT secondary voltage} = 0.476 \times (6000 / (300 / 5)) = 47.6 \text{ V}$$

From the CT class (C20): The amount of secondary voltage the CT can deliver to the load burden at 20  $\times$  CT without exceeding the 10% ratio error is 20 V. This application calls for 6000/300 = 20  $\times$  CT (Fault current / CT primary). Thus the 10% ratio error may be exceeded.

The number in the CT class code refers to the guaranteed secondary voltage of the CT. Therefore, the maximum current that the CT can deliver can be calculated as follows:

$$\text{maximum secondary current} = \text{CT class} / \text{Burden} = 20 / 0.476 = 42.02 \text{ A}$$

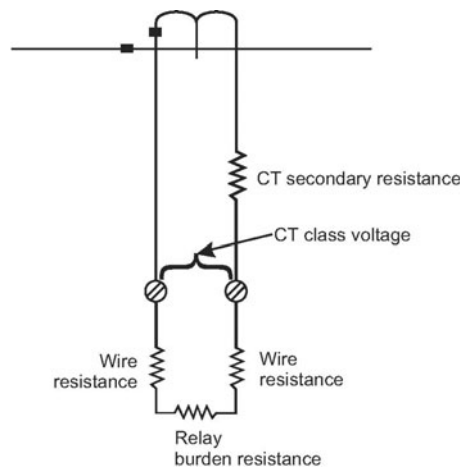

**FIGURE 7-1: Equivalent CT Circuit**



## 7.5 Programming Example

### 7.5.1 Programming Example

Information provided by a motor manufacturer can vary from nameplate information to a vast amount of data related to every parameter of the motor. The table below shows selected information from a typical motor data sheet and FIGURE 7-2: Motor Thermal Limits shows the related motor thermal limit curves. This information is required to set the 369 for a proper protection scheme.

**The following is an example of how to determine the 369 setpoints. It is only an example and the setpoints should be determined based on the application and specific design of the motor.**

**Table 7-2: Selected Information from a Typical Motor Data Sheet**

<b>Driven equipment</b>	Reciprocating Compressor
<b>Ambient Temperature</b>	min. -20°C; max. 41°C
<b>Type or Motor</b>	Synchronous
<b>Voltage</b>	6000 V
<b>Nameplate power</b>	2300 kW
<b>Service Factor</b>	1
<b>Insulation class</b>	F
<b>Temperature rise stator / rotor</b>	79 / 79 K
<b>Max. locked rotor current</b>	550% FLC
<b>Locked rotor current% FLC</b>	500% at 100% Voltage / 425% at 85% Voltage
<b>Starting time</b>	4 seconds at 100% Voltage / 6.5 seconds at 85% Voltage
<b>Max. permissible starts cold / hot</b>	3 / 2
<b>Rated Load Current</b>	229A at 100% Load

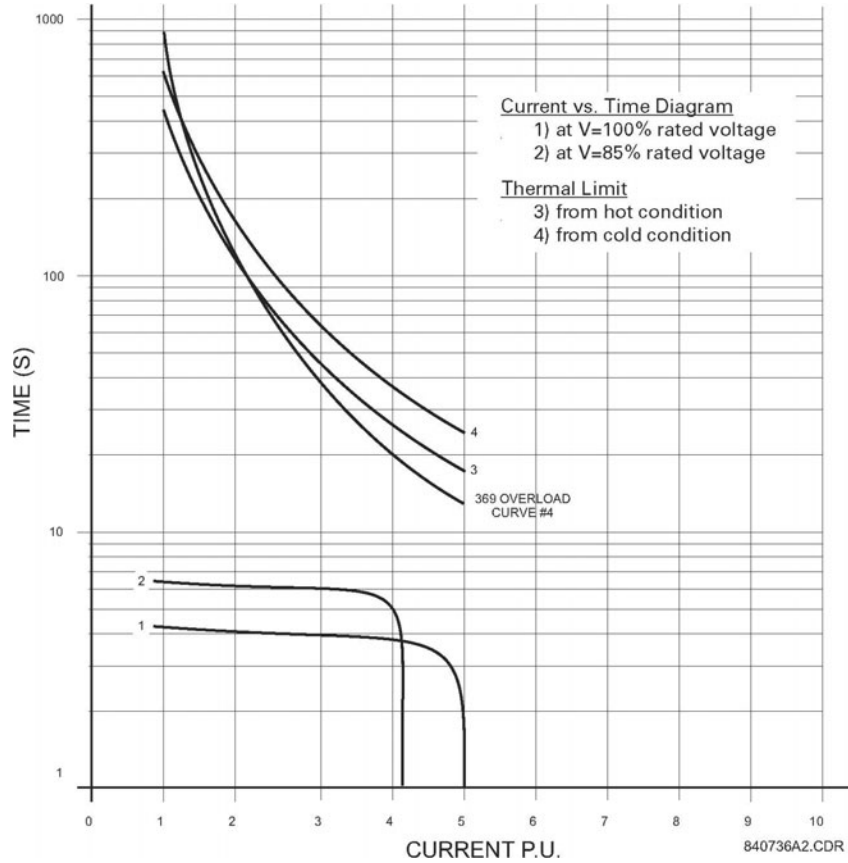

FIGURE 7-2: Motor Thermal Limits

**Phase CT**

The phase CT should be chosen such that the FLC is 50% to 100% of CT primary. Since the FLC is 229 A a 250:5, 300:5, or 400:5 CT may be chosen (a 250:5 is the better choice).

$$229 / 0.50 = 458 \quad \text{or} \quad 229 / 1.00 = 229$$

**Motor FLC**

Set the Motor Full Load Current to 229A, as per data sheets.

**Ground CT**

For high resistive grounded systems, sensitive ground detection is possible with the 50:0.025 CT. On solidly grounded or low resistive grounded systems where the fault current is much higher, a 1A or 5A CT should be used. If residual ground fault connection is to be used, the ground fault CT ratio must equal the phase CT ratio. The zero sequence CT chosen needs to be able to handle all potential fault levels without saturating.

**VT Settings**

The motor is going to be connected in Wye, hence, the VT connection type will be programmed as Wye. Since the motor voltage is 6000V, the VT being used will be 6000:120. The VT ratio to be programmed into the 369 will then be 50:1 (6000/120) and the Motor Rated Voltage will be programmed to 6000V, as per the motor data sheets.

**Overload Pickup**

The overload pickup is set to the same as the service factor of the motor. In this case, it would be set to the lowest setting of  $1.01 \times \text{FLC}$  for the service factor of 1.

**Unbalance Bias Of Thermal Capacity**

Enable the Unbalance Bias of Thermal Capacity so that the heating effect of unbalance currents is added to the Thermal Capacity Used.

**Unbalance Bias K Factor**

The K value is used to calculate the contribution of the negative sequence current flowing in the rotor due to unbalance. It is defined as:

$$\frac{R_{r2}}{R_{r1}}, \text{ where: } R_{r2} = \text{rotor negative sequence resistance, } R_{r1} = \text{rotor positive sequence resistance}$$

$$K = \frac{175}{L_{RA}^2} = \frac{175}{5.5^2} @ 6$$

where:  $L_{RA}$  = Locked Rotor Current



NOTE

The above formula is based on empirical data.

The 369 has the ability to learn the K value after five successful starts. After 5 starts, turn this setpoint off so that the 369 uses the learned value

**Hot/Cold Curve Ratio**

The hot/cold curve ratio is calculated by simply dividing the hot safe stall time by the cold safe stall time. This information can be extracted from the Thermal Limit curves. From FIGURE 7-2: *Motor Thermal Limits*, we can determine that the hot safe stall time is approximately 18 seconds and the cold safe stall time is approximately 24 seconds. Therefore, the Hot/Cold curve ratio should be programmed as 0.75 (18 / 24) for this example.

**Running and Stopped Cool Time Constant**

The running cool time is the time required for the motor to cool while running. This information is usually supplied by the motor manufacturer but is not part of the given data. The motor manufacturer should be contacted to find out what the cool times are.

The Thermal Capacity Used quantity decays exponentially to simulate the cooling of the motor. The rate of cooling is based upon the running cool time constant when the motor is running, or the stopped cool time constant when the motor is stopped. The entered cool time constant is one fifth the total cool time from 100% thermal capacity used down to 0% thermal capacity used.

The 369 has a unique capability of learning the cool time constant. This learned parameter is only functional if the Stator RTDs are connected to the 369. The learned cool time algorithm observes the temperature of the motor as it cools, thus determining the length of time required for cooling. If the cool times can not be retrieved from the motor manufacturer, then the Learned Cool Time must be enabled (if the stator RTDs are connected).

Motors have a fanning action when running due to the rotation of the rotor. For this reason, the running cool time is typically half of the stopped cool time.

Refer to the Selection of Cool Time application note for more details on how to determine the cool time constants when not provided with the motor.

### **RTD Biasing**

This will enable the temperature from the Stator RTD sensors to be included in the calculations of Thermal Capacity. This model determines the Thermal Capacity Used based on the temperature of the Stators and is a separate calculation from the overload model for calculating Thermal Capacity Used. RTD biasing is a back up protection element which accounts for such things as loss of cooling or unusually high ambient temperature. There are three parameters to set: RTD Bias Min, RTD Bias Mid, RTD Bias Max.

#### **RTD Bias Minimum**

Set to 40°C which is the ambient temperature (obtained from data sheets).

#### **RTD Bias Mid Point**

The center point temperature is set to the motor's hot running temperature and is calculated as follows:

Temperature Rise of Stator + Ambient Temperature.

The temperature rise of the stator is 79°K, obtained from the data sheets. Therefore, the RTD Center point temperature is set to 120°C (79 + 40).

#### **RTD Bias Maximum**

This setpoint is set to the rating of the insulation or slightly less. A class F insulation is used in this motor which is rated at 155°C.

### **Overload Curve**

If only one thermal limit curve is provided, the chosen overload curve should fit below it. When a hot and cold thermal limit curve is provided, the chosen overload curve should fit between the two curves and the programmed Hot/Cold ratio is used in the Thermal Capacity algorithm to take into account the thermal state of the motor. The best fitting 369 standard curve is curve # 4, as seen in FIGURE 7-2: *Motor Thermal Limits* on page 7-234.

### **Short Circuit Trip**

The short circuit trip should be set above the maximum locked rotor current but below the short circuit current of the fuses. The data sheets indicate a maximum locked rotor current of 550% FLC or 5.5 × FLC. A setting of 6 × FLC with a instantaneous time delay will be ideal but nuisance tripping may result due to unusually high demanding starts or starts while the load is coupled. If need be, set the S/C level higher to a maximum of 8 × FLC to override these conditions.

### **Mechanical Jam**

If the process causes the motor to be prone to mechanical jams, set the Mechanical Jam Trip and Alarm accordingly. In most cases, the overload trip will become active before the Mechanical Trip, however, if a high overload curve is chosen, the Mechanical Jam level and time delay become more critical. The setting should then be set to below the overload curve but above any normal overload conditions of the motor. The main purpose of the mechanical jam element is to protect the driven equipment due to jammed, or broken equipment.

**Undercurrent**

If detection of loss of load is required for the specific application, set the undercurrent element according to the current that will indicate loss of load. For example, this could be programmed for a pump application to detect loss of fluid in the pipe.

**Unbalance Alarm and Trip**

The unbalance settings are determined by examining the motor application and motor design. In this case, the motor being protected is a reciprocating compressor, in which unbalance will be a normal running condition, thus this setting should be set high. A setting of 20% for the Unbalance Alarm with a delay of 10 seconds would be appropriate and the trip may be set to 25% with a delay of 10 seconds

**Ground Fault**

Unfortunately, there is not enough information to determine a ground fault setting. These settings depend on the following information:

1. The Ground Fault current available.
2. System Grounding - high resistive grounding, solidly grounded, etc.
3. Ground Fault CT used.
4. Ground Fault connection - zero sequence or Residual connection.

**Acceleration Trip**

This setpoint should be set higher than the maximum starting time to avoid nuisance tripping when the voltage is lower or for varying loads during starting. If reduced voltage starting is used, a setting of 8 seconds would be appropriate, or if direct across the line starting is used, a setting of 5 seconds could be used.

**Start Inhibit**

This function should always be enabled after five successful starts to protect the motor during starting while it is already hot. The 369 learns the amount of thermal capacity used at start. If the motor is hot, thus having some thermal capacity, the 369 will not allow a start if the available thermal capacity is less than the required thermal capacity for a start. For more information regarding start inhibit refer to application note in section 7.6.6.

**Starts/Hour**

Starts/Hour can be set to the # of cold starts as per the data sheet. For this example, the starts/hour would be set to 3.

**Time Between Starts**

In some cases, the motor manufacturer will specify the time between motor starts. In this example, this information is not given so this feature can be turned "Off". However, if the information is given, the time provided on the motor data sheets should be programmed.

**Stator RTDs**

RTD trip level should be set at or below the maximum temperature rating of the insulation. This example has a class F insulation which has a temperature rating of 155°C, therefore the Stator RTD Trip level should be set to between 140°C to 155°C. The RTD alarm level should be set to a level to provide a warning that the motor temperature is rising. For this example, 120°C or 130°C would be appropriate.

**Bearing RTDs**

The Bearing RTD alarm and trip settings will be determined by evaluating the temperature specification from the bearing manufacturer.

---

## 7.6 Applications

### 7.6.1 Motor Status Detection

The 369 detects a stopped motor condition when the phase current falls below 5% of CT, and detects a starting motor condition when phase current is sensed after a stopped motor condition. If the motor idles at 5% of CT, several starts and stops can be detected causing nuisance lockouts if Starts/Hour, Time Between Starts, Restart Block, Start Inhibit, or Backspin Timer are programmed. As well, the learned values, such as the Learned Starting Thermal Capacity, Learned Starting Current and Learned Acceleration time can be incorrectly calculated.

To overcome this potential problem, the Spare Digital Input can be configured to read the status of the breaker and determine whether the motor is stopped or simply idling. With the spare input configured as Starter Status and the breaker auxiliary contacts wired across the spare input terminals, the 369 senses a stopped motor condition only when the phase current is below 5% of CT (or zero) AND the breaker is open. If both of these conditions are not met, the 369 will continue to operate as if the motor is running and the starting elements remain unchanged. Refer to the flowchart below for details of how the 369 detects motor status and how the starter status element further defines the condition of the motor.

When the Starter Status is programmed, the type of breaker contact being used for monitoring must be set. The following are the states of the breaker auxiliary contacts in relation to the breaker:

- 52a, 52aa - open when the breaker contacts are open and closed when the breaker contacts are closed
- 52b, 52bb - closed when the breaker contacts are open and open when the breaker contacts are closed

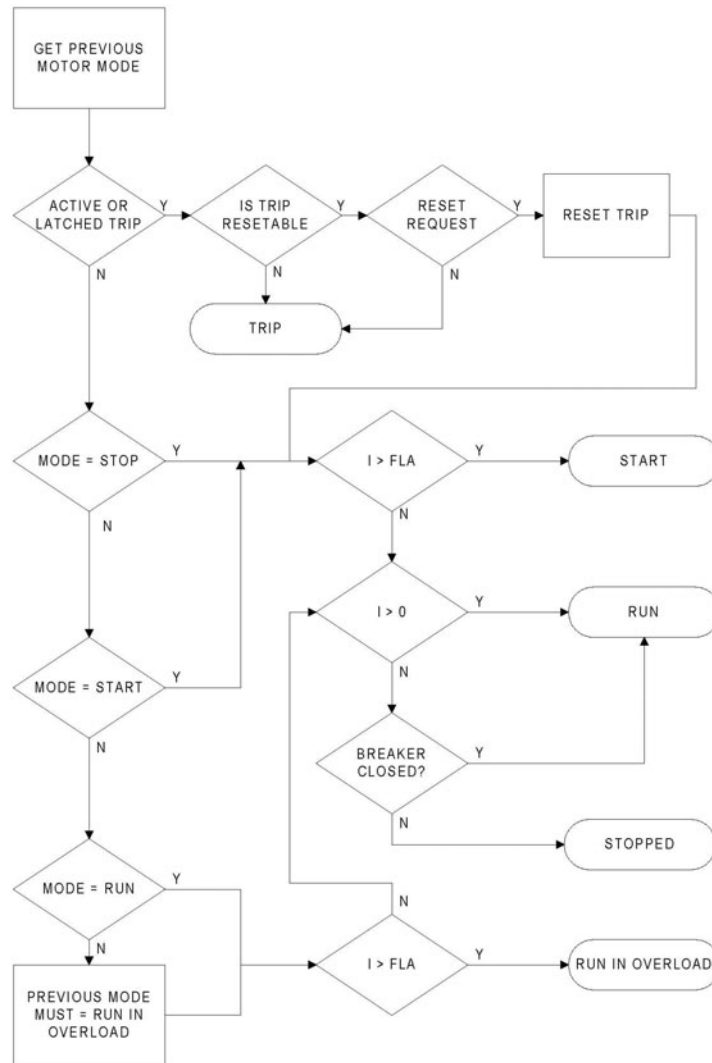

FIGURE 7-3: Flowchart Showing How Motor Status is Determined

### 7.6.2 Selection of Cool Time Constants

Thermal limits are not a black and white science and there is some art to setting a protective relay thermal model. The definition of thermal limits mean different things to different manufacturers and quite often, information is not available. Therefore, it is important to remember what the goal of the motor protection thermal modeling is: to thermally protect the motor (rotor and stator) without impeding the normal and expected operating conditions that the motor will be subject to.

The thermal model of the 369 provides integrated rotor and stator heating protection. If cooling time constants are supplied with the motor data they should be used. Since the rotor and stator heating and cooling is integrated into a single model, use the longer of the cooling time constants (rotor or stator).



If however, no cooling time constants are provided, settings will have to be determined. Before determining the cool time constant settings, the duty cycle of the motor should be considered. If the motor is typically started and run continuously for very long periods of time with no overload duty requirements, the cooling time constants can be large. This would make the thermal model conservative. If the normal duty cycle of the motor involves frequent starts and stops with a periodic overload duty requirement, the cooling time constants will need to be shorter and closer to the actual *thermal limit* of the motor.

Normally motors are rotor limited during starting. Thus RTDs in the stator do not provide the best method of determining cool times. Determination of reasonable settings for the running and stopped cool time constants can be accomplished in one of the following manners listed in order of preference.

1. The motor running and stopped cool times or constants may be provided on the motor data sheets or by the manufacturer if requested. Remember that the cooling is exponential and the time constants are one fifth the total time to go from 100% thermal capacity used to 0%.
2. Attempt to determine a conservative value from available data on the motor. See the following example for details.
3. If no data is available an educated guess must be made. Perhaps the motor data could be estimated from other motors of a similar size or use. Note that conservative protection is better as a first choice until a better understanding of the motor requirements is developed. Remember that the goal is to protect the motor without impeding the operating duty that is desired.

**Example:**

Motor data sheets state that the starting sequence allowed is 2 cold or 1 hot after which you must wait 5 hours before attempting another start.

- This implies that under a normal start condition the motor is using between 34 and 50% thermal capacity. Hence, two consecutive starts are allowed, but not three (i.e.  $34 \times 3 > 100$ ).
- If the hot and cold curves or a hot/cold safe stall ratio are not available program 0.5 (1 hot / 2 cold starts) in as the hot/cold ratio.
- Programming *Start Inhibit 'On'* makes a restart possible as soon as 62.5% ( $50 \times 1.25$ ) thermal capacity is available.
- After 2 cold or 1 hot start, close to 100% thermal capacity will be used. Thermal capacity used decays exponentially (see 369 manual section on motor cooling for calculation). There will be only 37% thermal capacity used after 1 time constant which means there is enough thermal capacity available for another start. Program 60 minutes (5 hours) as the *stopped cool time constant*. Thus after 2 cold or 1 hot start, a stopped motor will be blocked from starting for 5 hours.

Since the rotor cools faster when the motor is running, a reasonable setting for the running cool time constant might be half the stopped cool time constant or 150 minutes.

7.6.3 Thermal Model

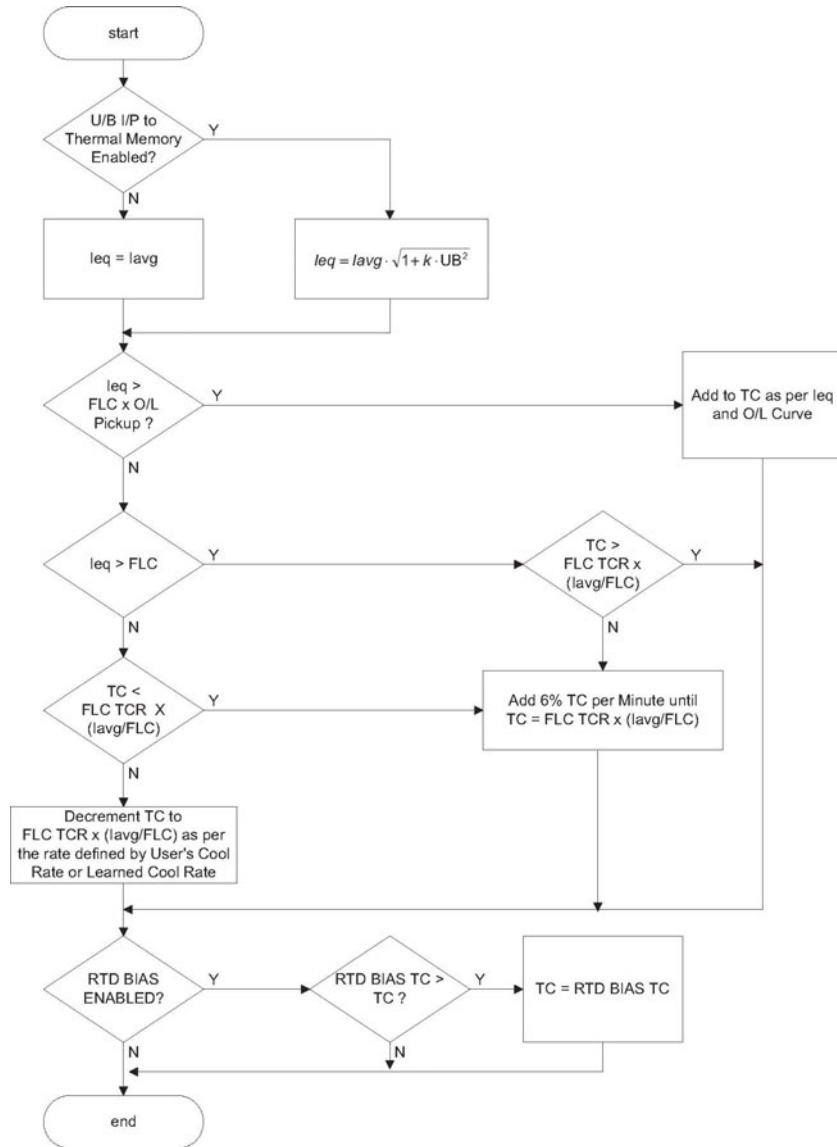

FIGURE 7-4: Thermal Model Block Diagram

UB, U/BUbalance

I/PIinput

IavgAverage Three Phase Current

IeqEquivalent Average Three Phase Current

IpPositive Sequence Current

InNegative Sequence Current

KConstant Multiplier that Equates In to Ip

FLCFull Load Current

FLC TCRFLC Thermal Capacity Reduction setpoint  
 TC Thermal Capacity used  
 RTD BIAS TCTC Value looked up from RTD Bias Curve



If Unbalance input to thermal memory is enabled, the increase in heating is reflected in the thermal model. If RTD Input to Thermal Memory is enabled, the feed-back from the RTDs will correct the thermal model.

7.6.4 RTD Bias Feature

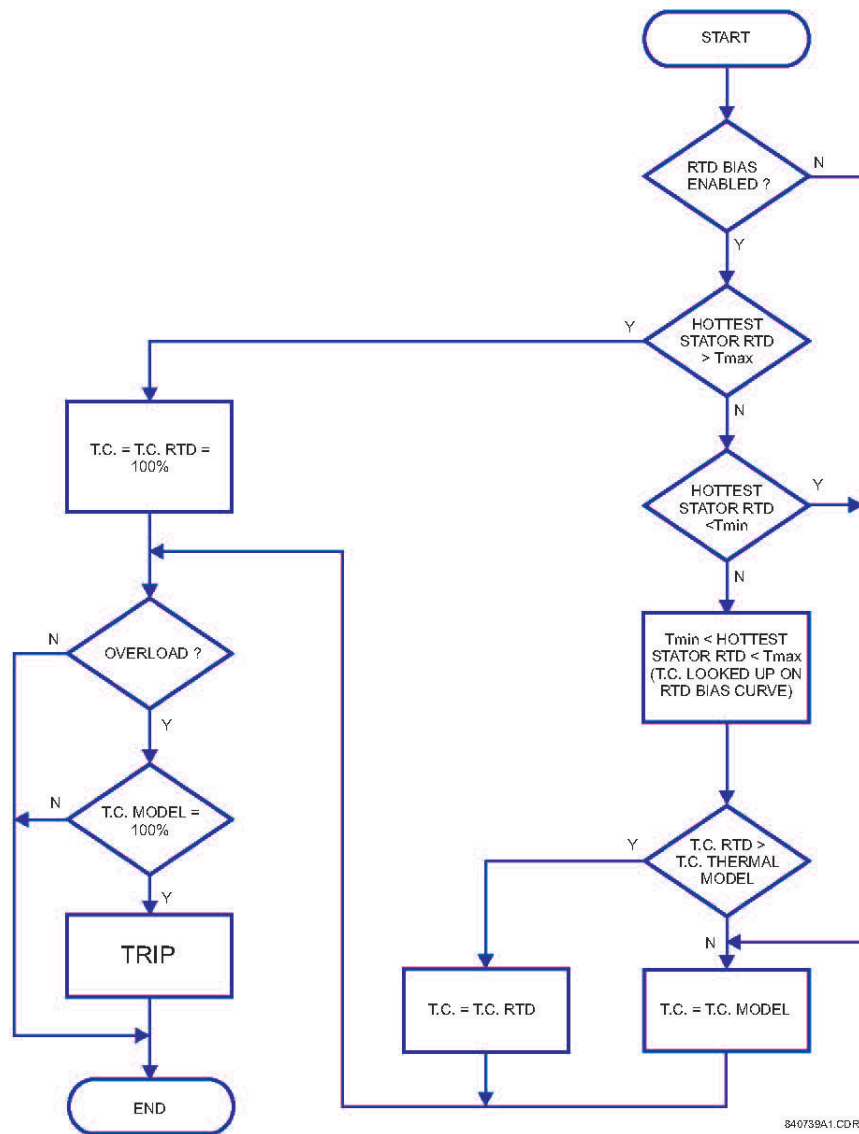

840799A1.CDR

FIGURE 7-5: RTD Bias Feature

**Legend**

- TmaxRTD Bias Maximum Temperature Value
- TminRTD Bias Minimum Temperature Value
- Hottest RTDHottest Stator RTD measured
- TCThermal Capacity Used
- TC RTDThermal Capacity Looked up on RTD Bias Curve.
- TC ModelThermal Capacity based on the Thermal Model

**7.6.5 Thermal Capacity Used Calculation**

The overload element uses a Thermal Capacity algorithm to determine an overload trip condition. The extent of overload current determines how fast the Thermal Memory is filled, i.e. if the current is just over FLC × O/L Pickup, Thermal Capacity slowly increases; versus if the current far exceeds the FLC pickup level, the Thermal Capacity rapidly increases. An overload trip occurs when the Thermal Capacity Used reaches 100%.

The overload current does not necessarily have to pass the overload curve for a trip to take place. If there is Thermal Capacity already built up, the overload trip will occur much faster. In other words, the overload trip will occur at the specified time on the curve only when the Thermal Capacity is equal to zero and the current is applied at a stable rate. Otherwise, the Thermal Capacity increases from the value prior to overload, until a 100% Thermal Capacity is reached and an overload trip occurs.

It is important to chose the overload curve correctly for proper protection. In some cases it is necessary to calculate the amount of Thermal Capacity developed after a start. This is done to ensure that the 369 does not trip the motor prior to the completion of a start. The actual filling of the Thermal Capacity is the area under the overload current curve. Therefore, to calculate the amount of Thermal Capacity after a start, the integral of the overload current must be calculated. Below is an example of how to calculate the Thermal Capacity during a start:

**Thermal Capacity Calculation:**

4. Draw lines intersecting the acceleration curve and the overload curve. This is illustrated in FIGURE 7-6: *Thermal Limit Curves* on page 7-246.
5. Determine the time at which the drawn line intersect, the acceleration curve and the time at which the drawn line intersects the chosen overload curve.
6. Integrate the values that have been determined.

**Table 7-3: Thermal Capacity Calculations**

Time Period (seconds)	Motor Starting Current (% of FLC)	Custom Curve Trip Time (seconds)	Total Accumulated Thermal Capacity Used (%)
0 to 3	580	38	$3 / 38 \times 100 = 7.8\%$
3 to 6	560	41	$(3 / 41 \times 100) + 7.8\% = 15.1\%$
6 to 9	540	44	$(3 / 44 \times 100) + 15.1\% = 21.9\%$

Table 7-3: Thermal Capacity Calculations

Time Period (seconds)	Motor Starting Current (% of FLC)	Custom Curve Trip Time (seconds)	Total Accumulated Thermal Capacity Used (%)
9 to 12	520	47	$(3 / 47 \times 100) + 21.9\% = 28.3\%$
12 to 14	500	51	$(2 / 51 \times 100) + 28.3\% = 32.2\%$
14 to 15	480	56	$(1 / 56 \times 100) + 32.2\% = 34.0\%$
15 to 16	460	61	$(1 / 61 \times 100) + 34.0\% = 35.6\%$
16 to 17	440	67	$(1 / 67 \times 100) + 35.6\% = 37.1\%$
17 to 18	380	90	$(1 / 90 \times 100) + 37.1\% = 38.2\%$
18 to 19	300	149	$(1 / 149 \times 100) + 38.2\% = 38.9\%$
19 to 20	160	670	$(1 / 670 \times 100) + 38.9\% = 39.0\%$

Therefore, after this motor has completed a successful start, the Thermal Capacity would have reached approximately 40%.

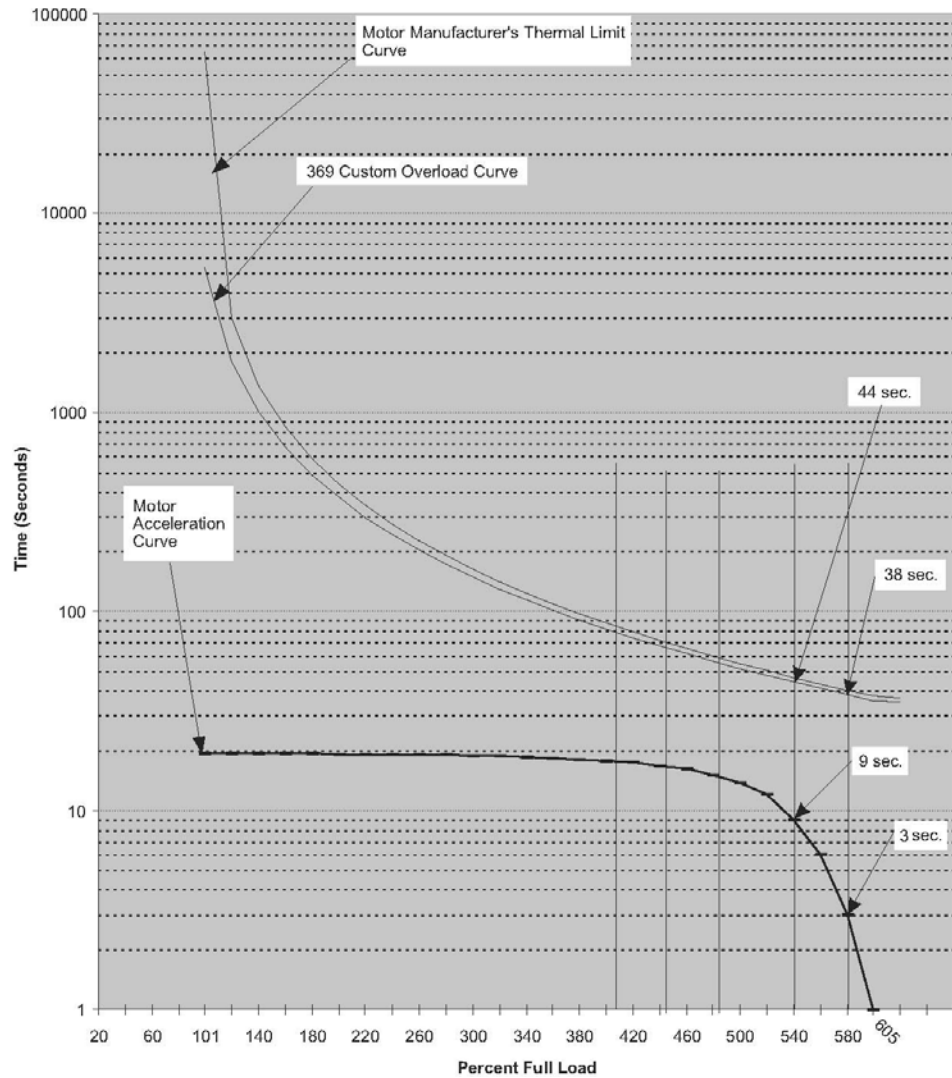

FIGURE 7-6: Thermal Limit Curves

Thermal limit curves illustrate thermal capacity used calculation during a start.

### 7.6.6 Start Inhibit

The Start Inhibit element of the 369 provides an accurate and reliable start protection without unnecessary prolonged lockout times causing production down time. The lockout time is based on the actual performance and application of the motor and not on the worst case scenario, as other start protection elements.

The 369 Thermal Capacity algorithm is used to establish the lockout time of the Start Inhibit element. Thermal Capacity is a percentage value that gives an indication of how hot the motor is and is derived from the overload currents (as well as Unbalance currents and RTDs if the respective biasing functions are enabled). The easiest way to understand the

Thermal Modeling function of the 369 is to image a bucket that holds Thermal Capacity. Once this imaginary bucket is full, an overload trip occurs. The bucket is filled by the amount of overload current integrated over time and is compared to the programmed overload curve to obtain a percentage value. The thermal capacity bucket is emptied based on the programmed running cool time when the current has fallen below the Full Load Current (FLC) and is running normally.

Upon a start, the inrush current is very high, causing the thermal capacity to rapidly increase. The Thermal Capacity Used variable is compared to the amount of the Thermal Capacity required to start the motor. If there is not enough thermal capacity available to start the motor, the 369 blocks the operator from starting until the motor has cooled to a level of thermal capacity to successfully start.

Assume that a motor requires 40% Thermal Capacity to start. If the motor was running in overload prior to stopping, the thermal capacity would be some value; say 80%. Under such conditions the 369 (with Start Inhibit enabled) will lockout or prevent the operator from starting the motor until the thermal capacity has decreased to 60% so that a successful motor start can be achieved. This example is illustrated in FIGURE 7-7: *Illustration of the Start Inhibit Functionality* on page 7-248.

The lockout time is calculated as follows:

$$\text{lockout time} = \text{stopped\_cool\_time\_constant} \times \ln\left(\frac{\text{TC}_{\text{used}}}{100 - \text{TC}_{\text{learned}}}\right) \quad (\text{EQ 7.1})$$

where:

$$\begin{aligned} \text{TC}_{\text{used}} &= \text{Thermal Capacity Used} \\ \text{TC}_{\text{learned}} &= \text{Learned Thermal Capacity required to start} \\ &= \text{one of two variables will be used:} \\ \text{stopped\_cool\_time} &\quad \begin{array}{l} 1. \text{ Learned cool time is enabled, or} \\ 2. \text{ Programmed stopped cool time} \end{array} \end{aligned}$$

The learned start capacity is updated every four starts. A safe margin is built into the calculation of the **LEARNED START CAPACITY REQUIRED** to ensure successful completion of the longest and most demanding starts. The Learned Start Capacity is calculated as follows:

$$\text{LEARNED START CAPACITY} = \frac{\text{Start\_TC1} + \text{Start\_TC2} + \text{Start\_TC3} + \text{Start\_TC4} + \text{Start\_TC5}}{4} \quad (\text{EQ 7.2})$$

where: Start\_TC1 = the thermal capacity required for the first start  
Start\_TC2 = the thermal capacity required for the second start, etc.

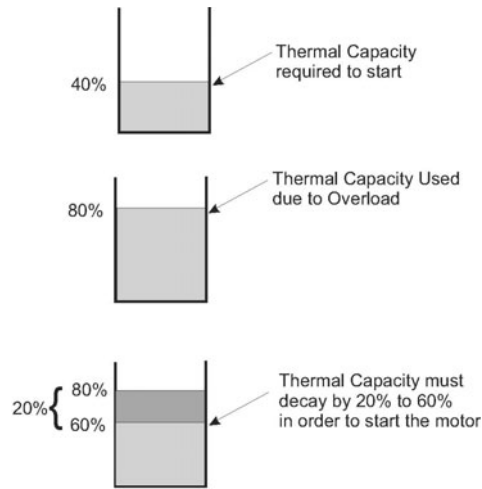

FIGURE 7-7: Illustration of the Start Inhibit Functionality

### 7.6.7 Two-Phase CT Configuration

This section illustrates how to use two CTs to sense three phase currents.

The proper configuration for using two CTs rather than three to detect phase current is shown below. Each of the two CTs acts as a current source. The current from the CT on phase 'A' flows into the interposing CT on the relay marked 'A'. From there, it sums with the current flowing from the CT on phase 'C' which has just passed through the interposing CT on the relay marked 'C'. This 'summed' current flows through the interposing CT marked 'B' and splits from there to return to its respective source (CT). **Polarity is very important since the value of phase 'B' must be the negative equivalent of 'A' + 'C' for the sum of all the vectors to equate to zero.** Note that there is only one ground connection. Making two ground connections creates a parallel path for the current

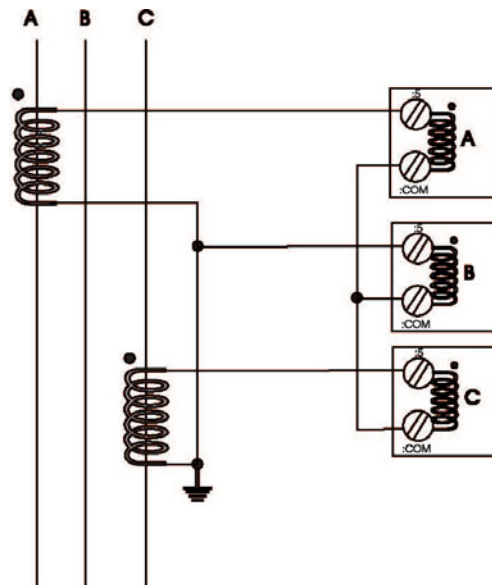

FIGURE 7-8: Two Phase Wiring



In the two CT configuration, the currents sum vectorially at the common point of the two CTs. The following diagram illustrates the two possible configurations. If one phase is reading high by a factor of 1.73 on a system that is known to be balanced, simply reverse the polarity of the leads at one of the two phase CTs (taking care that the CTs are still tied to ground at some point). **Polarity is important.**

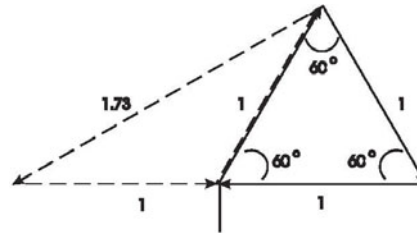

FIGURE 7-9: Vectors Showing Reverse Polarity

To illustrate the point further, the diagram here shows how the current in phases 'A' and 'C' sum up to create phase 'B'.

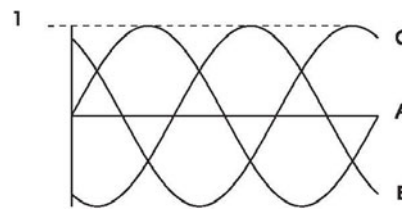

FIGURE 7-10: Resultant Phase Current, Correctly Wired Two-Phase CT System

Once again, if the polarity of one of the phases is out by 180°, the magnitude of the resulting vector on a balanced system will be out by a factor of 1.73.

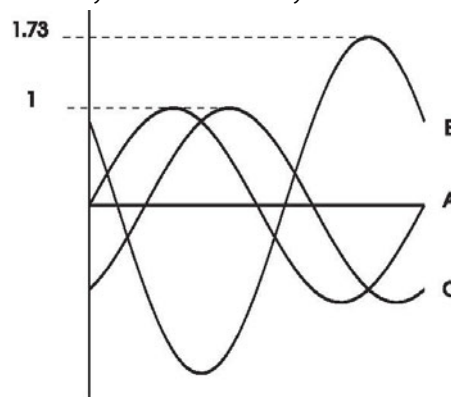

FIGURE 7-11: Resultant Phase Current, Incorrectly Wired Two-Phase CT System

On a three wire supply, this configuration will always work and unbalance will be detected properly. In the event of a single phase, there will always be a large unbalance present at the interposing CTs of the relay. If for example phase 'A' was lost, phase 'A' would read zero

while phases 'B' and 'C' would both read the magnitude of phase 'C'. If on the other hand, phase 'B' was lost, at the supply, 'A' would be 180° out of phase with phase 'C' and the vector addition would be zero at phase 'B'.

### 7.6.8 Ground Fault Detection on Ungrounded Systems

The 50:0.025 ground fault input is designed for sensitive detection of faults on a high resistance grounded system. Detection of ground currents from 1 to 10 A primary translates to an input of 0.5 mA to 5 mA into the 50:0.025 tap. Understanding this allows the use of this input in a simple manner for the detection of ground faults on ungrounded systems.

The following diagram illustrates how to use a wye-open delta voltage transformer configuration to detect phase grounding. Under normal conditions, the net voltage of the three phases that appears across the 50:0.025 input and the resistor is close to zero. Under a fault condition, assuming the secondaries of the VTs to be 69 V, the net voltage seen by the relay and the resistor is  $3V_0$  or  $3 \times 69 \text{ V} = 207 \text{ V}$ .

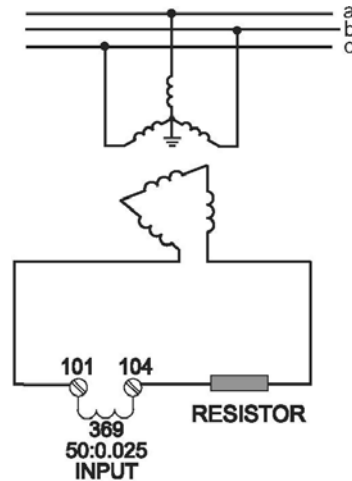

FIGURE 7-12: Ground Fault Detection on Ungrounded Systems

Since the wire resistance should be relatively small in comparison to the resistor chosen, the current flow will be a function of the fault voltage seen on the open delta transformer divided by the chosen resistor value plus the burden of the 50:0.025 input (1200 Ω).

#### Example:

If a pickup range of 10 to 100 V is desired, the resistor should be chosen as follows:

- 1 to 10 A pickup on the 2000:1 tap = 0.5 mA – 5 mA.
- $10 \text{ V} / 0.5 \text{ mA} = 20 \text{ k}\Omega$ .
- If the resistor chosen is  $20 \text{ k}\Omega - 1.2 \text{ k}\Omega = 18.8 \text{ k}\Omega$ , the wattage should be greater than  $E^2/R$ , approximately  $(207 \text{ V})^2 / 18.8 \text{ k}\Omega = 2.28 \text{ W}$ . Therefore, a 5 W resistor will suffice.



The VTs must have a primary rating equal or greater than the line to line voltage, as this is the voltage that will be seen by the unfaulted inputs in the event of a fault.

### 7.6.9 RTD Circuitry

This section illustrates the functionality of the RTD circuitry in the 369 Motor Protection Relay.

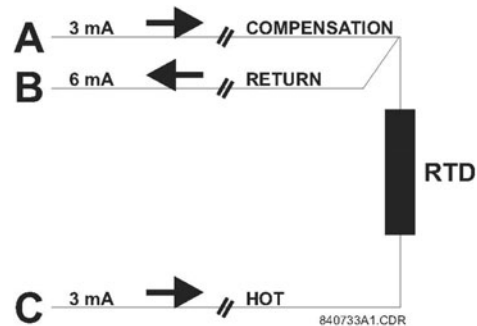

FIGURE 7-13: RTD Circuitry

A constant current source sends 3 mA DC down legs A and C. A 6 mA DC current returns down leg B. It may be seen that:

$$(V_{AB} = V_{LeadA} + V_{LeadB}) \quad \text{and} \quad V_{CB} = V_{LeadC} + V_{RTD} + V_{LeadB} \quad \text{(EQ 7.3)}$$

or

$$(V_{AB} = V_{comp} + V_{return}) \quad \text{and} \quad V_{CB} = V_{hot} + V_{RTD} + V_{return} \quad \text{(EQ 7.4)}$$

The above holds true providing that all three leads are the same length, gauge, and material, hence the same resistance.

$$R_{LeadA} = R_{LeadB} = R_{LeadC} = R_{Lead} \quad \text{(EQ 7.5)}$$

or

$$R_{comp} = R_{return} = R_{hot} = R_{Lead} \quad \text{(EQ 7.6)}$$

Electronically, subtracting  $V_{AB}$  from  $V_{BC}$  leaves only the voltage across the RTD. In this manner lead length is effectively negated:

$$\begin{aligned} V_{CB} - V_{AB} &= (V_{Lead} + V_{RTD} + V_{Lead}) - (V_{Lead} + V_{Lead}) \\ V_{CB} - V_{AB} &= V_{RTD} \end{aligned} \quad \text{(EQ 7.7)}$$

### 7.6.10 Reduced RTD Lead Number Application

The 369 requires three leads to be brought back from each RTD: Hot, Return, and Compensation. In certain situations this can be quite expensive. However, it is possible to reduce the number of leads so that three are required for the first RTD and only one for each successive RTD. Refer to the following diagram for wiring configuration.

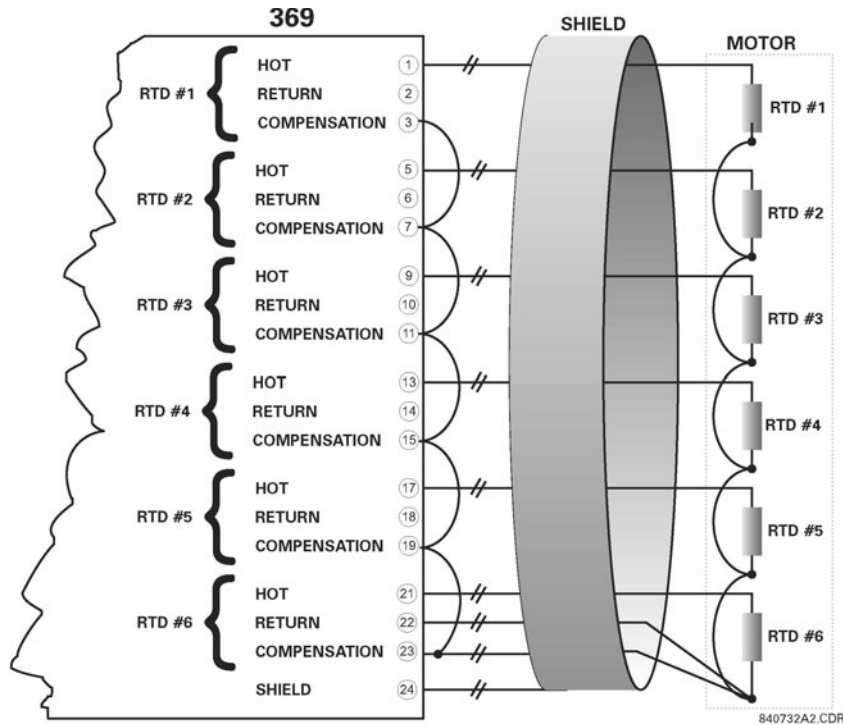

FIGURE 7-14: Reduced Wiring RTDs

The Hot line for each RTD is run as usual for each RTD. However, the Compensation and Return leads need only be run for the first RTD. At the motor RTD terminal box, connect the RTD Return leads together with as short as possible jumpers. At the 369 relay, the Compensation leads must be jumpered together.

Note that an error is produced on each RTD equal to the voltage drop across the RTD return jumper. This error increases for each successive RTD added as:

$$V_{RTD1} = V_{RTD1}$$

$$V_{RTD2} = V_{RTD2} + V_{J3}$$

$$V_{RTD3} = V_{RTD3} + V_{J3} + V_{J4}$$

$$V_{RTD4} = V_{RTD4} + V_{J3} + V_{J4} + V_{J5}, \text{ etc....}$$

This error is directly dependent on the length and gauge of the jumper wires and any error introduced by a poor connection. For RTD types other than 10C, the error introduced by the jumpers is negligible.

Although this RTD wiring technique reduces the cost of wiring, the following disadvantages must be noted:

1. There is an error in temperature readings due to lead and connection resistances. **Not** recommended for 10C RTDs.
2. If the RTD Return lead to the 369 or one of the jumpers breaks, all RTDs from the point of the break onwards will read open.
3. If the Compensation lead breaks or one of the jumpers breaks, all RTDs from the point of the break onwards will function without any lead compensation.

### 7.6.11 Two Wire RTD Lead Compensation

An example of how to add lead compensation to a two wire RTD is shown below.

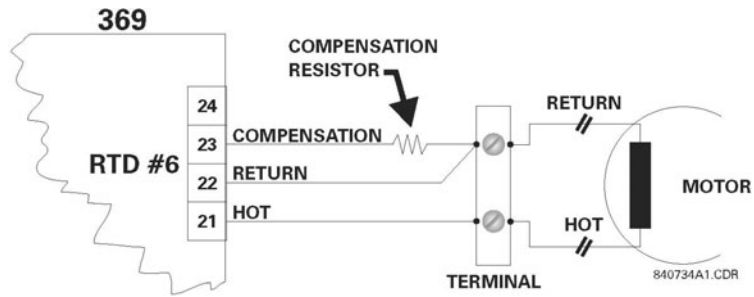

FIGURE 7-15: 2 Wire RTD Lead Compensation

The compensation lead would be added and it would compensate for the Hot and the Return assuming they are all of equal length and gauge. To compensate for resistance of the Hot and Compensation leads, a resistor equal to the resistance of the Hot lead could be added to the compensation lead, though in many cases this is unnecessary.

### 7.6.12 Auto Transformer Starter Wiring

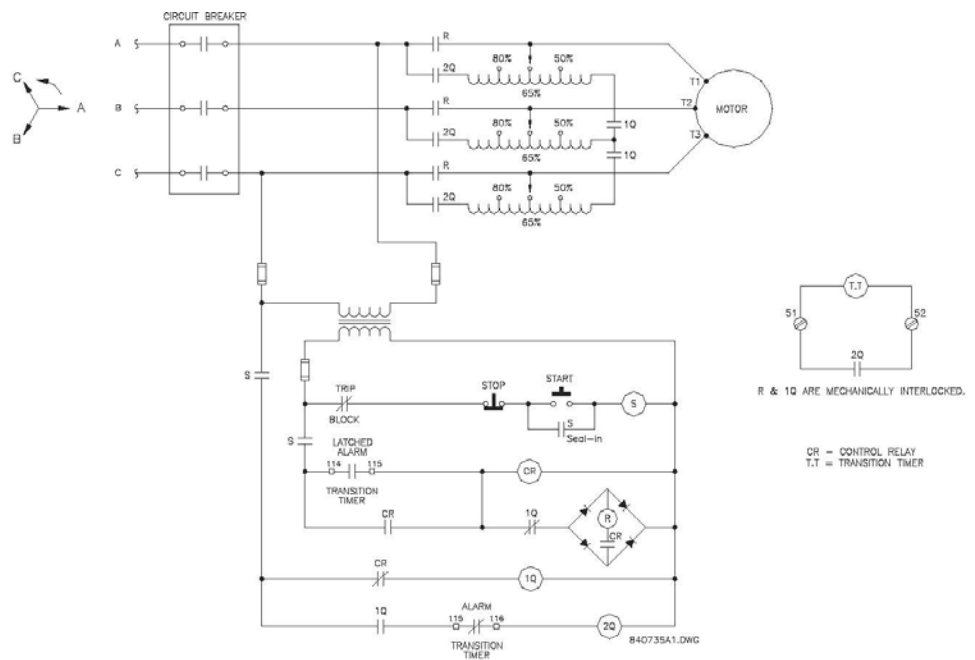

FIGURE 7-16: Auto Transformer, Reduced Voltage Starting Circuit





# 369 Motor Management Relay

## Chapter 8: Testing

---

### 8.1 Test Setup

#### 8.1.1 Introduction

This chapter demonstrates the procedures necessary to perform a complete functional test of all the 369 hardware while also testing firmware/hardware interaction in the process. Testing of the relay during commissioning using a primary injection test set will ensure that CTs and wiring are correct and complete.

8.1.2 Secondary Injection Test Setup

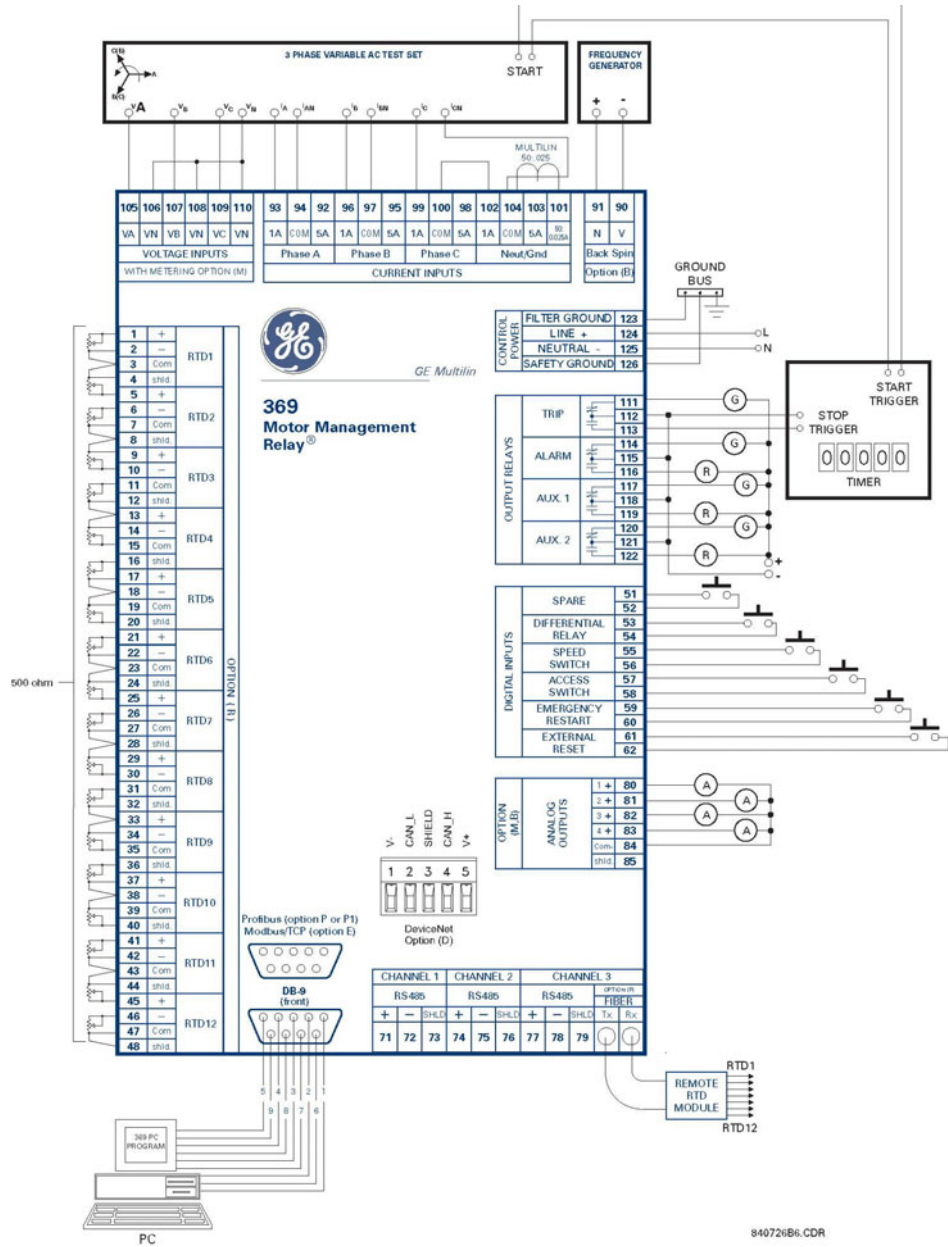

FIGURE 8-1: Secondary Injection Test Setup



## 8.2 Hardware Functional Testing

### 8.2.1 Phase Current Accuracy Test

The 369 specification for phase current accuracy is  $\pm 0.5\%$  of  $2 \times CT$  when the injected current is less than  $2 \times CT$ . Perform the steps below to verify accuracy.

1. Alter the following setpoint:

**S2 SYSTEM SETUP**  $\downarrow$  **CT / VT SETUP**  $\downarrow$  **PHASE CT PRIMARY:** 1000 A

2. Measured values should be within  $\pm 10A$  of expected. Inject the values shown in the table below and verify accuracy of the measured values. View the measured values in:

**A2 METERING DATA**  $\downarrow$  **CURRENT METERING**

INJECTED CURRENT 1 A UNIT	INJECTED CURRENT 5 A UNIT	EXPECTED CURRENT READING	MEASURE D CURRENT PHASE A	MEASURE D CURRENT PHASE B	MEASURE D CURRENT PHASE C
0.1 A	0.5 A	100 A			
0.2 A	1.0 A	200 A			
0.5 A	2.5 A	500 A			
1 A	5 A	1000 A			
1.5 A	7.5 A	1500 A			
2 A	10 A	2000 A			

### 8.2.2 Voltage Input Accuracy Test

The 369 specification for voltage input accuracy is  $\pm 1.0\%$  of full scale (240 V). Perform the steps below to verify accuracy.

1. Alter the following setpoints:

**S2 SYSTEM**  $\downarrow$  **CT/VT SETUP**  $\downarrow$  **VT CONNECTION TYPE:** Wye

**S2 SYSTEM SETUP**  $\downarrow$  **CT/VT SETUP**  $\downarrow$  **VOLTAGE TRANSFORMER RATIO:**  
10

2. Measured values should be within  $\pm 24 V (\pm 1 \times 240 \times 10)$  of expected. Apply the voltage values shown in the table and verify accuracy of the measured values. View the measured values in:

**A2 METERING DATA**  $\downarrow$  **VOLTAGE METERING**

APPLIED LINE- NEUTRAL VOLTAGE	EXPECTED VOLTAGE READING	MEASURED VOLTAGE A- N	MEASURED VOLTAGE B- N	MEASURED VOLTAGE C- N
30 V	300 V			
50 V	500 V			
100 V	1000 V			
150 V	1500 V			
200 V	2000 V			
240 V	2400 V			

### 8.2.3 Ground (1 A / 5 A) Accuracy Test

The 369 specification for the 1 A/5 A ground current input accuracy is  $\pm 0.5\%$  of  $1 \times CT$  for the 5 A input and  $\pm 0.5\%$  of  $5 \times CT$  for the 1 A input. Perform the steps below to verify accuracy.

#### 5A Input:

- Alter the following setpoints:  
**S2 SYSTEM SETUP**  $\downarrow$  **CT/VT SETUP**  $\downarrow$  **GROUND CT TYPE:** 5A Secondary  
**S2 SYSTEM SETUP**  $\downarrow$  **CT/VT SETUP**  $\downarrow$  **GROUND CT PRIMARY:** 1000 A
- Measured values should be  $\pm 5$  A. Inject the values shown in the table below into one phase only and verify accuracy of the measured values. View the measured values in **A2 METERING DATA**  $\downarrow$  **CURRENT METERING**

INJECTED CURRENT 5 A UNIT	EXPECTED CURRENT READING	MEASURED GROUND CURRENT
0.5 A	100 A	
1.0 A	200 A	
2.5 A	500 A	
5 A	1000 A	

#### 1A Input:

- Alter the following setpoints:  
**S2 SYSTEM SETUP**  $\downarrow$  **CT/VT SETUP**  $\downarrow$  **GROUND CT TYPE:** 1A Secondary  
**S2 SYSTEM SETUP**  $\downarrow$  **CT/VT SETUP**  $\downarrow$  **GROUND CT PRIMARY:** 1000 A
- Measured values should be  $\pm 25$  A. Inject the values shown in the table below into one phase only and verify accuracy of the measured values. View the measured values in **A2 METERING DATA**  $\downarrow$  **CURRENT METERING**

INJECTED CURRENT 1 A UNIT	EXPECTED CURRENT READING	MEASURED GROUND CURRENT
0.1 A	100 A	
0.2 A	200 A	
0.5 A	500 A	
1.0 A	1000 A	

### 8.2.4 50:0.025 Ground Accuracy Test

The 369 specification for GE Multilin 50:0.025 ground current input accuracy is  $\pm 0.5\%$  of CT rated primary (25 A). Perform the steps below to verify accuracy.

- Alter the following setpoint:  
**S2 SYSTEM SETUP**  $\downarrow$  **CT/VT SETUP**  $\downarrow$  **GROUND CT TYPE:** MULTILIN  
 50:0.025

- Measured values should be within  $\pm 0.125$  A of expected. Inject the values shown below either as primary values into a GE Multilin 50:0.025 Core Balance CT or as secondary values that simulate the core balance CT. Verify accuracy of the measured values. View the measured values in [A2 METERING DATA](#)  $\downarrow$  [CURRENT METERING](#)

PRIMARY INJECTED CURRENT 50:0.025 CT	SECONDARY INJECTED CURRENT	EXPECTED CURRENT READING	MEASURED GROUND CURRENT
0.25 A	0.125 mA	0.25 A	
1 A	0.5 mA	1.00 A	
10 A	5 mA	10.00 A	
25 A	12.5 mA	25.00 A	

### 8.2.5 RTD Accuracy Test

- The 369 specification for RTD input accuracy is  $\pm 2^\circ$ . Alter the following setpoints:  
**S6 RTD TEMPERATURE**  $\downarrow$  **RTD TYPE**  $\downarrow$  **STATOR RTD TYPE:** “100 ohm Platinum” (select desired type)
- Measured values should be  $\pm 2^\circ\text{C}$  or  $\pm 4^\circ\text{F}$ . Alter the resistances applied to the RTD inputs as per the table below to simulate RTDs and verify accuracy of the measured values. View the measured values in:  
**A2 METERING DATA**  $\downarrow$  **LOCAL RTD** (and/or **REMOTE RTD** if using the RRTD Module)
- Select the preferred temperature units for the display. Alter the following setpoint:  
**S1 369 SETUP**  $\downarrow$  **DISPLAY PREFERENCES**  $\downarrow$  **TEMPERATURE DISPLAY:** “Celsius” (or “Fahrenheit” if preferred)
- Repeat the above measurements for the other RTD types (120 ohm Nickel, 100 ohm Nickel and 10 ohm Copper)

APPLIED RESISTANCE 100 Ohm PLATINUM	EXPECTED RTD TEMPERATURE READING		MEASURED RTD TEMPERATURE ✓ SELECT ONE: ____ (°C) ____ (°F)											
	CELSIUS	FAHRENHEIT	1	2	3	4	5	6	7	8	9	10	11	12
84.27 ohms	-40°C	-40°F												
100.00 ohms	0°C	32°F												
119.39 ohms	50°C	122°F												
138.50 ohms	100°C	212°F												
157.32 ohms	150°C	302°F												
175.84 ohms	200°C	392°F												

APPLIED RESISTANCE 120 Ohm NICKEL	EXPECTED RTD TEMPERATURE READING		MEASURED RTD TEMPERATURE ✓ SELECT ONE: ____ (°C) ____ (°F)											
	CELSIUS	FAHRENHEIT	1	2	3	4	5	6	7	8	9	10	11	12
92.76 ohms	-40°C	-40°F												
120.00 ohms	0°C	32°F												

APPLIED RESISTANCE 120 Ohm NICKEL	EXPECTED RTD TEMPERATURE READING		MEASURED RTD TEMPERATURE ✓ SELECT ONE: ____ (°C) ____ (°F)											
	CELSIUS	FAHRENHEIT	1	2	3	4	5	6	7	8	9	10	11	12
	157.74 ohms	50°C	122°F											
200.64 ohms	100°C	212°F												
248.95 ohms	150°C	302°F												
303.46 ohms	200°C	392°F												

APPLIED RESISTANCE E 100 Ohm NICKEL	EXPECTED RTD TEMPERATURE READING		MEASURED RTD TEMPERATURE ✓ SELECT ONE: ____ (°C) ____ (°F)											
	CELSIUS	FAHRENHEIT	1	2	3	4	5	6	7	8	9	10	11	12
	79.13 ohms	-40°C	-40°F											
100.0 ohms	0°C	32°F												
129.1 ohms	50°C	122°F												
161.8 ohms	100°C	212°F												
198.7 ohms	150°C	302°F												
240.0 ohms	200°C	392°F												

APPLIED RESISTANCE E 10 Ohm COPPER	EXPECTED RTD TEMPERATURE READING		MEASURED RTD TEMPERATURE ✓ SELECT ONE: ____ (°C) ____ (°F)											
	CELSIUS	FAHRENHEIT	1	2	3	4	5	6	7	8	9	10	11	12
	7.49 ohms	-40°C	-40°F											
9.04 ohms	0°C	32°F												
10.97 ohms	50°C	122°F												
12.90 ohms	100°C	212°F												
14.83 ohms	150°C	302°F												
16.78 ohms	200°C	392°F												

### 8.2.6 Digital Inputs

The digital inputs can be verified easily with a simple switch or pushbutton. Perform the steps below to verify functionality of the digital inputs.

1. Open switches of all of the digital inputs.
2. View the status of the digital inputs in **A1 STATUS ▾ DIGITAL INPUT STATUS**
3. Close switches of all of the digital inputs.
4. View the status of the digital inputs in **A1 STATUS ▾ DIGITAL INPUT STATUS**

INPUT	EXPECTED STATUS (SWITCH OPEN)	✓ PASS * FAIL	EXPECTED STATUS (SWITCH CLOSED)	✓ PASS * FAIL
SPARE	Open		Shorted	
DIFFERENTIAL RELAY	Open		Shorted	
SPEED SWITCH	Open		Shorted	

<b>INPUT</b>	<b>EXPECTED STATUS (SWITCH OPEN)</b>	<b>✓ PASS * FAIL</b>	<b>EXPECTED STATUS (SWITCH CLOSED)</b>	<b>✓ PASS * FAIL</b>
ACCESS SWITCH	Open		Shorted	
EMERGENCY RESTART	Open		Shorted	
EXTERNAL RESET	Open		Shorted	

### 8.2.7 Analog Inputs and Outputs

The 369 specification for analog input and analog output accuracy is  $\pm 1\%$  of full scale. Perform the steps below to verify accuracy.

#### 4 to 20mA ANALOG INPUT:

1. Alter the following setpoints:  
**S10 ANALOG OUTPUTS**  $\downarrow$  **ANALOG OUTPUT 1**  $\downarrow$  **ANALOG RANGE:** 4-20 mA (repeat for analog inputs 2 to 4)
2. Analog output values should be  $\pm 0.2$  mA on the ammeter. Force the analog outputs using the following setpoints:  
**S11 TESTING**  $\downarrow$  **TEST ANALOG OUTPUTS**  $\downarrow$  **FORCE ANALOG OUTPUT 1:** 0% (enter desired percent, repeat for analog outputs 2 to 4)
3. Verify the ammeter readings for all the analog outputs
4. Repeat 1 to 3 for the other forced output settings

ANALOG OUTPUT FORCE VALUE	EXPECTED AMMETER READING	MEASURED AMMETER READING (mA)			
		1	2	3	4
0	4 mA				
25	8 mA				
50	12 mA				
75	16 mA				
100	20 mA				

#### 0 to 1mA Analog Input:

1. Alter the following setpoints:  
**S10 ANALOG OUTPUTS**  $\downarrow$  **ANALOG OUTPUT 1**  $\downarrow$  **ANALOG RANGE:** “0-1 mA” (repeat for analog inputs 2 to 4)
2. Analog output values should be  $\pm 0.01$  mA on the ammeter. Force the analog outputs using the following setpoints:  
**S11 TESTING**  $\downarrow$  **TEST ANALOG OUTPUTS**  $\downarrow$  **FORCE ANALOG OUTPUT 1:** “0%” (enter desired percent, repeat for analog outputs 2 to 4)
3. Verify the ammeter readings for all the analog outputs
4. Repeat 1 to 3 for the other forced output settings.

ANALOG OUTPUT FORCE VALUE	EXPECTED AMMETER READING	MEASURED AMMETER READING (mA)			
		1	2	3	4
0	0 mA				
25	0.25 mA				
50	0.5 mA				
75	0.75 mA				
100	1.0 mA				

### 0 to 20mA Analog Input:

- Alter the following setpoints:  
**S10 ANALOG OUTPUTS** ↓ **ANALOG OUTPUT 1** ↓ **ANALOG RANGE:** “0-20 mA” (repeat for analog inputs 2 to 4)
- Analog output values should be  $\pm 0.2$  mA on the ammeter. Force the analog outputs using the following setpoints:  
**S11 TESTING** ↓ **TEST ANALOG OUTPUTS** ↓ **FORCE ANALOG OUTPUT 1:** “0%”  
 (enter desired percent, repeat for analog outputs 2 to 4)
- Verify the ammeter readings for all the analog outputs
- Repeat steps 1 to 3 for the other forced output settings.

ANALOG OUTPUT FORCE VALUE	EXPECTED AMMETER READING	MEASURED AMMETER READING (mA)			
		1	2	3	4
0	0 mA				
25	5 mA				
50	10 mA				
75	15 mA				
100	20 mA				

### 8.2.8 Output Relays

To verify the functionality of the output relays, perform the following steps:

- Use the following setpoints:  
**S11 TESTING** ↓ **TEST OUTPUT RELAYS** ↓ **FORCE TRIP RELAY:** “Energized”  
**S11 TESTING** ↓ **TEST OUTPUT RELAYS** ↓ **FORCE TRIP RELAY DURATION:** “Static”
- Using the above setpoints, individually select each of the other output relays (AUX 1, AUX 2 and ALARM) and verify operation.

FORCE OPERATIO N SETPOINT	EXPECTED MEASUREMENT (✓ for SHORT)								ACTUAL MEASUREMENT (✓ for SHORT)							
	R1		R2		R3		R4		R1		R2		R3		R4	
	no	nc	no	nc	no	nc	no	nc	no	nc	no	nc	no	nc	no	nc
R1 Trip	✓			✓		✓		✓								
R2 Auxiliary		✓	✓			✓		✓								
R3 Auxiliary		✓		✓	✓			✓								
R4 Alarm		✓		✓		✓	✓									

## 8.3 Additional Functional Testing

### 8.3.1 Overload Curve Test

The 369 specification for overload curve timing accuracy is  $\pm 100$  ms or  $\pm 2\%$  of time to trip. Pickup accuracy is as per current inputs ( $\pm 0.5\%$  of  $2 \times CT$  when the injected current is  $< 2 \times CT$ ;  $\pm 1\%$  of  $20 \times CT$  when the injected current is  $\geq 2 \times CT$ ).

- Perform the steps below to verify accuracy. Alter the following setpoints:

  - S2 SYSTEM SETUP**  $\downarrow$  **CT/VT SETUP**  $\downarrow$  **PHASE CT PRIMARY:** “1000”
  - S2 SYSTEM SETUP**  $\downarrow$  **CT/VT SETUP**  $\downarrow$  **MOTOR FULL LOAD AMPS FLA:** “1000”
  - S3 OVERLOAD PROTECTION**  $\downarrow$  **OVERLOAD CURVES**  $\downarrow$  **SELECT CURVE STYLE:** “Standard”
  - S3 OVERLOAD PROTECTION**  $\downarrow$  **OVERLOAD CURVES**  $\downarrow$  **STANDARD OVELOAD CURVE NUMBER:** “4”
  - S3 OVERLOAD PROTECTION**  $\downarrow$  **THERMAL MODEL**  $\downarrow$  **OVERLOAD PICKUP LEVEL:** “1.10”
  - S3 OVERLOAD PROTECTION**  $\downarrow$  **THERMAL MODEL**  $\downarrow$  **UNBALANCE BIAS K FACTOR:** “0”
  - S3 OVERLOAD PROTECTION**  $\downarrow$  **THERMAL MODEL**  $\downarrow$  **HOT/COLD SAFE STALL RATIO:** “1.00”
  - S3 OVERLOAD PROTECTION**  $\downarrow$  **THERMAL MODEL**  $\downarrow$  **ENABLE RTD BIASING:** “No”
- Any trip must be reset prior to each test. Short the emergency restart terminals momentarily immediately prior to each overload curve test to ensure that the thermal capacity used is zero. Failure to do so will result in shorter trip times. Inject the current of the proper amplitude to obtain the values as shown and verify the trip times. Motor load may be viewed in **A2 METERING DATA**  $\downarrow$  **CURRENT METERING**

Thermal capacity used and estimated time to trip may be viewed in **A1 STATUS**  $\downarrow$  **MOTOR STATUS**

AVERAGE PHASE CURRENT DISPLAYED	INJECTED CURRENT 1 A UNIT	PICKUP LEVEL	EXPECTED TIME TO TRIP	TOLERANCE RANGE	MEASURED TIME TO TRIP
1050 A	1.05 A	1.05	never	N/A	
1200 A	1.20 A	1.20	795.44 s	779.53 to 811.35 s	
1750 A	1.75 A	1.75	169.66 s	166.27 to 173.05 s	
3000 A	3.0 A	3.00	43.73 s	42.86 to 44.60 s	
6000 A	6.0 A	6.00	9.99 s	9.79 to 10.19 s	
10000 A	10.0 A	10.00	5.55 s	5.44 to 5.66 s	



### 8.3.2 Power Measurement Test

The 369 specification for reactive and apparent power is  $\pm 1.5\%$  of  $2 \times CT \times VT$  full scale at  $I_{avg} < 2 \times CT$ . Perform the steps below to verify accuracy.

- Alter the following setpoints:
  - S2 SYSTEM SETUP**  $\downarrow$  **CT/VT SETUP**  $\downarrow$  **PHASE CT PRIMARY:** “1000”
  - S2 SYSTEM SETUP**  $\downarrow$  **CT/VT SETUP**  $\downarrow$  **VT CONNECTION TYPE:** “Wye”
  - S2 SYSTEM SETUP**  $\downarrow$  **CT/VT SETUP**  $\downarrow$  **VT RATIO:** “10.00:1”
- Inject current and apply voltage as per the table below. Verify accuracy of the measured values. View the measured values in **A2 METERING DATA**  $\downarrow$  **POWER METERING**

INJECTED CURRENT / APPLIED VOLTAGE (Ia is reference vector)		POWER QUANTITY			POWER FACTOR	
1 A UNIT	5 A UNIT	EXPECTED	TOLERANCE RANGE	MEASURED	EXPECTED	MEASURED
Ia = 1 A $\angle 0^\circ$ Ib = 1 A $\angle 120^\circ$ Ic = 1 A $\angle 240^\circ$ Va = 120 V $\angle 342^\circ$ Vb = 120 V $\angle 102^\circ$ Vc = 120 V $\angle 222^\circ$	Ia = 5 A $\angle 0^\circ$ Ib = 5 A $\angle 120^\circ$ Ic = 5 A $\angle 240^\circ$ Va = 120 V $\angle 342^\circ$ Vb = 120 V $\angle 102^\circ$ Vc = 120 V $\angle 222^\circ$	+3424 kW	3352 to 3496 kW		0.95 lag	
Ia = 1 A $\angle 0^\circ$ Ib = 1 A $\angle 120^\circ$ Ic = 1 A $\angle 240^\circ$ Va = 120 V $\angle 288^\circ$ Vb = 120 V $\angle 48^\circ$ Vc = 120 V $\angle 168^\circ$	Ia = 5 A $\angle 0^\circ$ Ib = 5 A $\angle 120^\circ$ Ic = 5 A $\angle 240^\circ$ Va = 120 V $\angle 288^\circ$ Vb = 120 V $\angle 48^\circ$ Vc = 120 V $\angle 168^\circ$	+3424 kvar	3352 to 3496 kvar		0.31 lag	

### 8.3.3 Voltage Phase Reversal Test

The 369 can detect voltage phase rotation and protect against phase reversal. To test the phase reversal element, perform the following steps:

- Alter the following setpoints:
  - S2 SYSTEM SETUP**  $\downarrow$  **CT/VT SETUP**  $\downarrow$  **VT CONNECTION TYPE:** “Wye” or “Open Delta”
  - S7 VOLTAGE ELEMENTS**  $\downarrow$  **PHASE REVERSAL**  $\downarrow$  **PHASE REVERSAL TRIP:** “On”
  - S7 VOLTAGE ELEMENTS**  $\downarrow$  **PHASE REVERSAL**  $\downarrow$  **ASSIGN TRIP RELAYS:** “Trip”
  - S2 SYSTEM SETUP**  $\downarrow$  **CT/VT SETUP**  $\downarrow$  **SYSTEM PHASE SEQUENCE:** “ABC”
- Apply voltages as per the table below. Verify the 369 operation on voltage phase reversal.

APPLIED VOLTAGE	EXPECTED RESULT * NO TRIP ✓ PHASE REVERSAL TRIP	OBSERVED RESULT * NO TRIP ✓ PHASE REVERSAL TRIP
Va = 120 V $\angle 0^\circ$ Vb = 120 V $\angle 120^\circ$ Vc = 120 V $\angle 240^\circ$	*	

APPLIED VOLTAGE	EXPECTED RESULT * NO TRIP ✓ PHASE REVERSAL TRIP	OBSERVED RESULT * NO TRIP ✓ PHASE REVERSAL TRIP
Va = 120 V∠0° Vb = 120 V∠240° Vc = 120 V∠120°	✓	

### 8.3.4 Short Circuit Test

The 369 specification for short circuit timing is +40 ms or  $\pm 0.5\%$  of total time. The pickup accuracy is as per the phase current inputs. Perform the steps below to verify the performance of the short circuit element.

1. Alter the following setpoints:

**S2 SYSTEM SETUP** ↓ **CT/VT SETUP** ↓ **PHASE CT PRIMARY:** “1000”

**S4 CURRENT ELEMENTS** ↓ **SHORT CIRCUIT** ↓ **SHORT CIRCUIT TRIP:** “On”

**S4 CURRENT ELEMENTS** ↓ **SHORT CIRCUIT** ↓ **ASSIGN TRIP RELAYS:** “Trip”

**S4 CURRENT ELEMENTS** ↓ **SHORT CIRCUIT** ↓ **SHORT CIRCUIT PICKUP LEVEL:** “5.0 x CT”

**S4 CURRENT ELEMENTS** ↓ **SHORT CIRCUIT** ↓ **ADD S/C DELAY:** “0”

2. Inject current as per the table below, resetting the unit after each trip by pressing the [RESET] key, and verify timing accuracy. Pre-trip values may be viewed in

**A1 STATUS** ↓ **LAST TRIP DATA**

INJECTED CURRENT		TIME TO TRIP (ms)	
5 A UNIT	1 A UNIT	EXPECTED	MEASURED
30 A	6 A	< 40 ms	
40 A	8 A	< 40 ms	
50 A	10 A	< 40 ms	





# 369 Motor Management Relay

## Appendix: Revisions

### A.1 Change Notes

#### A.1.1 Revision History

Table A-1: Revision History

MANUAL P/N	369 REVISION	RELEASE DATE
1601-0077-B1	53CMB105.000	07 May 1999
1601-0077-B2	53CMB110.000	08 June 1999
1601-0077-B3	53CMB110.000	15 June 1999
1601-0077-B4	53CMB110.000	04 August 1999
1601-0077-B5	53CMB120.000	15 October 1999
1601-0077-B6	53CMB130.000	03 January 2000
1601-0077-B7	53CMB142.000	03 April 2000
1601-0777-B8	53CMB145.000	14 June 2000
1601-0777-B9	53CMB160.000	12 October 2000
1601-0777-BA	53CMB161.000	19 October 2000
1601-0077-BB	53CMB17x.000	09 February 2001
1601-0077-BC	53CMB18x.000	15 June 2001
1601-0077-BD	53CMB19x.000	01 August 2002
1601-0077-BE	53CMB20x.000	01 March 2004
1601-0077-BF	53CMB21x.000	05 November 2004
1601-0077-BG	53CMB22x.000	11 April 2005
1601-0077-BH	53CMB23x.000	19 September 2005
1601-0077-BJ	53CMB24x.000	21 November 2005

Table A-1: Revision History

MANUAL P/N	369 REVISION	RELEASE DATE
1601-0077-BK	53CMB25x.000	May 15, 2006
1601-0077-BL	53CMC310.000	June 7, 2007
1601-0077-BM	53CMC320.000	February 29, 2008
1601-0077-BN	53CMC320.000	June 6, 2008
1601-0077-BP	53CMC320.000	August 8, 2008
1601-0077-BR	53CMC320.000	October 17, 2008
1601-0077-BS	53CMC330.000	March 6, 2009
1601-0077-BT	53CMC330.000	March 23, 2010
1601-0077-BU	53CMC340.000	June 23, 2010

Table A-2: Major Updates for 369-BU

SECTION	CHANGES
	New manual revision number: BU
5.2.3	Fieldbus Loss of Communications added

Table A-3: Major Updates for 369-BT

SECTION	CHANGES
	New manual revision number: BT
Index	Index corrected and updated

Table A-4: Major Updates for 369-BS

SECTION	CHANGES
	New manual revision number: BS
2.2.4	Fieldbus Loss of Comms section added

Table A-5: Major Updates for 369-BR

SECTION	CHANGES
	New manual revision number: BR
5.2.3	Note added, re cycling power supply.
7.2.1 (FAQ)	Q/A added, re cycling of power supply.

Table A-6: Major Updates for 369-BP

SECTION	CHANGES
	New manual revision number: BP
5.7.2/5.10.1	Note added, re editing of RTD name and General Switch Name via EnerVista only.

Table A-7: Major Updates for 369-BN

SECTION	CHANGES
	New manual revision number: BN
2.2.8/2.2.11	Add T-Code rating to Specifications/Type Tests.
2.2.10	Add new UL file number to UL Listings.
2.2.2	Update Hazardous Location note.
3.3.3	Add Reboot Time information.

Table A-8: Major Updates for 369-BM

SECTION	CHANGES
	New manual revision number: BM
Chapter 9	Chapter 9 - Communications - removed and a separate Communications Guide created from it.
Chapters 2, 3, 5, 6	2-speed motor feature added
Chapters 5, 6, Comm Guide	Datalogger feature added
Chapter 3	New Forward/Reverse wiring diagram added
Chapter 2	Update Control Power specs.
5.3.5	Latched trip and alarm note added
6.6.1	Motor Speed and Hottest Stator display information added/changed
4.6.4	Motor Start Data Logger changes
4.6.5	Motor Health Report changes
5.2.3	Profibus Loss of Communication display change
5.7.4	Phase Reversal info changes, new diagram added
6.3.9	Phasor information changes
Chapter 5	MMI Display hiding changes
5.7.4	Phase Reversal description changes
6.2.2	Speed of Last Trip MMI display added

Table A-9: Major Updates for 369-BL

CHANGES
Added new UL and CSA information
Deleted MOD 502 hazardous location option
Fig. 3.3.10 - Clarified that resistance is per-lead, and not total resistance
Firmware revision to 3.10
Increase number of event records from 250 to 512
New feature added: Undervoltage Autorestart
New feature added: Motor Start Data Logger
New feature added: Enhanced Motor Learned Data
New feature added: Detect If 369 Is Communicating With RRTDs
New feature added: New Order Code Item For "MMI Display Style"
New feature added: DeviceNet Poll Data Groups

Table A-10: Major Updates for 369-BK

CHANGES
Added new START CONTROL RELAY TIMER setpoint under the Reduced Voltage Starting menu
Added new Modbus register for "Starts Per Hour Lockout Time" at address 0x02CA
Section 5.10.5: SPEED SWITCH modified to reflect the correct front panel display order
Table in section 8.2.3 updated to reflect correct ground fault CT range
Broadcast date and time in Modbus address corrected (0x00F0 and 0x00F2)
DeviceNet Assembly object, class code 04h, instance 68h, attribute 03 access type corrected to "GET"
Added ODVA DeviceNet CONFORMANCE TESTED™ certification to technical specifications
Updated section 2.2.10: TYPE TEST STANDARDS to reflect updates to IEC and EN test numbers

Table A-11: Major Updates for 369-BJ

CHANGES
Updated custom curve ranges from "0 to 32767 s" to "0 to 65534 s"

Table A-12: Major Updates for 369-BH

CHANGES
Updated manual for the Profibus-DPV1 option
Added BLOCK PROTECTION FUNCTIONS and FORCE OUTPUT RELAYS sections
Added communications sections of Chapter 9



Table A-13: Major Updates for 369-BG

CHANGES
Updated the 369 order code for the Harsh Environment option
Added setpoints for DeviceNet communications and Starter Operation Monitor
Added DeviceNet communications section to Chapter 9

Table A-14: Major Updates for 369-BF

CHANGES
Changes made to Modbus/TCP interface
Additions for variable frequency functionality

Table A-15: Major Updates for 369-BE

CHANGES
Added <b>MOTOR LOAD AVERAGING INTERVAL</b> setpoint to the Thermal Model feature.
Added starter failure and energy metering to analog output parameters

Table A-16: Major Updates for 369-BD

CHANGES
Added <b>DEFAULT TO HOTTEST STATOR RTD TEMP</b> setpoint to default messages.
Updated Section 5.3.7: AUTORESTART and Figure 5-5: AUTORESTART LOGIC.
Updated EVENT RECORDER section to reflect 250 events
Added EVENT RECORDS setpoints to S1 369 SETUP section.
Added Filter/Safety Ground question to Section 7.2.1: FREQUENTLY ASKED QUESTIONS.
Updated MEMORY MAP and MEMORY MAP FORMATS tables.

Table A-17: Major Updates for 369-BC

CHANGES
Updated ORDERING TABLE to reflect Modbus/TCP option
Updated Figure 1-1: FRONT AND REAR VIEW to 840702BF
Updated Figure 3-4: TYPICAL WIRING
Added new Modbus/TCP setpoints and description in Section 5.2.4: COMMUNICATIONS
Updated Figures 5-3 and 5-4, REDUCED VOLTAGE STARTER AUXILIARY INPUTS
Updated Section 7.2.4: CT SELECTION to fix errors in the application example
Updated Figure 8-1: SECONDARY INJECTION TEST SETUP
Updated Table 9-1: SETPOINTS TABLE to include new Modbus/TCP setpoints
Updated MEMORY MAP and MEMORY MAP FORMATS to include new Modbus/TCP setpoints

Table A-18: Major Updates for 369-BB

CHANGES
Updated Figure 1-1: FRONT AND REAR VIEW
Corrected errors in Table 3-1: TERMINAL LIST
Updated Figure 3-4: TYPICAL WIRING
Removed SINGLE VT WYE/DELTA connection diagram in Chapter 3 (feature no longer supported)
Removed <b>ENABLE SINGLE VT OPERATION</b> setpoint from Section 5.3.2: CT/VT SETUP (feature no longer supported)
Added new Section 5.3.7: AUTORESTART

Table A-19: Major Updates for 369-BA

CHANGES
There were no changes to the content of the manual for this release.

Table A-20: Major Updates for 369-B9

CHANGES
Updated Figure 3-4: TYPICAL WIRING
Updated Figure 3-15: REMOTE RTD MODULE
Added menu item <b>PROFIBUS ADDRESS</b> to the 369 Setup Communications menu
Added menu item <b>CLEAR ENERGY DATA</b> to the 369 Setup Clear/Preset Data menu
Added Section 10.2: PROFIBUS PROTOCOL to Communications chapter

Table A-21: Major Updates for 369-B8

CHANGES
Firmware version 53CMB145.000 contains only minor software changes that do not affect the functionality of the 369 or the 1601-0777-B8 manual contents.

---

## A.2 Warranty

### A.2.1 Warranty Information

#### **GE MULTILIN RELAY WARRANTY**

General Electric Multilin (GE Multilin) warrants each relay it manufactures to be free from defects in material and workmanship under normal use and service for a period of 24 months from date of shipment from factory.

In the event of a failure covered by warranty, GE Multilin will undertake to repair or replace the relay providing the warrantor determined that it is defective and it is returned with all transportation charges prepaid to an authorized service centre or the factory. Repairs or replacement under warranty will be made without charge.

Warranty shall not apply to any relay which has been subject to misuse, negligence, accident, incorrect installation or use not in accordance with instructions nor any unit that has been altered outside a GE Multilin authorized factory outlet.

GE Multilin is not liable for special, indirect or consequential damages or for loss of profit or for expenses sustained as a result of a relay malfunction, incorrect application or adjustment.

For complete text of Warranty (including limitations and disclaimers), refer to GE Multilin Standard Conditions of Sale.





# 369 Motor Management Relay

## Index

---

### Numerics

2 PHASE CT CONFIGURATION .....	7-248
269-369 CONVERSION TERMINAL LIST .....	3-31
369	
pc interface .....	4-60
5A	
ground CT installation.....	3-55
input .....	8-258
86 LOCKOUT SWITCH .....	7-229

---

### A

A1 STATUS .....	6-202
A2 METERING DATA .....	6-207
A3 LEARNED DATA .....	6-213
A4 STATISTICAL DATA .....	6-216
A5 EVENT RECORD .....	6-219
A6 RELAY INFORMATION .....	6-220
ACCELERATION TRIP .....	5-161, 7-237
ACCESS SECURITY .....	5-111
ACCESS SWITCH .....	5-187
ACCESSORIES .....	1-3
ACTUAL VALUES .....	6-199
main menu .....	6-199
overview .....	6-199
page 6 menu .....	6-220
ADDITIONAL FEATURES .....	2-12
ADDITIONAL FUNCTIONAL TING .....	8-264
ALARM RELAY	
setpoints .....	5-130
ALARM STATUS .....	6-203
ANALOG	
inputs and outputs .....	8-262
outputs .....	3-42, 3-43, 5-190
outputs (Option M).....	2-15
APPROVALS / CERTIFICATION .....	2-24
AUTO TRANSFORMER STARTER WIRING .....	7-253
AUTORESTART .....	5-134, 5-136, 5-137
AUX 1 RELAY	

see AUXILIARY RELAYS	
AUX 2 RELAY	
see AUXILIARY RELAYS	
AUXILIARY RELAYS	
setpoints .....	5-130

---

## B

BACK PORTS (3) .....	2-17
BACKSPIN	
detection .....	5-163
voltage inputs .....	3-41
BEARING RTDS .....	7-238
BSD INPUTS (OPTION B) .....	2-15

---

## C

CLEAR/PRESET DATA .....	5-120
COMMUNICATIONS .....	2-17
control .....	5-132
Modbus/TCP .....	5-113
RS232 .....	4-63, 4-65
RS485 .....	4-63, 4-65
CONTROL	
functions .....	5-131
power .....	3-38, 3-44
COOL TIME CONSTANTS .....	7-240
CORE BALANCE CONNECTION .....	7-224
CT	
burden .....	7-231
circuit .....	7-232
ground CT primary .....	5-122
phase CT primary .....	5-122
secondary resistance .....	7-231
selection .....	7-231
setpoints .....	5-122
size and saturation .....	7-230
withstand .....	7-230
CT AND VT	
polarity .....	7-227
CT/VT SETUP .....	5-122
CURRENT	
metering .....	6-207
unbalance .....	5-158
CURRENT DEMAND .....	5-126, 5-127
CURRENT TRANSFORMER	
see CT	
CUSTOM OVERLOAD CURVE .....	5-148

---

## D

DATE .....	5-115
DEFAULT MESSAGES	
cycle time .....	5-111
setpoints .....	5-119
timeout .....	5-111
DEMAND	
calculation .....	5-127
metering .....	6-210
setpoints .....	5-126, 5-127
DEVICENET	

settings .....	5-113
specifications .....	2-17
DIAGNOSTIC MESSAGES .....	6-203
DIELECTRIC STRENGTH .....	2-24
DIFFERENTIAL SWITCH .....	5-187
Digital .....	8-260
DIGITAL COUNTER .....	5-185
DIGITAL INPUT .....	7-229
status .....	6-204
DIGITAL INPUT FUNCTION	
digital counter .....	5-185
general switch .....	5-184
waveform capture .....	5-185
DISPLAY .....	4-57
preferences .....	5-111
DO'S AND DON'TS .....	7-227
DUST/MOISTURE .....	2-22, 2-25

---

## E

ELECTRICAL INSTALLATION .....	3-37
EMERGENCY RESTART .....	5-187
EMI .....	2-25
ENABLE	
start inhibit .....	7-237
ENERVISTA VIEWPOINT WITH THE 369 .....	4-102
ENVIRONMENTAL SPECIFICATIONS .....	2-22
ENVIRONMENT .....	2-25
ETHERNET	
specifications .....	2-17

---

## F

FACEPLATE	
interface .....	4-57
FACTORY DATA .....	5-121
FAQ .....	7-223
FAST TRANSIENTS .....	2-25
FIBER OPTIC PORT (OPTION F) .....	2-17
FIRMWARE	
history .....	1-3
upgrading via EnerVista 369 setup software .....	4-84
version .....	6-220
FLA .....	5-123
FLASH MESSAGES	
duration .....	5-111
FORCE OUTPUT RELAYS	
settings .....	5-139
FREQUENCY .....	5-124
FREQUENTLY ASKED QUESTIONS .....	7-223
FRONT PORT .....	2-17
communicating .....	7-223
FULL LOAD AMPS .....	5-123

---

## G

GATEWAY ADDRESS .....	5-113
GENERAL SWITCH .....	5-184
GROUND	
(1A/5A) ACCURACY TEST .....	8-258
accuracy test .....	8-258

bus .....	7-227
CT .....	5-123, 7-234
current input .....	3-39
fault .....	5-159, 7-237
fault detection	
ungrounded systems .....	7-250
filter .....	7-227
safety .....	7-227
GUIDEFORM SPECIFICATIONS .....	2-9

---

## H

HARDWARE FUNCTIONAL TESTING .....	8-257
HGF GROUND CT INSTALLATION	
3" and 5" window .....	3-56
8" window .....	3-56
HOT/COLD CURVE RATIO .....	5-151, 7-235
HOT/COLD SAFE STALL RATIO .....	5-143
HUMIDITY .....	2-25

---

## I

IED SETUP .....	4-60
IMPULSE TEST .....	2-24
INPUTS .....	2-13
INSTALLATION .....	3-27
electrical .....	3-37
mechanical .....	3-27
upgrade .....	4-60
INSULATION RESISTANCE .....	2-25
INTRODUCTION AND ORDERING .....	1-1
IP ADDRESS .....	5-113

---

## K

KEYPAD .....	4-58
--------------	------

---

## L

LAG POWER FACTOR .....	5-179
LAST TRIP DATA .....	6-202
LEAD POWER FACTOR .....	5-178
LEARNED START CAPACITY .....	7-247
LOCAL / REMOTE RTD OPERATION .....	5-167
LOCAL RTD .....	6-209
maximums .....	6-214
protection .....	5-165
LONG-TERM STORAGE .....	2-24

---

## M

MECHANICAL INSTALLATION .....	3-27
MECHANICAL JAM .....	5-156, 7-236
MESSAGE SCRATCHPAD .....	5-118
METERED QUANTITIES .....	2-10
METERING .....	2-16
MODBUS	
serial communications control .....	5-132
setpoints .....	5-112, 5-114



MODBUS/TCP COMMUNICATIONS .....	5-113
MODEL INFORMATION .....	6-220
MODIFY OPTIONS .....	5-121
MONITORING SETUP .....	5-125
MOTOR	
cooling .....	5-151
data .....	6-213
FLA .....	5-123
FLC .....	7-234
rated voltage .....	5-122
statistics .....	6-217
status .....	6-202, 6-204
status detection .....	7-239
thermal limits .....	7-234
MOTOR FLA .....	5-123
MPM-369	
conversion terminal list .....	3-35
MTM-369	
conversion terminal list .....	3-34

---

## N

NEGATIVE REACTIVE POWER .....	5-180
NOMINAL FREQUENCY .....	5-124

---

## O

OPEN RTD ALARM .....	5-169
OPERATION .....	5-131
OPTIONS, MODIFYING .....	5-121
ORDERING .....	1-2
OUTPUT RELAYS .....	2-15, 3-44, 8-263
forcing .....	5-139
setpoints .....	5-129, 5-130
OUTPUTS .....	2-15
OVERFREQUENCY .....	5-176
OVERLOAD	
alarm .....	5-154
curve .....	7-236
curve test .....	8-264
pickup .....	7-235
OVERLOAD CURVES	
custom .....	5-148
setpoints .....	5-144, 5-145, 5-196
standard .....	5-145, 5-146, 5-147
OVERLOAD/STALL/THERMAL MODEL .....	2-18
OVERVOLTAGE .....	5-172

---

## P

PARITY .....	5-112
PASSWORDS	
comm password .....	5-111
PC PROGRAM	
software history .....	1-4
PC SOFTWARE	
obtaining .....	7-223
PHASE	
CT .....	5-122, 7-234
CT installation .....	3-54
current (CT) inputs .....	3-38

current accuracy test .....	8-257
line voltage input, VT (Option M) .....	2-14
reversal .....	5-173
voltage (VT/PT) inputs .....	3-40
VT .....	5-123
PHASE SEQUENCY .....	5-124
PHASORS .....	6-211
POLARITY	
CT and VT .....	7-227
POSITIVE REACTIVE POWER .....	5-179
POWER	
measurement test .....	8-265
metering .....	6-208
metering (option m) .....	2-16
POWER DEMAND .....	5-127
PRODUCTION TESTS .....	2-25
PROFIBUS	
setpoints .....	5-114
PROFIBUS ADDRESS .....	5-113
PROFIBUS PORT (OPTION P) .....	2-17
PROGRAMMING EXAMPLE .....	7-233
PROTECTION ELEMENTS .....	2-18

---

## R

REAL TIME CLOCK .....	6-206
setpoints .....	5-115
REDUCED RTD LEAD NUMBER .....	7-251
REDUCED VOLTAGE START .....	5-132, 5-134
RELAY LABEL DEFINITION .....	1-8
REMOTE RESET .....	5-189
REMOTE RTD .....	6-209
address .....	5-112
maximums .....	6-215
module electrical installation .....	3-53
module mechanical installation .....	3-51
protection .....	5-166
RESET .....	5-130
RESIDUAL GROUND FAULT CONNECTION .....	7-224
REVERSE POWER .....	5-183
REVISION HISTORY .....	A-269
RFI .....	2-25
ROLLING DEMAND WINDOW .....	5-127
RRTD ADDRESS .....	5-112
RS232	
communicating .....	7-223
program port .....	4-58
setpoints .....	5-112
RS232 COMMUNICATIONS	
configuring with EnerVista 369 Setup .....	4-63
configuring with EnerVista 369 setup .....	4-65
RS485	
4 wire .....	7-223
cable .....	7-228
communication difficulties .....	7-223
communications .....	3-45
communications port .....	7-228
converter .....	7-228
distances .....	7-228
full duplex .....	7-223
interfacing master device .....	7-228
repeater .....	7-228
setpoints .....	5-112

RS485 COMMUNICATIONS	
configuring with EnerVista 369 setup	4-63, 4-65
RTD	3-42, 7-227
2 wire lead compensation	7-253
accuracy test	8-259
bias	5-143, 5-152, 5-153
bias maximum	7-236
bias mid point	7-236
bias minimum	7-236
circuitry	7-251
grounding	7-229
inputs	3-42
inputs (Option r)	2-15
stator	7-237
RUNNING COOL TIME	7-235

---

## S

S10 ANALOG OUTPUTS	5-190
S11 369 TESTING	5-192
S2 SYSTEM SETUP	5-122
S3 OVERLOAD PROTECTION	5-141
S4 CURRENT ELEMENTS	5-155
S5 MOTOR START / INHIBITS	5-161
S6 RTD TEMPERATURE	5-165
S7 VOLTAGE ELEMENTS	5-171
S8 POWER ELEMENTS	5-177
S9 DIGITAL INPUTS	5-184
SECONDARY INJECTION TEST SETUP	8-256
SECURITY	5-111
SELF-TEST MODE	5-129
SELF-TEST RELAY	5-129
SERIAL COMMUNICATION CONTROL	5-132
SETPOINTS	5-107
access	5-111
entering with EnerVista 369 Setup software	4-69
entry	4-59
loading from a file	4-83
main menu	5-107
page 1 menu	5-111
saving to a file	4-84
SHORT CIRCUIT	5-155
test	8-267
trip	7-236
SHORT/LOW TEMP RTD ALARM	5-169
SOFTWARE	
entering setpoints	4-69
installation	4-60
loading setpoints	4-83
saving setpoints	4-84
serial communications	4-63, 4-65
SPARE SWITCH	5-186
SPEED SWITCH	5-188
START INHIBIT	5-162, 7-241, 7-246
enabled	7-247
starter	
status switch	5-133
STARTER FAILURE	5-126
STARTS/HOUR	7-237
STATOR RTDS	7-237
STOPPED COOL TIME	7-236
STOPPED COOL TIME CONSTANT	7-241
SUBNET MASK	5-113

SYSTEM .....	5-124
SYSTEM FREQUENCY .....	5-124

---

## T

TECHNICAL SPECIFICATIONS .....	2-13
TEMPERATURE .....	2-25
TEMPERATURE DISPLAY .....	5-111
TERMINAL	
identification .....	3-29
layout .....	3-36
list .....	3-29
TEST	
burn in .....	2-25
calibration and functionality .....	2-25
dielectric strength .....	2-25
ground accuracy .....	8-258
hardware functional .....	8-257
input accuracy .....	8-257
overload curve .....	8-264
phase current accuracy .....	8-257
power measurement .....	8-265
production .....	2-25
RTD accuracy .....	8-259
secondary injection .....	8-256
setup .....	8-255
short circuit .....	8-267
type test standards .....	2-24
unbalance .....	8-265
voltage	
metering .....	6-207
phase reversal .....	8-265
TESTING	
analog outputs .....	5-193
output relays .....	5-192
setpoints .....	5-192
THERMAL	
capacity calculation .....	7-244
capacity used .....	7-244
limit .....	7-241
limit curves .....	7-246
THERMAL CAPACITY USED .....	5-143
THERMAL MODEL	
cooling .....	5-152
description .....	5-142
limit curves .....	5-142
setpoints .....	5-142
TIME .....	5-115
TIME BETWEEN STARTS .....	7-237
TRENDING .....	4-87
TRIP COUNTER .....	5-125, 6-209, 6-216
TRIP RELAY .....	3-45
setpoints .....	5-130
TWO PHASE WIRING .....	7-248
TWO WIRE RTD LEAD COMPENSATION .....	7-253
TYPE TEST STANDARDS .....	2-24

---

## U

UNBALANCE	
alarm and trip .....	7-237
bias .....	5-149

bias k factor .....	7-235
bias of thermal capacity .....	7-235
setpoints .....	5-142
test .....	8-265
UNDERCURRENT .....	5-157, 7-237
UNDERFREQUENCY .....	5-175
UNDERPOWER .....	5-182
UNDERVOLTAGE .....	5-171
UPGRADING FIRMWARE .....	4-84

---

## V

VIBRATION .....	2-23
VOLTAGE	
input accuracy test .....	8-257
metering .....	6-207
phase reversal test .....	8-265
VOLTAGE TRANSFORMER	
see VT	
VT	
connection type .....	5-123
ratio .....	5-123
VT RATIO .....	5-122, 5-123
VT SETTINGS .....	7-234

---

## W

WARRANTY .....	A-275
WAVEFORM CAPTURE .....	2-16, 5-116, 5-185
setpoints .....	5-116, 5-118
WIRING DIAGRAM .....	3-37

---

## Z

ZERO SEQUENCE	
ground CT placement .....	3-40

